

# Orthopedic /Spinal Sourcebook

## SURGICAL INSTRUMENTS CATALOG

German Engineering. American Design. World-Class Quality.

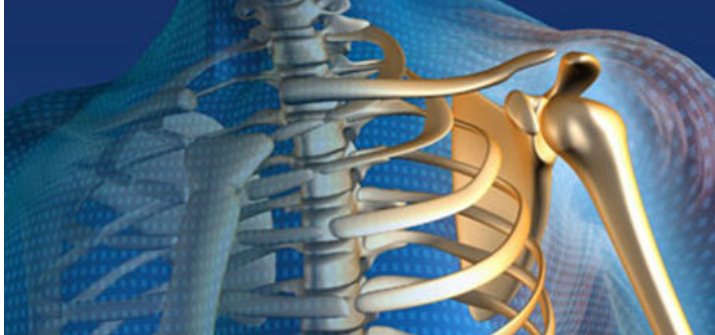

## GENERAL INFORMATION

Pilling® and KMedic® Surgical Instruments . . . . .	7
Customer Service . . . . .	8
Guarantee/Warranty . . . . .	9
Care and Cleaning . . . . .	10
Policies and Procedures . . . . .	11
Trademarks . . . . .	12
Instrumentation Services . . . . .	13
N-Compass™ Instrument Management System . . . . .	14
Scales and Gauges . . . . .	16
Measuring Guidelines and Common Jaw Patterns of Surgical Instruments . . . . .	18

## GENERAL INSTRUMENTS AND PRODUCTS

Overview . . . . .	20
Knife Handles . . . . .	22
Forceps and Clamps . . . . .	25
Scissors . . . . .	101
Needle Holders . . . . .	150
Retractors, Hand-Held . . . . .	185
Retractors, Self-Retaining . . . . .	216
Retractors, Table-Mounted . . . . .	238
Suction Tubes . . . . .	243
Extended Length/Open Bariatric . . . . .	249
OB/GYN . . . . .	262
Urology . . . . .	292
Rectal . . . . .	298
Miscellaneous General . . . . .	307
Micro Clips and Applicators . . . . .	315
Instrument Accessories . . . . .	322
Floor Grade Instruments . . . . .	349
Specialty Sponges . . . . .	357
Weck® Specialty Products . . . . .	367
Container Systems . . . . .	368
Weck® Ligation Solutions . . . . .	373

## EAR, NOSE AND THROAT INSTRUMENTS

Overview . . . . .	386
Laryngoscopes . . . . .	388
Subglottoscopes . . . . .	406
Instrumentation for Laryngoscopes . . . . .	416
Bronchoscopes . . . . .	437
Telescopes and Accessories . . . . .	442
Rigid Endoscope/Telescope Compatibility Chart . . . . .	444
Esophagoscopes . . . . .	446
Instrumentation for Bronchoscopes and Esophagoscopes . . . . .	451
Fiber Optic Cables . . . . .	463





Bougies/Dilators . . . . .	465
Tracheostomy Tubes . . . . .	469
Ear Instruments . . . . .	493
Nasal Instruments . . . . .	503
Mouth and Throat Instruments . . . . .	521
Scope and Light Carriers Identification Index . . . . .	534

## CARDIAC, VASCULAR AND THORACIC INSTRUMENTS

Overview . . . . .	542
CVT Forceps and Clamps . . . . .	544
Bulldog® and Micro Vessel Clamps . . . . .	560
Pilling® Vascular Clamps . . . . .	573
Vascular Clamps . . . . .	575
Aortic Vascular Clamps . . . . .	628
Scissors . . . . .	656
CVT Needle Holders . . . . .	674
Titanium Instruments: Forceps and Clamps . . . . .	686
Titanium Instruments: Scissors . . . . .	704
Titanium Instruments: Needle Holders . . . . .	707
Rib Instruments . . . . .	714
CVT Retractors . . . . .	720
Valve Instruments . . . . .	751
Aortic Punches . . . . .	762
Heparin Cannulae . . . . .	764
Suction Tubes . . . . .	765
Vascular Dilators . . . . .	768
Valvulotomes . . . . .	772
Mediastinoscopy . . . . .	774
Video-Assisted Thoracoscopy . . . . .	780
Miscellaneous CVT . . . . .	793
Specialty Sets . . . . .	798

## ORTHOPEDIC INSTRUMENTS

Overview . . . . .	804
KMedic® Wire And Pin Implants . . . . .	806
Kirschner Wires, Steinmann Pin, Vickers K-Wire Dispensers . . . . .	809
Vickers Easidriver . . . . .	812
KMedic® Gratloch™ Wire Bender . . . . .	814
Wire Twisters And Wire/Pin/Rod Cutters . . . . .	816
KMedic® Corwin Wire Twister . . . . .	819
KMedic® P.I. Wire Twister And Tightener . . . . .	820
KMedic® Jet Wire Twister . . . . .	821
About KMedic® Wire And Pin Cutters . . . . .	822
KMedic® Large Pin Cutter . . . . .	830
KMedic® Cable Cutter . . . . .	832
Table Top Rod Cutter . . . . .	834
Pliers . . . . .	835



Wire Guides and Traction Bows . . . . .	848
Ligature Carriers and Wire Passers . . . . .	849
Drills, Drill Bits and Guides . . . . .	850
KMedic® Drill Bit Sterilization Case . . . . .	857
Trephines . . . . .	868
Screw Drivers . . . . .	869
Bending Irons and Rod Holders . . . . .	877
Orthopedic Retractors . . . . .	882
Vickers Finger Retractor . . . . .	899
Bone Holding Instruments . . . . .	918
Bone Hooks and Awls . . . . .	942
Cartilage and Tendon Instruments . . . . .	946
Dissectors and Elevators . . . . .	953
Bone Files and Rasps . . . . .	970
Curettes . . . . .	979
Osteotomes . . . . .	992
Smartracks for Osteotomes . . . . .	1001
Chisels and Gouges . . . . .	1002
Bone Tamps and Impactors . . . . .	1009
Mallets . . . . .	1011
Bone Cutting Forceps . . . . .	1019
Rongeurs . . . . .	1023
KMedic® Spinal Rongeurs and Punches . . . . .	1045
KMedic® Cleanpunch® Rongeurs . . . . .	1047
TL Spinal Implant Removal System . . . . .	1066
Nail Instruments . . . . .	1068
Bone Saws and Knives . . . . .	1075
Plaster Cast Instruments . . . . .	1078
Measuring Devices . . . . .	1082
Smartracks . . . . .	1085
Specialty Trays . . . . .	1090
Miscellaneous Orthopedic . . . . .	1091

## OPHTHALMIC INSTRUMENTS

Overview . . . . .	1100
Forceps . . . . .	1102
Scissors . . . . .	1112
Needle Holders . . . . .	1121
Hooks . . . . .	1122
Curettes . . . . .	1124
Knives . . . . .	1125
Specula . . . . .	1125
Lacrimal Probes/Dilators . . . . .	1126
Eye Spuds/Needles . . . . .	1127
Irrigation Cannula . . . . .	1128
Calipers . . . . .	1130
Cutting Block . . . . .	1130
Eye Shields . . . . .	1131





## LAPAROSCOPIC INSTRUMENTS

Overview . . . . .	1132
Handle Types . . . . .	1134
5 mm Dissectors, Grasping Forceps . . . . .	1135
10 mm Dissectors . . . . .	1138
5-10 mm Biopsy Forceps . . . . .	1139
5 mm Bipolar Forceps . . . . .	1141
5 mm Ratcheted Graspers . . . . .	1142
5 mm Needle Holders . . . . .	1147
5 mm Scissors . . . . .	1148
Trays . . . . .	1149
Electrodes and Coagulators . . . . .	1150
Verres Needles . . . . .	1151
Cannulas . . . . .	1151
Probes . . . . .	1151
Knot Pushers . . . . .	1151
Telescopes . . . . .	1152
Retractors . . . . .	1152

## ELECTROSURGICAL INSTRUMENTS

Overview . . . . .	1154
Biceps Non-stick Bipolar Forceps and Cords . . . . .	1156
Biceps Forceps and Cords . . . . .	1157
Disposable Electrodes . . . . .	1159
Electrodes . . . . .	1160
Monopolar Handswitching Forceps . . . . .	1160
Coagulation Suction Tubes . . . . .	1161

## ADDITIONAL SURGICAL PRODUCTS

Overview . . . . .	1162
Deklene® Maxx™ Polypropylene Suture . . . . .	1164
Tevdek®/Polydek® Braided Polyester Suture . . . . .	1164
NextStitch® Valve Suture . . . . .	1164
Gabbay Frater Suture Organizer . . . . .	1164
Taut® Cholangiography Catheters . . . . .	1165
Taut® System One™ Common Bile Duct Exploration Kit . . . . .	1166
Weck Vista® Bladeless Laparoscopic Access Ports . . . . .	1167
Weck EFX™ Endo Fascial Closure System . . . . .	1168
Weck® Visistat® Fixed Head Skin Staplers . . . . .	1169
Weck® Rotating Head Skin Stapler . . . . .	1169
Weck® Skin Staple Extractors . . . . .	1169
INDEX . . . . .	1170









# PILLING® AND KMEDIC® SURGICAL INSTRUMENTS

Quality that builds confidence

For nearly 200 years, Pilling® quality instruments have been provided to surgeons across the world to help improve the standard of patient care. The Pilling® Brand is especially known globally in the CVT and ENT specialties with numerous proprietary instruments co-developed with leading surgeons in these fields.

George P. Pilling joined a company started in 1814 that fashioned jewelry and fraternal emblems and guided the business into a new role. As hospitals in the Philadelphia, Pennsylvania area needed new tools to provide improved care for their patients, the Pilling Company met that important need and established itself as the oldest surgical instrument manufacturer in the United States.

Today, the Pilling® Brand is an important part of the Teleflex® Brand portfolio, and continues its legacy in providing high quality, hand-crafted instrumentation that meets the surgeon's requirements.

Over the years, the Pilling® Brand has maintained high standards of quality and continues to emphasize customer service and satisfaction. As surgical procedural needs change, specialty surgeons can count on Pilling® branded instruments to meet their new requirements.

KMedic®, another member of the Teleflex® Family of brands, offers the most extensive line of orthopedic instruments with more than 2,000 patterns. Just like our Pilling® brand, our KMedic® Line of orthopedic instruments conform to the highest standards of precision and reliability, consistency of pattern and lasting value.



# PILLING® AND KMEDIC®

American designed. German engineered. World-class quality.

Pilling® and KMedic® Branded surgical instruments are made from 100% German and U.S. forgings to ensure the highest quality and impeccable functionality. These instruments are fully guaranteed for the quality of material and workmanship and has been subjected to an established quality control process that consists of a comprehensive product inspection that verifies the form, fit, and function of all the instruments.

Pilling® Forceps and Scissors are made of the finest stainless steel, processed to obtain optimum corrosion resistance, resilience and strength.

Ratchets on Pilling® Vascular Clamps provide indispensable finite control for arterial clamping. Ratchets are designed with the steps (1 x 7, 1 x 9, 1 x 11) to furnish the specific amounts of required compression.

Pilling® DeBakey® Jaws are designed to clamp and hold without slipping. Cardiovascular clamps featuring these jaws will grip tissue delicately but firmly, or will completely occlude a vessel, reducing the danger of crushing or causing undue damage to the intima.

The LIFE-LOK® Box Lock construction of all Pilling® Vascular Clamps and a growing assortment of general instruments have virtually eliminated cracked and

broken box locks. This major improvement materially prolongs the useful life of these expensive instruments and reduces the necessity for repair or replacement.

We are able to provide **laser surface or ebonized finishes** for most stainless steel instruments to provide the appropriate reflection-lowering finish for their use in laser surgery.

**We continually strive to improve our products, therefore changes may result. All specifications and measurements in this Catalog may vary within accepted industry standards or change without notice. Teleflex® will not be responsible for any printing errors contained herein.**

**Measurements given in our Catalog refer to overall length, unless specified otherwise.**

**Reproduction of illustrations or descriptions is prohibited without the express written consent of Teleflex®.**

*For more information on Pilling® and KMedic® Products, or to place an order, contact Customer Service at 866-246-6990.*





# PILLING® AND KMEDIC® SURGICAL INSTRUMENTS

## Guarantee/Warranty

This warranty information may be modified from time to time by Teleflex®. Please check the Pilling® Instruments on-line catalog website for the most current warranty information: [Pillinginstruments.com](http://Pillinginstruments.com)

Except as provided below, all surgical instruments stamped or etched with the Pilling® or KMedic® Brand shall be free from manufacturing defects in material or workmanship for the life of the instrument. Teleflex®'s sole responsibility under all warranty shall be, at Teleflex®'s option, to either repair, replace, or refurbish any instrument proving defective, free of charge. Teleflex® makes no warranty with respect to In-Ex branded instruments, lenses, malleable items, micro instruments, bougies and disposable products. This guarantee is void if instruments are not maintained or repaired properly, or if they are not used for their intended surgical purpose.

### LIFE-LOK® BOX-LOCK

Pilling® Instruments that feature the LIFE-LOK® box-lock are warranted not to break or crack in the box lock area due to stress buildup for the life of the instrument.

### NEEDLE HOLDERS

Pilling® Needle Holders containing Tungsten Carbide (TC) inserts are warranted against cracking or fragmenting in the jaw for (3) years.

### TUNGSTEN CARBIDE INSERTS

KMedic® Scissors, Needle Holders and Wire Cutters that obtain Tungsten Carbide (TC) inserts, are guaranteed for (3) years. Replacement parts, such as springs, are guaranteed for (1) year.

### NON-DISPOSABLE LAPAROSCOPIC INSTRUMENTS

Pilling® Non-Disposable Laparoscopic Instruments are warranted against failure in normal use for one (1) year. This warranty does not cover routine sharpening or refurbishment, or repair of damage caused by misuse.

The above warranties are contingent upon the proper maintenance and use of the instruments and do not cover instruments that have been modified without Teleflex®'s approval or which have been subjected to unusual stress, or on which the original identification marks have been removed or altered.

### TELESCOPES AND LIGHT CARRIERS

All light carriers and Rod Lens Telescopes etched with the Pilling® Name shall be free from manufacturing defects in material or workmanship. Any parts proving defective in the first 12 months of ownership will be serviced, repaired or replaced at Teleflex®'s option, free of charge.

This limited warranty is the only warranty provided by Teleflex®. Teleflex® disclaims all other warranties, either express or implied, including but not limited to implied warranties of merchantability and fitness for particular purpose. In no event shall Teleflex® have any liability for indirect, consequential, special, incidental or punitive damages, however caused, on any theory of liability and whether or not it has been advised of the possibility of such damages.



# CARE AND CLEANING

High quality surgical instruments are typically made from surgical grade stainless steel (i.e., 410, 420 etc.). The grade varies by manufacturer and by type of instrument. For example, a scissor may be fabricated of 420 stainless steel to enable the blades to be hardened adequately for long life. A forceps on the other hand usually does not require the same hardness, and may be fabricated from a 410 grade.

Malleable retractors are made of yet another grade. The grade of stainless steel selected for specific instruments is critical for long serviceability. The grade of steel reflects its hardness and its resistance to corrosion. Unfortunately, there is an inverse relationship, that is, the more the steel can be hardened, the greater its susceptibility to corrosion.

In an effort to reduce corrosion problems, Teleflex® specially treats (passivates) its instruments to make the surface less chemically active with its environment. All Weck® Instruments feature this special high gloss finish. This finish reduces the number of pits in the instrument, which in turn reduces the number of sites where corrosion can occur. These steps are necessary due to the environment, which is very harsh as a consequence of the composition of blood and other fluids, the chemicals used to clean and disinfect the instruments, and finally the methods used to sterilize them.

## USE

Use instruments for their intended purpose only.

## CLEANING

Instruments should be thoroughly cleaned with cleaners such as: Wec-Kleen®, Weck® Liquid Detergent, Weck Instrument Cleaner or Wec-Wash® as soon as possible after use. Once blood or other foreign matter has dried, removal is very difficult.

If left in place these contaminants can provide sites for corrosion to begin. Distilled water (pH near 7) is recommended for soaking and cleaning instruments. If cleaning manually, avoid use of wire brushes or abrasive powders as these can create sites for corrosion. An ultrasonic cleaner is recommended.

## CARE

After a thorough cleaning, instruments with moving parts should be lubricated using a product such as Weck-Lube® or Wec-Kreem® to keep surfaces lubricated. It is important to use water soluble lubricating agents only.

## STERILIZATION

The use of repeated flash cycles is damaging to instruments, therefore a standard steam cycle is preferred. Instruments should be arranged in an open position and instruments fabricated from different metals should be separated to avoid electrochemical reactions. Refer to the sterilizer manufacturer's instructions and AORN guidelines for proper sterilization techniques.

## MAINTENANCE

Routine inspection for damaged tips, jaw alignment, loose box-locks, and worn or damaged ratchets can identify problems. If caught early these problems can often be repaired at a much lower cost than the replacement price of an instrument which has become damaged beyond repair. Contact your Teleflex® Sales Representative to see the Weck® Care and Cleaning Products, set up an instrument inspection program, and review our extensive repair capabilities.

*To locate Instructions For Use (IFU) and Cleaning and Sterilization Instructions for Pilling® Instruments, go to: [www.teleflex.com/ifu](http://www.teleflex.com/ifu).*



# POLICIES AND PROCEDURES

## REFURBISHING/REPAIR SERVICE

Even the finest surgical instruments may need to be repaired or refurbished. Teleflex® recognizes the need to provide rapid responses and quick turnaround times in these situations.

We accept all brands and types of surgical instruments in need of refurbishment or repair. To expedite your repair, include hospital name and address, department to return, and a contact name and phone number. Any surgical instrument which needs refurbishing or repair, regardless of manufacturer, should be forwarded to:

Teleflex®  
Surgical Instrument Repair  
4177 Varsity Drive Unit B  
Ann Arbor, MI 48108  
(877) TFX- RPR1  
(877) 839-7771

## TERMS AND CONDITIONS

Standard terms are: net 30 days; F.O.B. shipping point, unless otherwise approved in writing by Teleflex®.

All orders are subject to approval and acceptance by Teleflex®.

Teleflex® reserves the right to alter or suspend credit, refuse shipment or cancel unfilled orders, when credit conditions or delivery delays from the customer warrant such action.

## PARTIAL SHIPMENTS AND SPECIAL ORDERS

Due to demand for certain products, Teleflex® cannot guarantee that every product will be available for immediate shipment. If a back order situation occurs, partial shipment will be made where possible. Your invoice will indicate any product on back order.

If partial shipments are not acceptable or practical, we will make every effort to ship the complete order at the earliest possible time.

Certain products are built to order and are subject to availability of raw materials. These products may require longer lead times.

## RETURN GOODS POLICY

All returns must be accompanied by a "Return Goods Authorization Number" which is available by calling our Customer Service Department at 866-246-6990. Teleflex®'s invoice number, order number and date of receipt of goods must be supplied to customer service in order to obtain a return goods number.

All returns must be made within sixty (60) days of invoice date. The products must be unused and in the original packaging.

Returned goods must be shipped prepaid to:  
Teleflex®  
11425 N. Distribution Cove  
Olive Branch, MS 38654

The goods should also be accompanied by a copy of the invoice or packing list and a return goods authorization number. All returns are subject to the Teleflex® instrument's inspection and acceptance. There will be a \$5.00 per instrument charge for removal of etching applied at the customer's request. The following items are non-returnable, other than for a manufacturing defect:

- Sterilized products
- Discontinued products
- Engraved instruments or instruments etched by hospital
- Instruments returned after sixty (60) days of invoice date
- Custom or modified items
- Silicone goods
- Disposable products





## TELEFLEX® TRADEMARKS

# Pilling®

BICEPS®	WEC-JAW®
BULLDOG®	WEC-KLEEN®
CLEAR ADVANTAGE®	WECK-LUBE®
DIGITATE®	WEC-PEN FTC®
HEMOCLIP®	WEC-WASH®
CLEANPUNCH®	WECK®
HEM-O-LOK®	KAISER-PILLING®
IDENTI-LOOPS®	K-P®
LIFE-LOK®	KLINTMALM™
PILLING®	MAKI™
KMEDIC®	MCDUGAL™
PLASTI STATS®	N-COMPASS™
TECHNIQUE®	WECK-RACK™
VISISTAT®	





雄鷹有限公司  
ASIA EAGLE CO., LTD.

Pilling®

Teleflex Medical

KMedic



Address: 台北市大安區仁愛路  
四段300巷27號1樓

Tel: 02-27089959

Toll Free: 0800-082-001

Order Email: [service@asiaeagle.com.tw](mailto:service@asiaeagle.com.tw)  
林群雄 0988-670-709

Teleflex®  
MEDICAL

# INSTRUMENTATION SERVICES

In addition to providing our customers with a comprehensive product line of surgical instruments, Teleflex® also offers the following programs and services:

- N-COMPASS™ Instrument Management System
- Repair Service
- Custom Instruments Service
- Complimentary Instrument Etching
- Special Instrument Finishes

*For more information on these services, please contact your Teleflex® Surgical Sales Specialist or customer service at 866.246.6990.*

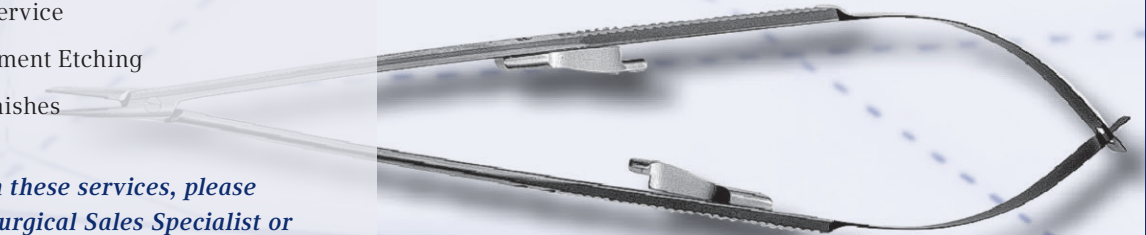



# N-COMPASS™ INSTRUMENT MANAGEMENT SYSTEM

Your Path To Total Instrument Management

## THE N-COMPASS SYSTEM SAVES TIME AND MONEY BY:

- Minimizing risk of errors in instrument set assembly, which can help reduce OR schedule delays
- Enabling Central Processing staff to locate instruments by providing offering the functionality to search hospital inventory
- Identifies frequently used instrument sets and helps you manage inventory relative to case volume
- Minimizing risk of purchasing errors and increased requisition processing time by clear identification of instrument requirements and vendors

## THE N-COMPASS SYSTEM PUTS YOU IN CONTROL: CUSTOMIZE COUNT SHEETS

- Use and update easily
- Include images of each instrument and the assembled instrument set
- Customize to your specific needs
- Make and save global instrument changes

## INSTRUMENT LOCATOR

- Search by catalog number, description, or vendor
- Search set inventory to locate a specific instrument eliminating the need to open sets

## INSTRUMENT REPAIR RECORDS

- Generate instrument/equipment repair reports
- Review repair status
- Create repair/replacement requisitions automatically

## INSTRUMENT INVENTORY

- Produce a complete instrument inventory
- Sort instrument inventory by instrument type, catalog number, description, vendor, set name, and surgical specialty

## DIGITAL IMAGE DATABASE

- More than 20,000 individual instrument images at your fingertips
- Import assembled set images
- Save time and reduce errors in new and replacement instrument ordering
- Train new employees more easily with identified instruments and sets







#### CROSS REFERENCE LIST

- Simplify instrument ordering by cross referencing instruments with leading suppliers

#### PRICING/BUDGETING

- Dollar values for each instrument, set, and specialty
- Easy access to pricing to assist in budgeting and financial planning

#### REPORTS

- Generate staff productivity and set use reports
- Track data on set usage to help identify both high and low set usage

#### N-COMPASS SERVICES PROVIDED BY TELEFLEX:

- Software installation
- On-site physical set inventory
- Data entry and verification
- Digital images of Pilling®, Weck® and KMedic® Instruments
- Standardization of instrument patterns
- Customized count sheets
- On-site training



# SCALES AND GAUGES

## CONVERSION SCALE

TO CONVERT FROM	TO	MULTIPLY BY
Ounces (AVDP.)	Grams	28.349523
Ounces (APOTH.)	Grams	31.103486
Grains	Grams	0.06479891
Pounds (AVDP.)	Kilograms	0.45359237
Inches	Centimeters	2.54
Feet	Meters	0.3048
Yards	Meters	0.9144
Ounces (U.S. Fluid)	Cubic Centimeters	29.573730
Ounces (British Fluid)	Cubic Centimeters	28.41305
Quarts (U.S. Fluid)	Liters	0.9463264
Cubic Inches	Cubic Centimeters	16.387064
Grams	Grains	15.432358
Grams	Ounces (AVDP.)	0.35273962
Grams	Ounces (APOTH.)	0.32150737
Kilograms	Pounds (AVDP.)	2.2046226
Millimeters	Inches	0.039370079
Centimeters	Inches	0.39370079
Meters	Feet	3.2808399
Cubic Centimeters	Cubic Inches	0.61023744
Cubic Centimeters (Fluid)	Ounces (U.S. Fluid)	0.33814023
Liters	Quarts (U.S. Fluid)	1.056718

## FAHRENHEIT AND CENTIGRADE SCALES

F°	C°
500	260
401	205
392	200
383	195
374	190
356	180
347	175
338	170
329	165
320	160
311	155
302	150
284	140
275	135
266	130
248	120
239	115
230	110
212	100
203	95
194	90
176	80
167	75
140	60
122	50
113	45
105	40.56
104	40
104	40
100	37.8
98.5	36.9
95	35
86	30
77	25
68	20
50	10
41	5
32	0
23	-5
14	-10
+5	-15
-4	-20
-13	-25
-22	-30
-40	-40
-76	-60



# SCALES AND GAUGES

## COMPARATIVE SCALES OR GAUGES

DIAMETERS IN MILLIMETERS	AMERICAN	FRENCH	ENGLISH
1/3		1	
1/2	1		
2/3		2	
1	2	3	
1-1/3		4	
1-1/2	3		
1-2/3		5	
2	4	6	
2-1/3		7	1
2-1/2	5		
2-2/3		8	2
3	6	9	3
3-1/3		10	
3-1/2	7		
3-2/3		11	4
4	8	12	5
4-1/3		13	
4-1/2	9		
4-2/3		14	
5	10	15	6
5-1/3		16	7
5-1/2	11		
5-2/3		17	8
6	12	18	9
6-1/3		19	10
6-1/2	13		
6-2/3		20	11

DIAMETERS IN MILLIMETERS	AMERICAN	FRENCH	ENGLISH
7	14	21	
7-1/3		22	12
7-1/2	15		
7-2/3		23	13
8	16	24	
8-1/3		25	14
8-1/2	17		
8-2/3		26	15
9	18	27	16
9-1/3		28	17
9-1/2	19		
9-2/3		29	
10	20	30	18
10-1/3		31	19
10-1/2	21		
10-2/3		32	20
11	22	33	21
11-1/3		34	22
11-1/2	23		
11-2/3		35	23
12	24	36	24
12-1/3		37	25
12-1/2	25		
12-2/3		38	26
13	26	39	27
13-1/3		40	28

0 in

1

2

3

4

5

6

7

8



# MEASURING GUIDELINES AND COMMON JAW PATTERNS OF SURGICAL INSTRUMENTS

High quality, handcrafted instrument measurements will vary slightly. Instruments in this catalog are stainless steel unless otherwise noted.

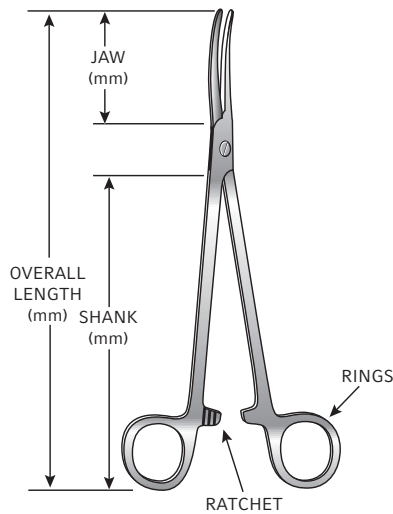

## COMMON JAW SURFACES FOUND ON HEMOSTATS AND CLAMPS

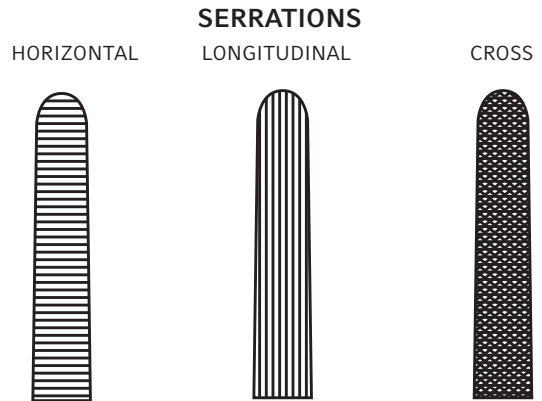

## JAW CURVATURE

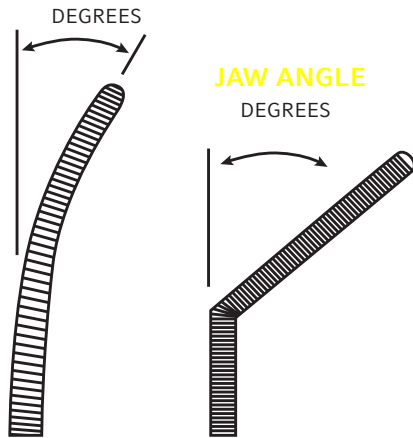

## JAW CROSS SECTIONS

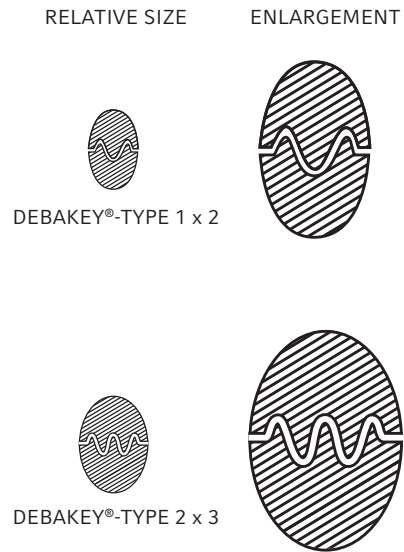

## COMMON SURFACES FOUND ON NEEDLE HOLDERS WITH TUNGSTEN CARBIDE INSERTS

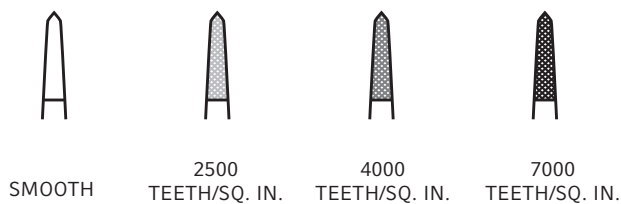



FROM INNER SURFACE OF SIDE BLADES

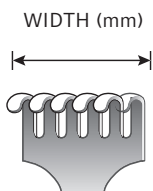
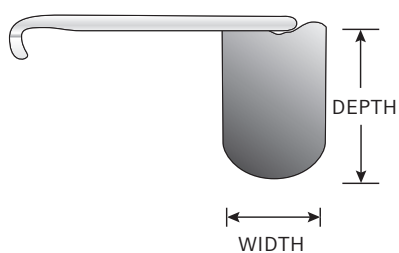
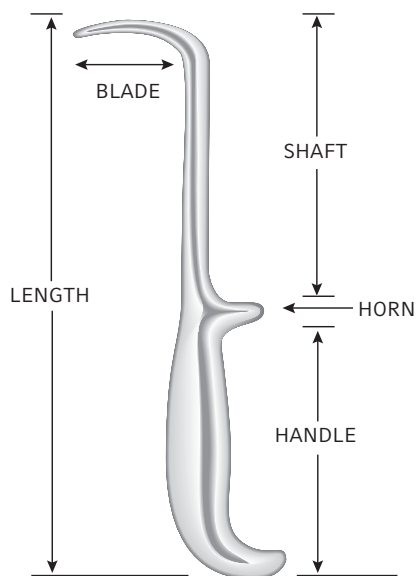
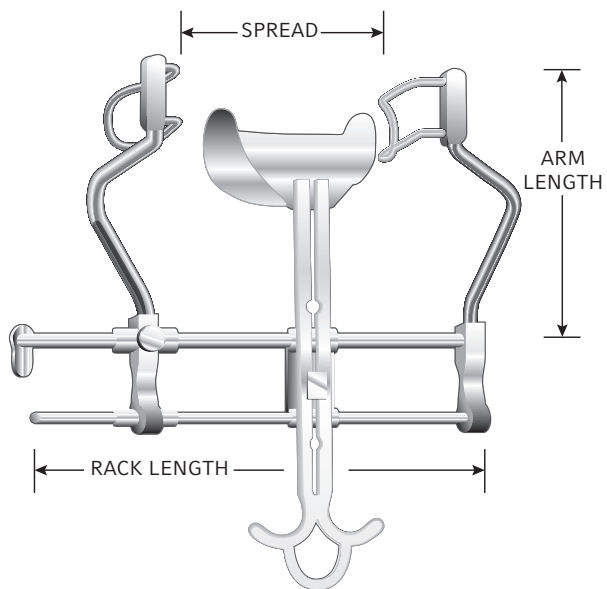

RING HANDLE

BLADE LENGTH

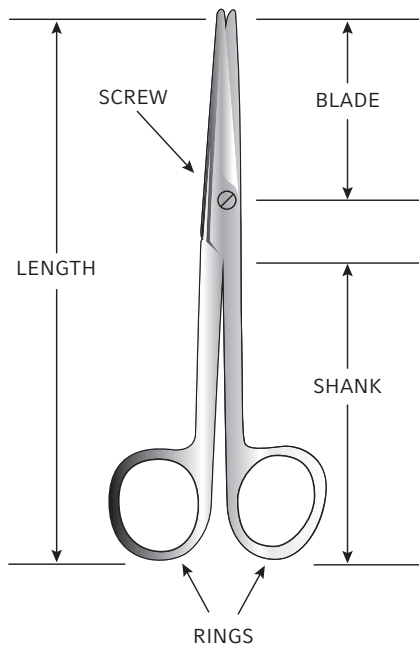
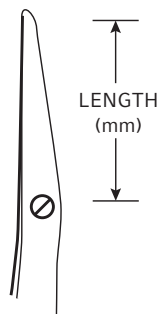

BLADE CURVATURE

DEGREES

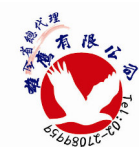



雄鷹有限公司  
ASIA EAGLE CO., LTD.



Pilling®

Teleflex Medical

KMedic



Address: 台北市大安區仁愛路  
四段300巷27號1樓

Tel: 02-27089959

Toll Free: 0800-082-001

Order Email: [service@asiaeagle.com.tw](mailto:service@asiaeagle.com.tw)  
林群雄 0988-670-709

Teleflex®  
MEDICAL







# ORTHOPEDIC INSTRUMENTS

## CHAPTER OVERVIEW

Pilling® and KMedic® Orthopedic Instruments represent a high-quality line that offers the precision you require, the quality you demand, and the pattern assortments that meet your needs. Our categories of Orthopedic instruments include:

- KMedic® Wire and Pin Implants
- Wire Twisters, and Pin and Rod Cutters
- Pliers, Drills and Screwdrivers
- Rongeurs
- Ostetomes, Chisels and Gouges
- Nail Instruments
- Smartrack Sterilization and Storage Racks







# KMEDIC® WIRE AND PIN IMPLANTS



Bend K-Wires up to 0.062" in diameter easily with our Gratloch Wire Bender KM48370.

## KMEDIC® WIRE AND PIN IMPLANTS

- Precision manufactured in Germany from certified implant stainless steel.
- Longer, gently tapered points for easier penetration.
- Smoothly hand-polished, causing less trauma when removed.
- K-Wires and Steinmann pins are sold six (6) per package.

Please inquire about availability of any sizes and styles not shown.



Trocar Point



Diamond Point

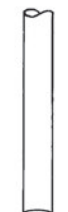









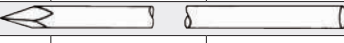

Round End











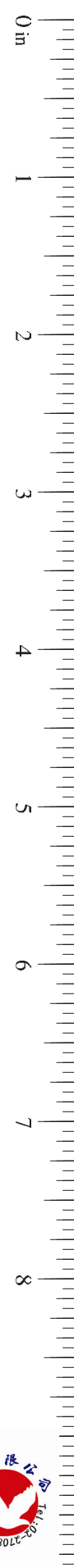

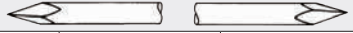

3 Shank End



KIRSCHNER WIRES (SMOOTH) — PKG/6					
LENGTH	0.028" (.7 mm)	0.035" (.9 mm)	0.045" (1.1 mm)	0.054" (1.4 mm)	0.062" (1.6 mm)
<b>DOUBLE END TROCAR</b> 					
4"	KM71100	KM71101	KM71102	KM71104	KM71103
5"	KM71105	KM71106	KM71107	KM71108	KM71109
6"	KM71021	KM71022	KM71023	KM71024	KM71025
9"	KM71110	KM71111	KM71112	KM71114	KM71113
12"	KM71120	KM71121	KM71122	KM71124	KM71123
<b>SINGLE TROCAR (ROUND END)</b> 					
4"	KM71130	KM71131	KM71132	KM71133	KM71134
5"	KM71170	KM71171	KM71172	KM71174	KM71175
6"	—	—	KM71182	—	KM71185
7"	—	KM71156	—	—	—
9"	KM71150	KM71151	KM71152	KM71154	KM71153
12"	KM71160	KM71161	KM71162	KM71164	KM71163
<b>DOUBLE END DIAMOND</b> 					
4"	KM71200	KM71201	KM71202	KM71203	KM71204
5"	KM71205	KM71206	KM71207	KM71208	KM71209
6"	KM71030	KM71031	KM71032	KM71034	KM71033
9"	KM71210	KM71211	KM71212	KM71214	KM71213
<b>SINGLE DIAMOND (ROUND END)</b> 					
4"	KM71230	KM71231	KM71232	KM71233	KM71234
9"	KM71240	KM71241	KM71242	KM71244	KM71243
12"	KM71250	KM71251	KM71252	KM71254	KM71253
<b>SUTURE PASSER SINGLE DIAMOND WITH SUTURE HOLE (ROUND END)</b> 					
9"	—	—	KM71262	—	KM71263
<b>SUTURE PASSER SINGLE DIAMOND WITH SUTURE HOLE (3 SHANK END)</b> 					
9"	—	—	—	—	—
<b>SINGLE TROCAR (3 SHANK END)</b> 					
9"	—	—	—	—	—
<b>SINGLE DIAMOND (3 SHANK END)</b> 					
9"	—	—	—	—	—
<b>KIRSCHNER WIRES (FULLY THREADED) — PKG/6</b>					
LENGTH	0.028" (.7 mm)	0.035" (.9 mm)	0.045" (1.1 mm)	0.054" (1.4 mm)	0.062" (1.6 mm)
<b>DOUBLE END TROCAR</b> 					
6"	—	KM71290	KM71291	—	KM71293
9"	—	KM71301	KM71302	—	KM71303
<b>SINGLE TROCAR (ROUND END)</b> 					
9"	—	KM71304	KM71305	—	KM71310
<b>DOUBLE END DIAMOND</b> 					
9"	—	KM71311	KM71312	—	KM71313
<b>SINGLE DIAMOND (ROUND END)</b> 					
9"	—	KM71314	KM71315	—	KM71307
10"	—	—	—	—	—





STEINMANN PINS (SMOOTH) — PKG/6							
LENGTH	5/64" (2.0 mm)	3/32" (2.4 mm)	7/64" (2.8 mm)	1/8" (3.2 mm)	9/64" (3.5 mm)	5/32" (4.0 mm)	0.177" (4.5 mm)
<b>DOUBLE END TROCAR</b> 							
4"	—	—	—	—	—	—	—
5"	—	—	—	—	—	—	—
6"	—	—	—	—	—	—	—
9"	KM71450	KM71453	KM71456	KM71459	KM71462	KM71465	KM71468
12"	—	—	—	—	—	—	—
<b>SINGLE TROCAR (ROUND END)</b> 							
4"	—	—	—	—	—	—	—
5"	—	KM71432	—	—	—	—	—
6"	—	—	—	—	—	—	—
7"	—	—	—	KM71434	—	—	—
9"	KM71510	KM71513	KM71516	KM71519	KM71522	KM71525	KM71528
12"	KM71674	KM71676	KM71677	KM71680	KM71681	KM71682	KM71683
<b>DOUBLE END DIAMOND</b> 							
4"	—	—	—	—	—	—	—
5"	—	—	—	—	—	—	—
6"	—	—	—	—	—	—	—
9"	KM71600	KM71603	KM71606	KM71609	KM71612	KM71615	KM71618
<b>SINGLE DIAMOND (ROUND END)</b> 							
4"	—	—	—	—	—	—	—
9"	KM71660	KM71663	KM71666	KM71669	KM71672	KM71675	KM71678
12"	—	—	—	—	—	—	—
<b>SUTURE PASSER SINGLE DIAMOND WITH SUTURE HOLE (ROUND END)</b> 							
9"	—	—	—	—	—	—	—
<b>SUTURE PASSER SINGLE DIAMOND WITH SUTURE HOLE (3 SHANK END)</b> 							
9"	KM71880	KM71883	KM71886	KM71889	KM71892	KM71895	KM71898
<b>SINGLE TROCAR (3 SHANK END)</b> 							
9"	KM71480	KM71483	KM71486	KM71489	KM71492	KM71495	KM71498
<b>SINGLE DIAMOND (3 SHANK END)</b> 							
9"	KM71630	KM71633	KM71636	KM71639	KM71642	KM71645	KM71648
<b>STEINMANN PINS (FULLY THREADED) — PKG/6</b>							
LENGTH	5/64" (2.0 mm)	3/32" (2.4 mm)	7/64" (2.8 mm)	1/8" (3.2 mm)	9/64" (3.5 mm)	5/32" (4.0 mm)	0.177" (4.5 mm)
<b>DOUBLE END TROCAR</b> 							
6"	—	—	—	—	—	—	—
9"	KM71750	KM71753	KM71756	KM71759	KM71762	KM71765	KM71768
<b>SINGLE TROCAR (ROUND END)</b> 							
9"	KM71770	KM71773	KM71776	KM71779	KM71782	KM71785	KM71788
<b>DOUBLE END DIAMOND</b> 							
9"	KM71730	KM71733	KM71736	KM71739	KM71742	KM71745	KM71748
<b>SINGLE DIAMOND (ROUND END)</b> 							
9"	KM71700	KM71703	KM71706	KM71709	KM71712	KM71715	KM71718
10"	—	KM71679	—	—	—	—	—





# KMEDIC® WIRE AND PIN IMPLANTS

STEINMANN PINS CALIBRATED (GUIDE WIRES) WITH 1/2" GRADUATIONS					
LENGTH	0.062" (1.6 mm)	5/64" (2.0 mm)	3/32" (2.4 mm)	7/64" (2.8 mm)	1/8" (3.2 mm)
SINGLE TROCAR (ROUND END)					
9"	KM71173	—	—	—	—
SINGLE TROCAR 3 SHANK END					
9"	—	—	KM71833	—	—
SINGLE DIAMOND 3 SHANK END					
9"	—	—	KM71853	KM71856	KM71859
SINGLE DIAMOND 3 ROUND END					
9"	—	—	KM71873	—	—



KM71009

## K-WIRE, STEINMANN PIN STERILIZATION CASES

KM71009

13" x 5-1/4" x 2" (closed)

Holds 9" K-Wires; 9" Steinmann Pins.

K-WIRES - 1 ROW, HOLDS 4 EACH OF THE FOLLOWING:	
0.028" (0.7 mm)	0.045" (1.1 mm)
0.035" (0.9 mm)	0.062" (1.6 mm)
STEINMANN PINS - 2 ROWS, HOLDS 4 EACH OF THE FOLLOWING:	
5/64" (2.0 mm)	9/64" (3.5 mm)
3/32" (2.4 mm)	5/32" (4.0 mm)
7/64" (2.8 mm)	0.177" (4.5 mm)
1/8" (3.2 mm)	

## K-WIRE, STEINMANN PIN STERILIZATION CASES

KM71010

11-3/4" x 5-1/4" x 2" (closed)

Holds 4", 6" and 9" K-Wires; 9" Steinmann Pins.

K-WIRES - 3 ROWS, HOLDS 4 EACH OF THE FOLLOWING:	
0.028" (0.7 mm)	0.045" (1.1 mm)
0.035" (0.9 mm)	0.062" (1.6 mm)
STEINMANN PINS - 1 ROW, HOLDS 2 EACH OF THE FOLLOWING:	
5/64" (2.0 mm)	9/64" (3.5 mm)
3/32" (2.4 mm)	5/32" (4.0 mm)
7/64" (2.8 mm)	0.177" (4.5 mm)
1/8" (3.2 mm)	



# KIRSCHNER WIRES, STEINMANN PIN, VICKERS K-WIRE DISPENSERS

K-WIRE DISPENSER 6-1/4"			
PART NO.	LENGTH	DIAMETER	QTY. HELD
KM71001	up to 6"	0.031" (0.8 mm)	100
KM71002	up to 6"	0.039" (1.0 mm)	50
KM71003	up to 6"	0.047" (1.2 mm)	40
KM71004	up to 6"	0.054" (1.4 mm)	25
KM71006	up to 6"	0.062" (1.6 mm)	20
K-WIRE DISPENSER 12-1/4"			
KM71012	up to 12"	0.039" (1.0 mm)	50
KM71013	up to 12"	0.047" (1.2 mm)	40
KM71014	up to 12"	0.054" (1.4 mm)	25
KM71016	up to 12"	0.062" (1.6 mm)	20
STEINMANN PIN DISPENSER 12-1/4"			
KM71017	up to 12"	5/64" (2.0 mm)	10
KM71019	up to 12"	3/32" (2.5 mm)	5

- Stores and dispenses one size at a time.
- Sharp points are protected by silicone insert in cap.
- To avoid injury, load wire with blunt end down.
- Hexagonal shape of cap prevents unwanted movement of dispenser.
- Diameter is marked for easy identification.



KM71001 - KM71006  
For K-Wire up to 6" long.



KM71012 - KM71019  
For K-Wire and pins up to 12" long. Plastic cap.

VICKERS K-WIRE DISPENSER									
PART NO.	LENGTH	CHAMBER #1		CHAMBER #2		CHAMBER #3		CHAMBER #4	
		DIAMETER	QTY. HELD	DIAMETER	QTY. HELD	DIAMETER	QTY. HELD	DIAMETER	QTY. HELD
KM46542	4"	0.039" (1.0 mm)	60	0.047" (1.2 mm)	40	0.055" (1.4 mm)	30	0.063" (1.6 mm)	18
KM46538	12"	0.039" (1.0 mm)	60	0.047" (1.2 mm)	40	0.055" (1.4 mm)	30	0.063" (1.6 mm)	18
KM46539	12"	0.070" (1.8 mm)	15	5/64" (2.0 mm)	12	0.086" (2.2 mm)	10	3/32" (2.5 mm)	8

- Easily stores and dispenses four different size wires.
- Dial on bottom enables for dispensing of one size at a time.
- To avoid injury, load wire with blunt end down.
- Dial can be locked to avoid accidental dispensing.
- Clearly marked chambers help to avoid mix-up.
- Dispenser is available exclusively from Teleflex®.



KM46542  
For 4" K-Wire.



KM46538 - KM46539  
For 12" K-Wire.







# KMEDIC® WIRE AND PIN IMPLANTS

## Shanz Pins

### SCHANZ PINS (PARTIALLY THREADED)



ITEM #	OVERALL LENGTH	THREAD LENGTH	DIAMETER
KM72220	5-7/8" (150 mm)	1.97" (50 mm)	5 mm
KM72222	6-3/4" (170 mm)	1.97" (50 mm)	5 mm
KM72230	7-1/2" (190 mm)	1.97" (50 mm)	5 mm
KM72224	7-7/8" (200 mm)	1.97" (50 mm)	5 mm
KM72226	10" (254 mm)	1.97" (50 mm)	5 mm



# KMEDIC® WIRE AND PIN IMPLANTS

Wire and Pin Drivers and Benders

## K-WIRE BENDER



KM49802

Bends up to 1.6 mm (0.062") K-Wire to 90 degree angle.

ITEM #	DESCRIPTION
KM49802	3 prong, 5-3/4" (14.5 cm)

## K-WIRE AND PLATE BENDER



KM49724

Bends mini plates and up to 1.1 mm (0.045") K-Wire to 90 degree angle.

ITEM #	DESCRIPTION
KM49724	3 prong, 5" (12.5 cm)



# VICKERS EASIDRIVER

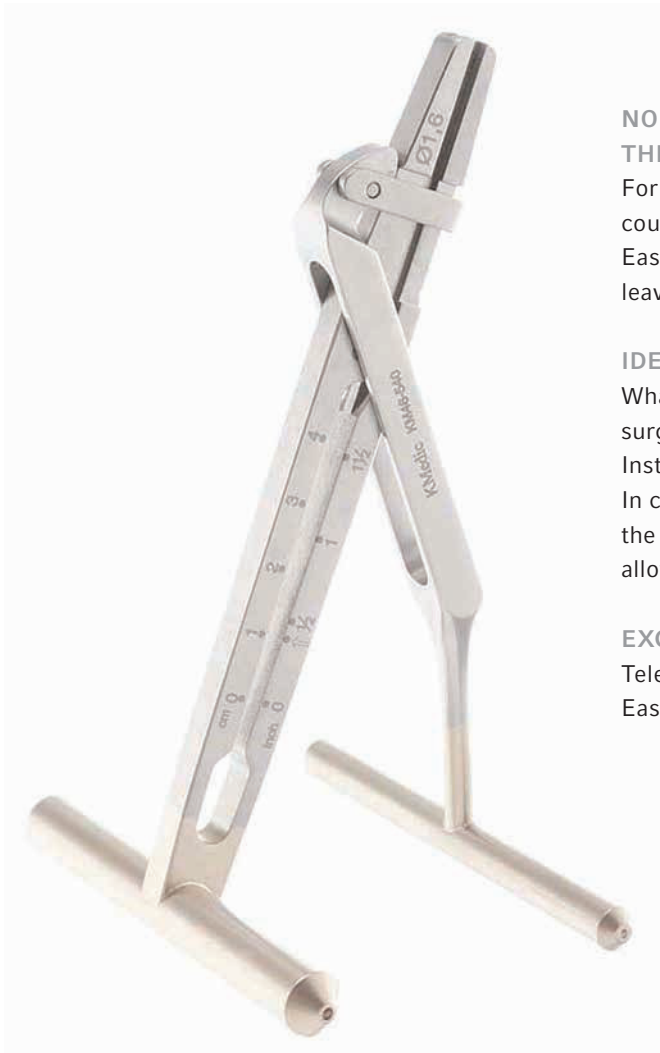

## NO MANUAL DEVICE HAS EVER ACHIEVED THIS FUNCTION

For years, surgeons have sought a simple pin driver that could actually be fully controlled with one hand. The Vickers Easidriver leaves the other hand free to manipulate tissue, leaving the patient in better hands.

## IDEAL BACKUP UNIT FOR OFFICE AND HOSPITAL

What do you use when your power equipment fails during surgery? Now you have the handy Vickers Easidriver Instrument. Without loss of precious time, it is ready for use. In cases where power equipment is not indicated or available, the Vickers Instrument can become your primary driver, allowing for feel and control that power units don't offer.

## EXCLUSIVELY FROM TELEFLEX®

Teleflex® is proud to be able to offer the Vickers Easidriver Instrument.

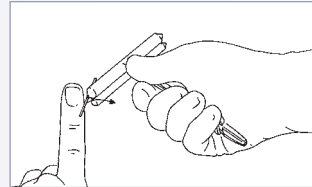
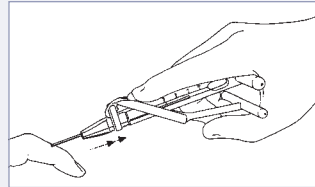
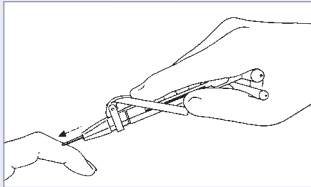

Now you can drive, bend and pull K-Wire for a fraction of the cost of power equipment.

## VICKERS EASIDRIVER INSTRUMENT

KM46540  
5-1/2"  
German Stainless

- Single handed operation
- Chuckless
- Depthscale
- Wire bending facility
- No maintenance
- No set-up
- Autoclavable
- For wire from 0.028" to 0.062"





# KMEDIC® WIRE AND PIN IMPLANTS

Wire and Pin Drivers and Benders

## STEINMAN PIN CHUCK



KM48374

For insertion and removal of Steinmann Pins. Includes chuck key. Cannulation accepts wires and pins up to 0.236" (6.0 mm). Chuck accepts wires and pins up to 1/4" (6.35 mm).

ITEM #	DESCRIPTION
KM48374	Fully cannulated, 4" (10 cm)

## UNIVERSAL CHUCK WITH T-HANDLE



KM47901

No more lost keys! Keyless chuck for insertion and removal of Steinmann Pins. Cannulation accepts wires and pins up to 0.236" (6.0 mm). Chuck accepts wires and pins up to 1/4" (6.35 mm).

ITEM #	DESCRIPTION
KM47901	Fully cannulated with reverse lock, 4-1/2" (11.5 cm)
KM47903	Fully cannulated, 4" (10 cm)





# KMEDIC® GRATLOCH™ WIRE BENDER

The KMedic® Gratloch™ Wire Bender is designed to enable single-handed stabilization and bending of a Kirschner wire simultaneously. The unique design allows K-Wire to be bent close to the bone without sacrificing fracture or osteotomy stability.

## TO BEND WIRE:

1. After the insertion of K-Wire in the bone, cut the wire, leaving a piece of 1/2" to 3/4" in length.
2. Insert the K-Wire into angled slot of Gratloch™ Bender as close to the bone as possible.
3. Press handles to bend wire (0.062" wire will bend 90 degrees; smaller diameters will bend slightly less than 90 degrees).
4. Additional features of the Gratloch™ Wire Bender are two angled cannulations at the proximal end of each handle for flush bending of wire (0.045" and 0.062").

KMedic® Gratloch™ Wire Bender Detail

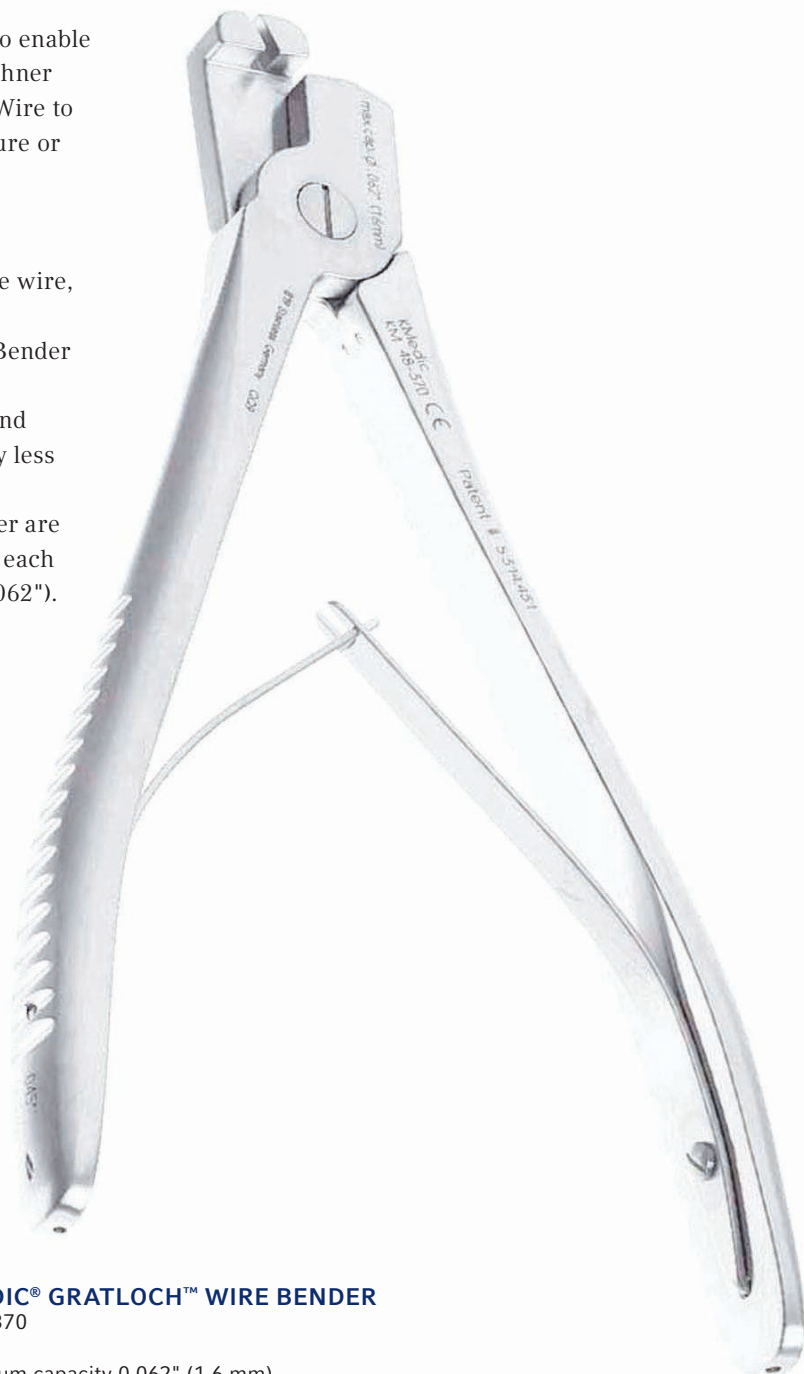
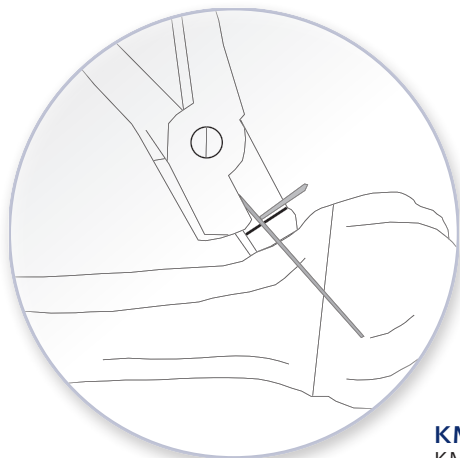

## KMEDIC® GRATLOCH™ WIRE BENDER

KM48370

7-1/2"

Maximum capacity 0.062" (1.6 mm)

Special hardened, wear-resistant

Stainless tool-grade stainless steel

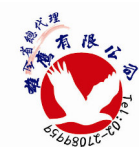

# KMEDIC® WIRE AND PIN IMPLANTS

## Wire and Pin Drivers and Benders

### P.I. BURIED K-WIRE SET



ITEM #	DESCRIPTION
	<p>KWire Set includes:                      KM46572 - 2 MM DOUBLE ACTION WIRE EXTRACTION PLIERS                      KM46573 - 4 MM DOUBLE ACTION WIRE EXTRACTION PLIERS                      KM46574 - 6 MM DOUBLE ACTION WIRE EXTRACTION PLIERS</p> <p>Recommended for heavy use. Double action and finely serrated carbide tips combine to provide a powerful grip on K-Wires and pins.</p> <ul style="list-style-type: none"> <li>• 2 mm tip is ideal for removing K-Wire up to 0.62 mm from small, hard-to-reach sites.</li> <li>• 4 mm and 6 mm jaws are ideal for grasping and pulling all sizes of K-Wires and pins.</li> <li>• 7-1/4" (18.5 cm).</li> </ul>
KM69905	<p>KM46631 - FLUSH WIRE CUTTER                      This improved version of our Front and Side Cutter cuts flush to the bone like no other wire cutter. This is a big advantage in buried wire procedures.</p> <p>Front and side cutting with carbide inserts, double action, maximum capacity 0.059" (1.5 mm), 6-3/4" (17 cm).</p>
	<p>KM48252 - PLUG CUTTER                      When removing K-Wire, use the Plug Cutter to extract a tiny cylinder of bone around the tip of the wire.</p> <p>3 mm I.D., 5 mm O.D., length with obturator 4-1/2" (11.5 cm).</p>

### WIRE AND PIN BENDER



Aids in bending pins and wires.

ITEM #	DESCRIPTION
KM48372	Accepts wires and pins up to 1/8" (3.2 mm), overall length 5-7/8" (15 cm)





# WIRE TWISTERS AND WIRE/PIN/ROD CUTTERS

Wire and Pin Drivers and Benders

## CROWN FIXATOR



KM49910

Helpful for fixating a fracture particle with K-Wire.  
Cannulation accepts wires up to 2.0 mm.

ITEM #	DESCRIPTION
KM49910	Cannulated, 6-1/2" (6.5 cm)





# WIRE TWISTERS AND WIRE/PIN/ROD CUTTERS

## Wire Twisters

### LOUTIE WIRE TIGHTENER

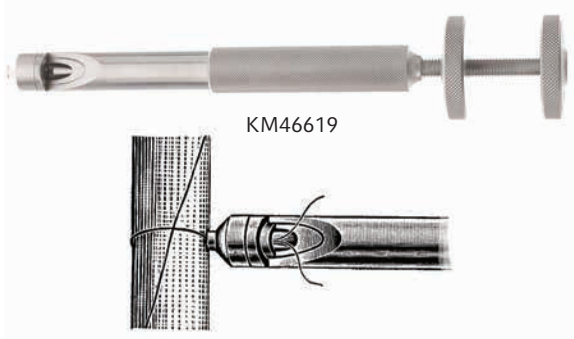

ITEM #	DESCRIPTION
KM46619	Maximum capacity 1.5 mm or 17 gauge cerclage wire, 8-1/2" (21.5 cm)

### WIRE TWISTING FORCEPS

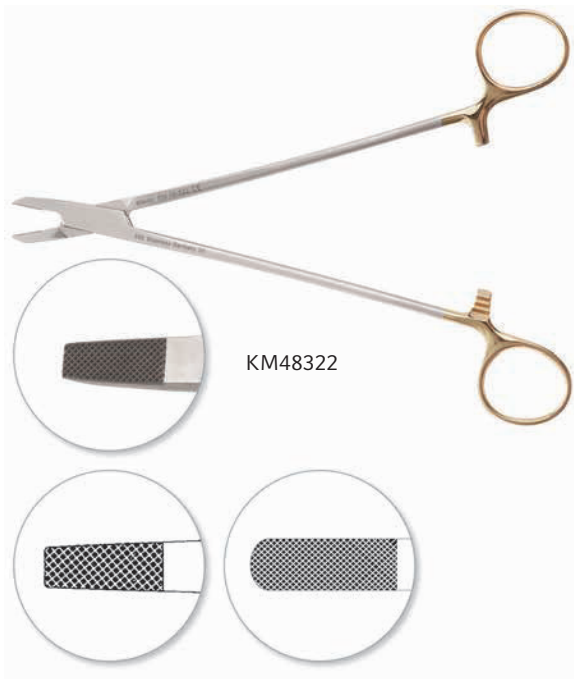

Carbide inserts.

ITEM #	DESCRIPTION
KM48320	6" (15 cm), TC
KM48322	4 mm tip, 8" (21 cm), TC
KM48324	6 mm tip, 7-1/4" (19 cm), TC

KM48320

KM48324







# WIRE TWISTERS AND WIRE/PIN/ROD CUTTERS

## Wire Twisters

### WIRE PULLING FORCEPS



Facilitates holding and pulling of pins and wires.

ITEM #	DESCRIPTION
KM46637	Maximum capacity 1 mm, 6-1/2" (17 cm)



# KMEDIC® CORWIN WIRE TWISTER

## HOW TO USE THE KMEDIC® CORWIN WIRE TWISTER:

1. Wrap wire around bone and position ends next to each other.
2. Grasp both ends of wire with jaws.
3. Engage the ratchet to enforce solid clamping.
4. Stabilize wiring site.
5. Pull back on center ring repeatedly until wire has reached desired tension.
6. Disengage ratchet.

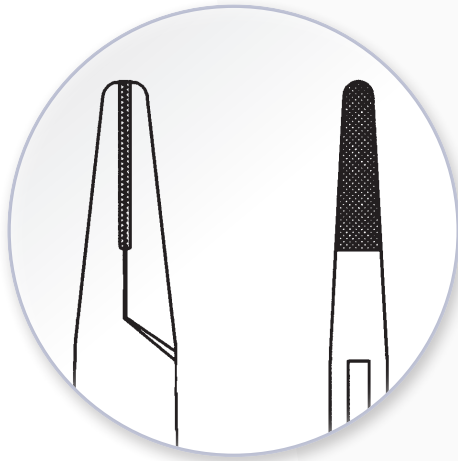

### KMEDIC® CORWIN WIRE TWISTER

KM46582

6-1/4" (16 cm) with carbide inserts

Maximum capacity 0.8 mm or 21 gauge cerclage wire



Saves time by semi-automatically twisting soft wire.



# KMEDIC® P.I. WIRE TWISTER AND TIGHTENER



**KMEDIC® P.I. WIRE TWISTER AND TIGHTENER**  
KM69846  
6-1/4" (16 cm)

## FOLLOW THESE EASY STEPS TO TWIST AND TIGHTEN CERCLAGE WIRE:

1. Position wire around bone. Bend the ends of the wire slightly upwards.
2. Feed both twisted wire ends through the tongue and groove jaw and push out and up through the jaw fenestration.
3. Engage the ratchet. This will lock the wire in place. Turn the entire instrument, tightening the wire around the bone.

*For more information please refer to the Instruction For Use.*



# KMEDIC® JET WIRE TWISTER

The KMedic® Jet Wire Twister is designed to provide fast, smooth and even twisting of soft wire, saving time in the OR. Suitable for the entire range of cerclage wire.

## HOW TO USE THE KMEDIC® JET WIRE TWISTER:

1. Wrap wire around bone and position ends next to each other.
2. Grasp both ends of wire with jaw.
3. Engage the ratchet to enforce solid clamping.
4. Stabilize wiring site.
5. Pull back on t-handle repeatedly until wire has reached desired tension.
6. Disengage ratchet.

Note: Jaws can be customized. Please contact us for details.

*For more information please refer to the Instruction For Use.*



**KMEDIC® JET WIRE TWISTER**  
KM49810  
11" (28 cm)  
10 mm tip

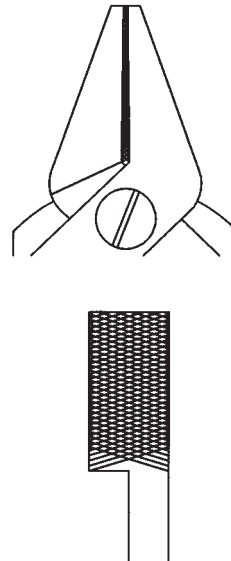



# ABOUT KMEDIC® WIRE AND PIN CUTTERS

Teleflex® can meet all of your wire and pin cutting requirements with our complete line of KMedic® Stainless Steel Cutting Instruments.

## MADE FROM STAINLESS STEEL

All of our wire cutters are engineered to meet the demanding needs of cutting rods, pins, cables and wires in the Operating Room. Jaws are made from the toughest specially-tempered tool steel or have tungsten carbide inserts.

## MORE CUTTING POWER

Cutters designed with double action give you more cutting power and help absorb the shock of wire cutting. There is better control and less fatigue for the surgeon.

## MOST EXTENSIVE SELECTION

We offer more jaw and handle styles than any other instrument company.

## NOTE ON CARBIDE INSTRUMENTS

Instruments with carbide inserts can be replaced, however, welded carbide jaws cannot be replaced.

## TO ACHIEVE THE BEST RESULTS WHEN CUTTING WIRES AND PINS, FOLLOW THESE SIMPLE STEPS:

- Choose the appropriate cutter for the wire diameter you want to cut
- Do not exceed the maximum capacity marked on each cutter
- Cut wire in the middle of the jaw—not on the tip or in the corner
- Keep the jaw at right angles to the piece being cut. Do not twist or turn cutter

## IMPORTANT NOTE ON MAXIMUM CAPACITIES

All maximum capacities noted in this catalog are based on tests using standard strength implant material. Cutting material which exceeds our recommended maximum capacities may damage or shorten the life of cutting edges and voids the instrument warranty. Please check the size of the material and the maximum capacity of the instrument before using.

*For more information, please refer to the Instructions For Use.*





# WIRE TWISTERS AND WIRE/PIN/ROD CUTTERS

## Wire Cutters

### DELICATE WIRE CUTTER



KM46622

Delicate side-cutting jaws with carbide inserts. Especially useful for pediatric, foot and hand surgery.

ITEM #	DESCRIPTION
KM46622	Side cutting with carbide inserts, maximum capacity 0.028" (0.7 mm), 4-7/8" (12.5 cm)

### PILLING® STAINLESS STEEL WIRE CUTTING FORCEPS



142550

ITEM #	DESCRIPTION
142550	6-7/8" (17.5 cm)

### PILLING® WIRE CUTTERS



142519



142520

ITEM #	DESCRIPTION
142519	Single action, 7-7/8" (20 cm), TC
142520	Angled jaw, double action, 8-1/2" (21.5 cm), TC





# WIRE TWISTERS AND WIRE/PIN/ROD CUTTERS

## Wire Cutters

### SIDE CUTTER



KM46621

ITEM #	DESCRIPTION
KM46621	Side cutting, welded carbide jaws, maximum capacity 0.062" (1.6 mm), 7-1/4" (18.5 cm)

### KMEDIC® SIDE CUTTER



KM49736

Welded carbide jaws.

ITEM #	DESCRIPTION
KM49736	Maximum capacity 3/32" (2.4 mm), 9" (23 cm)

### K-WIRE SIDE CUTTER



KM49734

Welded hardened jaws.

ITEM #	DESCRIPTION
KM49734	Maximum capacity 0.045" (1.1 mm), 6" (15 cm)

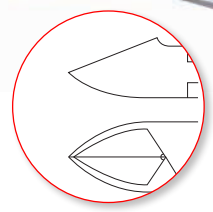

# WIRE TWISTERS AND WIRE/PIN/ROD CUTTERS

## Wire Cutters

### KMEDIC® WIRE CUTTER WITH SAFETY INSERTS

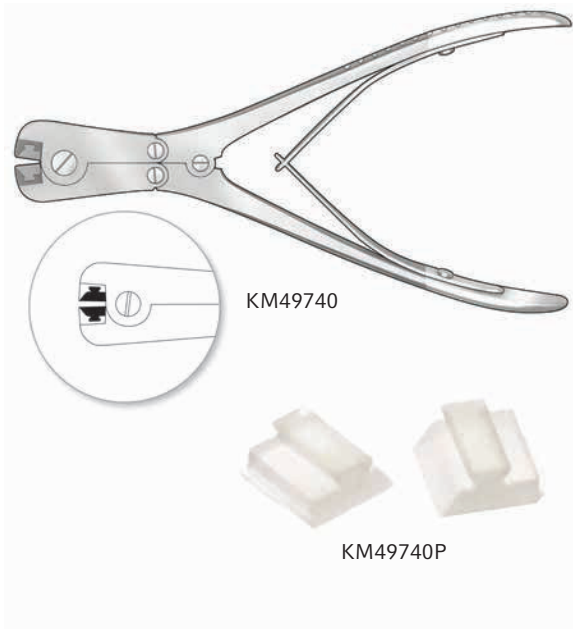

Combines maximum leverage and optimum safety. The KMedic® Wire Cutter with Safety Inserts can help prevent the potentially dangerous occurrence of flying K-Wire pieces in the OR. This instrument is designed to hold the cut piece of wire in its silicon inserts. After cutting, the remnant wire can be safely disposed of, thus preventing cut pieces from falling into the wound site or flying into the air. The silicon inserts are autoclavable and long-lasting. And as inserts are not glued into the jaws, replacement is fast and easy. Simply insert the new ones by pressing them into place. Inserts do not fall out or move under normal circumstances. Front and side cutting, double action.

ITEM #	DESCRIPTION
KM49740	Maximum capacity 0.062" (1.6 mm), 6-7/8" (17.5 cm)
KM49740P	Set of replacement silicon inserts

### DOUBLE ACTION WIRE CUTTERS



KM46623

Narrow jaw makes this cutter a favorite with hand and foot surgeons.

ITEM #	DESCRIPTION
KM46623	Angled, side cutting with carbide inserts, maximum capacity 0.062" (1.6 mm), 6-5/8" (17 cm)
KM46624	Angled, side cutting with carbide inserts, maximum capacity 3/32" (2.4 mm), 8-1/2" (21.5 cm)







# WIRE TWISTERS AND WIRE/PIN/ROD CUTTERS

## Wire Cutters

### FRONT AND SIDE WIRE CUTTER



KM46625

ITEM #	DESCRIPTION
KM46625	Front and side cutting with carbide inserts, double action, maximum capacity 0.062" (1.6 mm), 6-3/4" (17 cm)

### FLUSH WIRE CUTTER



KM46631

This improved version of our Front and Side Cutter cuts flush to the bone like no other wire cutter. This is a big advantage in buried wire procedures.

ITEM #	DESCRIPTION
KM46631	Front and side cutting with carbide inserts, double action, maximum capacity 0.059" (1.5 mm), 6-3/4" (17 cm)

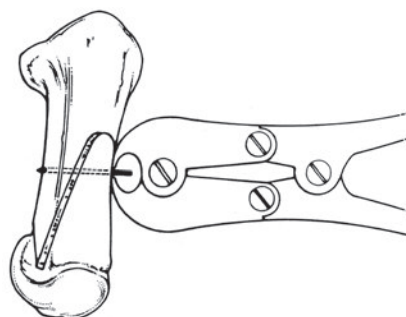



# WIRE TWISTERS AND WIRE/PIN/ROD CUTTERS

## Wire Cutters

### K-WIRE END CUTTER



KM49735

ITEM #	DESCRIPTION
KM49735	Maximum capacity 0.045" (1.1 mm), 5-1/2" (14 cm)

### KMEDIC® END CUTTER



KM49738

Welded carbide jaws.

ITEM #	DESCRIPTION
KM49738	Maximum capacity 3/32" (2.4 mm), 8-1/2" (21.5 cm)

## Pin Cutters

### CANNULATED PIN CUTTER



KM46647

Cannulation allows you to slide the cutter over the inserted wire. The piece cut off will be held safely inside the channel.

ITEM #	DESCRIPTION
KM46647	End cutting, maximum capacity 0.062 (1.6 mm), 7-1/4" (18.5 cm)





# WIRE TWISTERS AND WIRE/PIN/ROD CUTTERS

## Pin Cutters

### DIAMOND PIN CUTTER



Disassembles easily for cleaning.

ITEM #	DESCRIPTION
KM46651	End cutting, maximum capacity 5/64" (2 mm), 6-3/8" (16 cm)

### END CUTTER



ITEM #	DESCRIPTION
KM46649	End cutting, welded carbide jaws, maximum capacity 0.062" (1.6 mm), 5-3/4" (14.5 cm)

### DOUBLE ACTION PIN CUTTER



Double action handles give more power to cut pins up to 1/8" (3.2 mm). Side cutting.

ITEM #	DESCRIPTION
KM49800	Maximum capacity 1/8" (3.2 mm), 9-1/2" (24 cm)



# WIRE TWISTERS AND WIRE/PIN/ROD CUTTERS

## Pin Cutters

### SIDE PIN CUTTER



KM46629

Heavy duty cutter for rods up to 4 mm and heavy Steinmann pins. Slightly angled jaws house long-lasting special carbide inserts for cutting hard titanium and stainless steel rods.

ITEM #	DESCRIPTION
KM46629	Side cutting with carbide inserts. Maximum capacity 5/32" (4 mm), 15" (38 cm)

### SMALL PIN CUTTER



KM46632

ITEM #	DESCRIPTION
KM46632	Maximum capacity 1/8" (3.2 mm), 10-1/4" (26 cm)

### MEDIUM PIN CUTTER

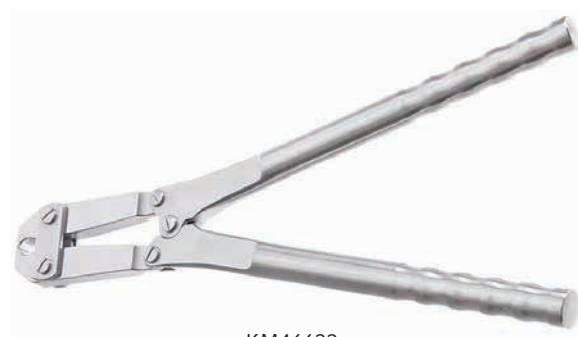

KM46633

Heavy duty cutters with replaceable jaws.

ITEM #	DESCRIPTION
KM46633	Maximum capacity 3/16" (4.7 mm), 14-3/8" (36.5 cm)







# KMEDIC® LARGE PIN CUTTER

Only available from Teleflex®

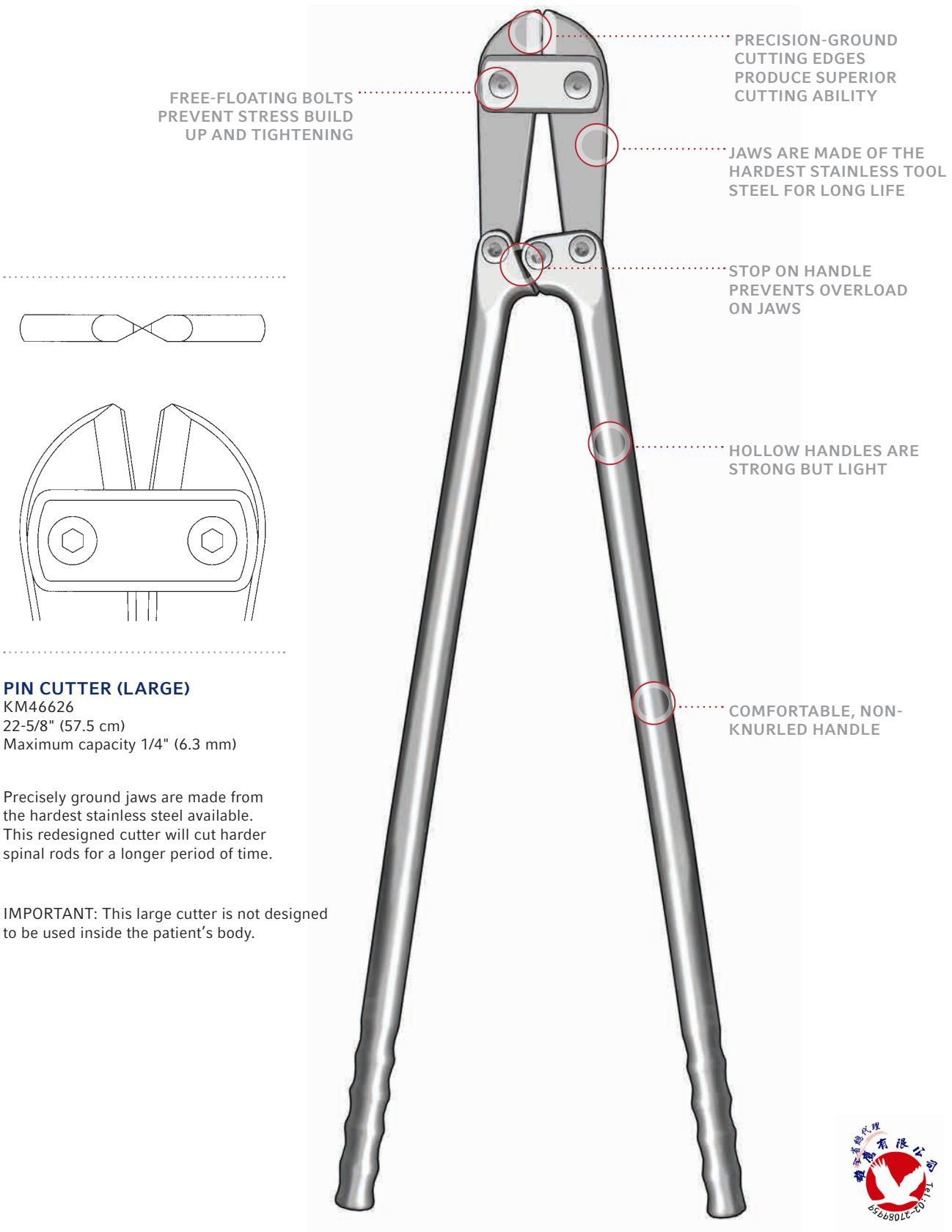

FREE-FLOATING BOLTS  
PREVENT STRESS BUILD  
UP AND TIGHTENING

PRECISION-GROUND  
CUTTING EDGES  
PRODUCE SUPERIOR  
CUTTING ABILITY

JAWS ARE MADE OF THE  
HARDEST STAINLESS TOOL  
STEEL FOR LONG LIFE

STOP ON HANDLE  
PREVENTS OVERLOAD  
ON JAWS

HOLLOW HANDLES ARE  
STRONG BUT LIGHT

COMFORTABLE, NON-  
KNURLED HANDLE

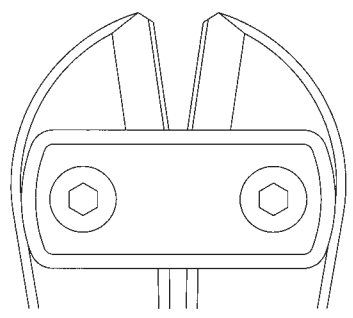
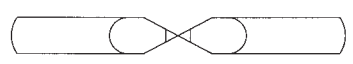

## PIN CUTTER (LARGE)

KM46626  
22-5/8" (57.5 cm)  
Maximum capacity 1/4" (6.3 mm)

Precisely ground jaws are made from the hardest stainless steel available. This redesigned cutter will cut harder spinal rods for a longer period of time.

**IMPORTANT:** This large cutter is not designed to be used inside the patient's body.



# WIRE TWISTERS AND WIRE/PIN/ROD CUTTERS

## Pin Cutters

### PLATE CUTTING FORCEPS



KM47932

For cutting stainless steel mini plates up to 1 mm.

ITEM #	DESCRIPTION
KM47932	Straight, 9-1/4" (24 cm)





# KMEDIC® CABLE CUTTER

Cuts cleanly through cables without fraying

DURABLE TUNGSTEN CARBIDE JAWS CUT HARD CABLES SMOOTHLY AND EASILY

STRONG JOINT DESIGN IS LONG-LASTING AND ALLOWS PRECISE CUTTING

HANDLE STOP FOR DEFINED JAW TRAVEL

JAW ANGLE CAPTURES THE CABLE, THEN CUTS THROUGH ALL STRANDS AT ONCE—ELIMINATING FRAYED ENDS

CUTS THROUGH CABLE WITH ONE CUT—REDUCING RISK OF SMALL CABLE PARTICLES FALLING INTO OPERATING SITE

**CABLE CUTTER**  
 KM48378  
 7" (18 cm)  
 Maximum capacity 2.0 mm  
 Cable jaws can be resharpened and replaced.

NOTE: This instrument should only be used for cutting cable. Lubricate joint to ensure proper function.

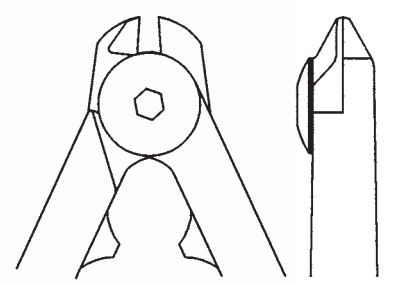

Small jaw design enables surgeon to get close to bone – even in tight spaces.

POSITIVE HANDLE BARS PROVIDE COMFORTABLE NON-SLIP GRIP AND PRECISE CONTROL

LONG-LASTING EXTRA-HEAVY SPRINGS PROVIDE SOLID RETURN



# WIRE TWISTERS AND WIRE/PIN/ROD CUTTERS

## Rod Cutters

### HAND-HELD ROD CUTTER

All of the benefits of the table top cutter in a hand-held model. Cuts rods from 4.76 mm 3/16" to 6.35 mm (1/4"). **IMPORTANT:** This large cutter is not designed to be used inside the patient's body.

ITEM #	DESCRIPTION
KM46635	Stainless steel with silicone handle, 27" (68.5 cm)



KM46635



# TABLE TOP ROD CUTTER

Provides an easy and safe way to cut spinal rods.



## KMEDIC® TABLE TOP ROD CUTTER

KM46628

27-1/2" (70 cm)

Cuts rods from 4.76 mm (3/16") to 6.35 mm (1/4")

Powerful double-action jaws enable surgeons to cut 1/4" rods with one hand. Shearing action cuts cleanly no raised burrs or sharp jagged edges. Unique cutting process can help prevent the potentially dangerous occurrence of flying rod pieces in the OR.

Ergonomically-designed Ortho-Grip™ Silicone Handle provides a comfortable, slip-proof grip. Base and handle are perfectly balanced to ensure stability and prevent lifting. Simple, efficient design has no folding levers, loose parts or bearings that can breakdown. Cuts rods from 4.76 mm (3/16") to 6.35 mm (1/4").

### HOW TO USE THE KMEDIC® TABLE TOP ROD CUTTER:

1. Lift handle up.
2. Insert rod in proper diameter hole.
3. Press handle down.

*Ortho-Grip is a trademark or registered trademark of Teleflex® Incorporated or its affiliates.*

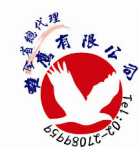



# PLIERS

Pliers

## NARROW NOSE WIRE PULLING FORCEPS



Extra heavy jaws for pulling K-Wires and Steinmann Pins. An economical alternative to double action pliers. Jaw tapers to 3 mm.

ITEM #	DESCRIPTION
KM48253	3 mm tip, 7-1/2" (19 cm)

## NEEDLE NOSE PLIERS

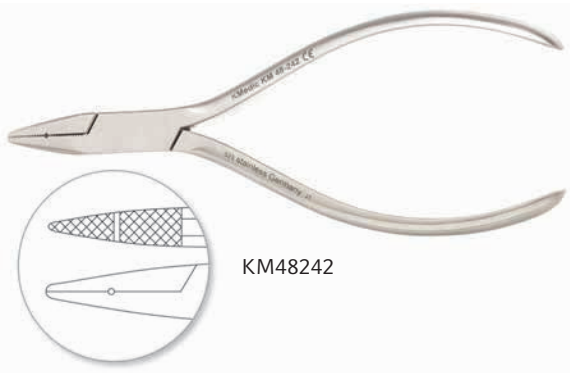

Delicate needle nose jaws specifically designed to handle cerclage wire. Jaw tapers to 1 mm.

ITEM #	DESCRIPTION
KM48242	Delicate, 5-3/8" (13.5 cm)



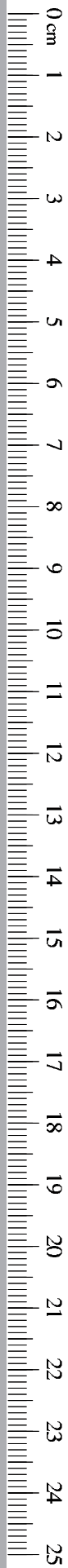

# PLIERS

## Pliers

### NEEDLE NOSE PLIERS



KM48245

Jaw tapers to 2 mm, making it easier to get close to the bone to remove K-Wires.

ITEM #	DESCRIPTION
KM48245	5-3/8" (13.5 cm)

### LONG JAW NEEDLE NOSE PLIERS



KM48250

Long delicate jaws are 2 mm at the tip. Perfect for pulling K-Wires, especially in hard-to-reach sites.

ITEM #	DESCRIPTION
KM48250	Parallel grooved 2" (50 mm) long jaws, 1.5 mm tip, 7" (18 cm)





# PLIERS

## Pliers

### FLAT NOSE PLIERS



Delicate jaws taper to 2 mm. Made to twist and bend cerclage wire.

ITEM #	DESCRIPTION
KM48248	Delicate, 2 mm tip, 6" (15 cm)

### FLAT NOSE PLIERS



Combination plier and cutter. Cuts all sizes (0.2 mm to 1.5 mm) of cerclage wire. Jaws taper to 3.5 mm.

ITEM #	DESCRIPTION
KM48243	6-1/2" (16.5 cm)





# PLIERS

## Pliers

### FLAT NOSE PLIERS



For wire manipulation.

ITEM #	DESCRIPTION
KM48246	Broad, 4 mm tip, 5-3/8" (13.5 cm)

### PIN PULLING PLIERS



Tungsten carbide inserts and grooved opposing jaw design grips small pins securely. Small size is well suited for hand procedures. Jaws are 3 mm at tip.

ITEM #	DESCRIPTION
KM46578	5-1/2" (14 cm), TC

### SCREW REMOVAL FORCEPS



Useful for removing 3.0 mm to 4.5 mm screws.

ITEM #	DESCRIPTION
KM49920	7" (18 cm), with speed lock, TC



# PLIERS

Pliers

## K-WIRE EXTRACTION PLIERS



KM48257

With screw lock.

ITEM #	DESCRIPTION
KM48257	3 mm tip, 5" (13 cm)
KM48258	4 mm tip, 7" (18 cm)

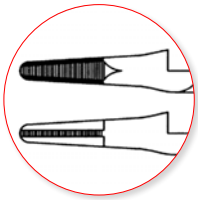

KM48257

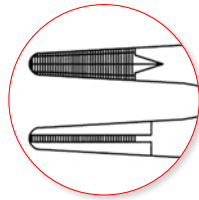

KM48258

## WIRE BENDING PLIERS



KM48269

ITEM #	DESCRIPTION
KM48269	5-7/8" (15 cm)







# PLIERS

## Pliers

### SLIP JOINT PLIERS



KM48262

Traditional design utility pliers with adjustable jaws. Good all-purpose plier for handling Steinmann Pins, K-Wires, screws and rods. 10 mm jaw tip.

ITEM #	DESCRIPTION
KM48262	Maximum opening 2" (5 cm), 8" (20.5 cm)

### FLAT NOSE K-WIRE PLIERS

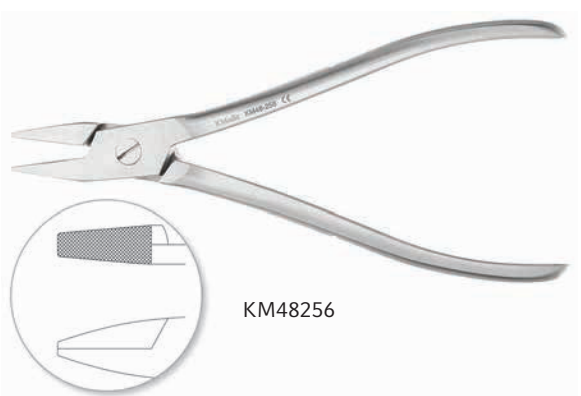

KM48256

Multi-purpose plier with flat jaws that taper to 6 mm for pulling K-Wire.

ITEM #	DESCRIPTION
KM48254	6 mm tip, with side groove for cerclage wire, 6-3/4" (17 cm)
KM48256	6 mm tip, 6-3/4" (17 cm)

### LINEMAN PLIERS



KM48259

Combination pliers and K-Wire Cutter. An economical general purpose instrument with cutting edge.

ITEM #	DESCRIPTION
KM48259	Side cutting, maximum capacity .062" (1.6 mm), 8-1/2" (21.5 cm)





# PLIERS

## Pliers

### DOUBLE ACTION WIRE EXTRACTION PLIERS



- Recommended for heavy use. Double action and finely serrated carbide tips combine to provide a powerful grip on K-Wires and pins.
- 2 mm tip is ideal for removing K-Wire up to 0.62 mm from small, hard-to-reach sites.
- 4 mm and 6 mm jaws are ideal for grasping and pulling all sizes of K-Wires and pins.
- 7-1/4" (18.5 cm).

ITEM #	DESCRIPTION
KM46572	2 mm delicate jaw, TC
KM46573	4 mm jaw, TC
KM46574	6 mm jaw, TC

### PARALLEL PLIERS



Parallel grooved 10 mm jaws provide enormous gripping power. Ideal for pin removal.

ITEM #	DESCRIPTION
KM48604	Maximum opening 1/2", 7-1/4" (18.5 cm)





# PLIERS

## Pliers

### PARALLEL PLIERS WITH CUTTER

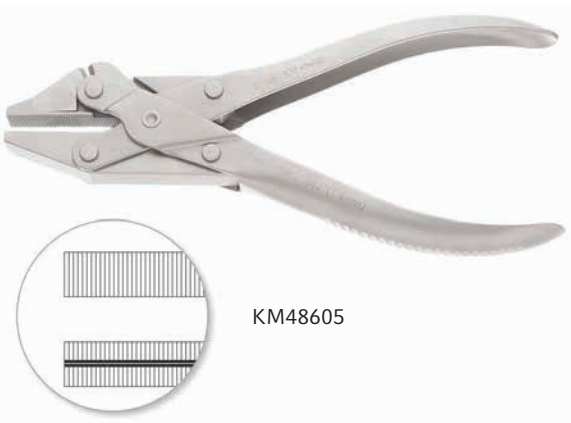

Combination pliers and wire cutter has all the benefits of our Parallel Pliers plus a cutting jaw for K-Wires up to 0.062" (1.6 mm).

ITEM #	DESCRIPTION
KM48605	Maximum capacity .062" (1.6 mm), 7" (18 cm)



# PLIERS

## Locking Pliers

### HEAVY DUTY LOCKING PLIERS

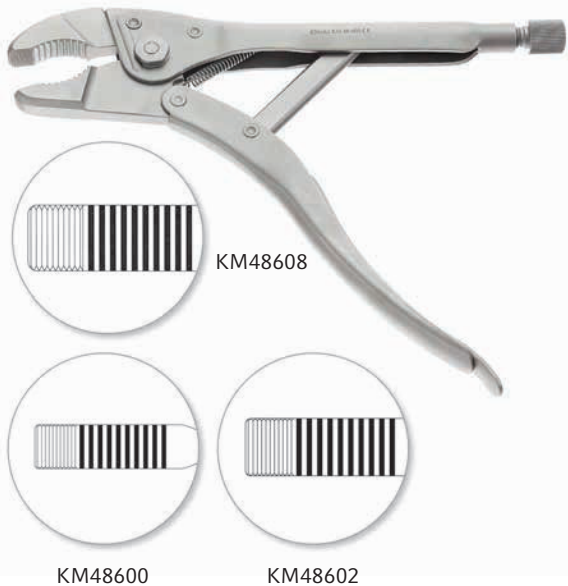

With a new, reinforced, more durable jaw.

- Heavy duty jaws lock securely onto pins.
- Reinforced jaw hinge and housing are more rigid to help prevent side to side shifting.
- Made from 300 and 400 series surgical grade stainless steel.
- Will not chip or contaminate other instrumentation.
- Adjustment screw for easy control of jaw opening.
- One-handed, quick release self-locking lever.
- Available in three sizes.

ITEM #	DESCRIPTION
KM48600	Small, 7 mm wide tip, maximum opening 1" (25 mm), 6-3/4" (17 cm)
KM48602	Medium, 9 mm wide tip, maximum opening 1" (25 mm), 8" (20.5 cm)
KM48608	Large, 13 mm wide tip, maximum opening 1-1/2" (38 mm), 10" (25.5 cm)

### NEEDLE NOSE LOCKING PLIERS



With a new reinforced, more durable jaw.

- New 12" model has an impressive, powerful jaw. The body is made from 2.5 mm stainless steel. This plier will hold up better in the OR than any other needle nose plier - we guarantee it!
- Both pliers have a more durable, reinforced jaw hinge and housing which helps keep the ends in alignment, especially when the plier is twisted.
- Other features: one tapered "V" grooved jaw which locks securely onto pins; adjustment screw; and one handed, quick release self-locking lever.
- KMedic® Pliers are made from 300 and 400 series surgical grade stainless steel. Unlike "hardware store" quality, they will not chip or contaminate other instrumentation.

ITEM #	DESCRIPTION
KM48606	9-1/2" (24 cm)
KM48610	Large, 12" (30.5 cm)

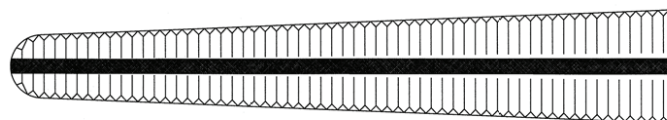

KM48610





# PLIERS

## Locking Pliers

### LOCKING PLIERS WITH SLAPHAMMERS



KM48616



KM48620

A powerful combination of locked gripping strength and controlled hammer action.

- These stainless steel heavy duty locking pliers with slaphammers enable surgeons to more easily extract prostheses, intramedullary nails and hip fracture plates.
- The large pliers offer maximum versatility - slaphammers can be attached in three places; on the end or on either side. Small and medium pliers have end attachments only.
- If additional force is required, a mallet may be used on the hammer plate.

ITEM #	DESCRIPTION
KM48614	Medium, end attachment only, 8" (20.5 cm)
KM48616	Large, end and side attachments, 10" (25.5 cm)
KM48620	Needle Nose Locking Pliers, medium, end attachment only, 9-1/2" (24 cm)
KM48622	Needle Nose Locking Pliers, large, end and side attachments, 12" (30.5 cm)

## Plate Bending Pliers

### MINI PLATE BENDING PLIERS

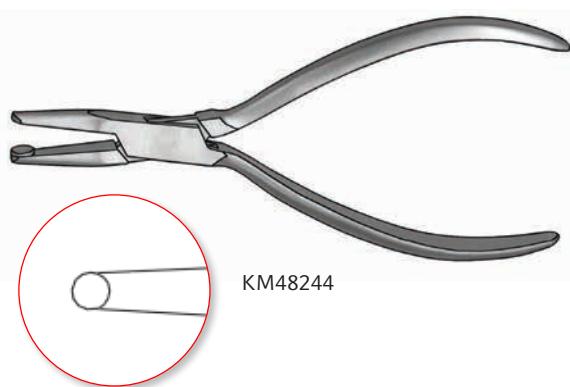

KM48244

For 1.5 mm and 2.0 mm plates.

ITEM #	DESCRIPTION
KM48244	5-1/8" (13 cm)







# PLIERS

## Plate Bending Pliers

### BENDING PLIERS

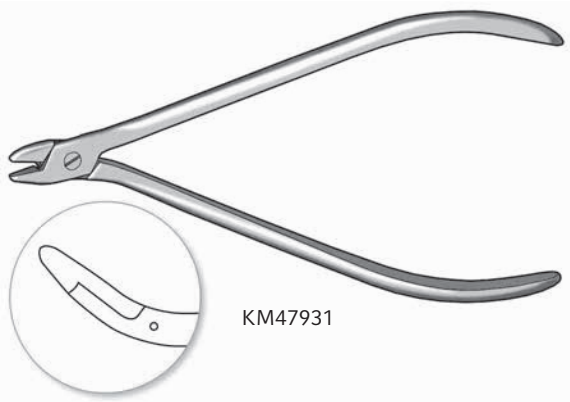

KM47931

For 1.5 mm and 2.0 mm plates.

ITEM #	DESCRIPTION
KM47931	5-3/4" (14.5 cm)

### PLATE BENDING PLIERS



KM47927

For reconstruction plates.

ITEM #	DESCRIPTION
KM47927	9-3/8" (23.5 cm)

### PLATE BENDING PLIERS



KM47928

Includes two anvils for narrow and broad plates.

ITEM #	DESCRIPTION
KM47928	10" (26 cm)





# PLIERS

## Plate Bending Pliers

### SMALL PLATE BENDING PLIERS



KM47925

For 2.7 mm and 3.5 mm plates.

ITEM #	DESCRIPTION
KM47925	7-5/8" (19.5 cm)

### PLATE BENDING PRESS



KM47929

ITEM #	DESCRIPTION
KM47929	13-3/4" (35 cm)





# PLIERS

## Socket Wrenches

### COMBINATION WRENCH

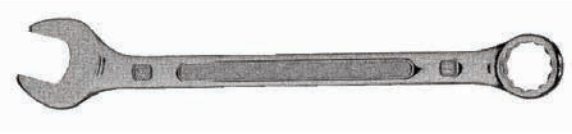

KM45412

ITEM #	DESCRIPTION
KM45412	11 mm, 5-1/2" (14 cm)

### SOCKET WRENCH



KM47912

ITEM #	DESCRIPTION
KM45410	11 mm, 7-3/4" (20 cm)
KM47912	Chrome vanadium, 11 mm, 6-3/4" (17 cm)

### WRENCH



KM47914

For tightening 8 mm nuts.

ITEM #	DESCRIPTION
KM47914	5-7/8" (15 cm)





# WIRE GUIDES AND TRACTION BOWS

## DEMEL WIRE GUIDES



KM48382

ITEM #	DESCRIPTION
KM48380	30 mm diameter, 10-1/2" (26.5 cm)
KM48382	47 mm diameter, 11-1/2" (29 cm)
KM48384	57 mm diameter, 12-1/2" (32 cm)

## WIRE AND PIN TRACTOR (BOEHLER)



KM48328

Each Wire and Pin Tractor comes with one single trocar round end Steinmann Pin as listed.

ITEM #	SIZE	INSIDE LENGTH	INSIDE WIDTH	PIN INCLUDED	PIN SIZE AND DIAMETER
KM48326	Small	90 mm	75 mm	KM71432	5" 2.4 mm
KM48328	Medium	160 mm	90 mm	KM71434	7" 3.2 mm
KM48330	Large	210 mm	150 mm	KM71525	9" 4.0 mm

## KIRSCHNER BOWS

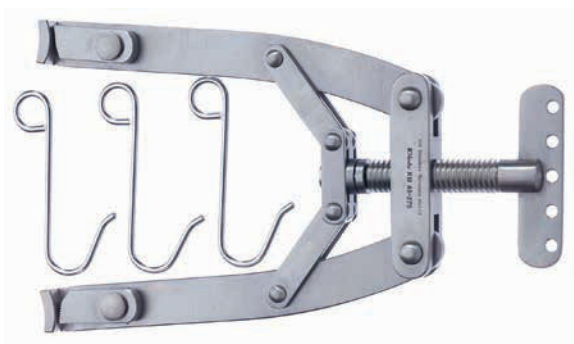

KM48270

Each Kirschner Bow comes with three hooks.

ITEM #	DESCRIPTION
KM48270	Small, 5-3/4" (14.5 cm)
KM48272	Large, 7-1/2" (19 cm)
KM48274	Extra large, 9-5/8" (24.5 cm)





# LIGATURE CARRIERS AND WIRE PASSERS

## WIRE PASSERS (CANNULATED)



Cannulation allows for easy feeding of wire around the bone.

ITEM #	DESCRIPTION
KM48386	45 mm diameter, 7" (18 cm)
KM48388	70 mm diameter, 9-1/2" (24 cm)

## SUTURE PASSERS



Used to pass sutures in shoulder surgery. Curved, 9-1/4" (23.5 cm).

ITEM #	DESCRIPTION
KM46917	With crochet hook*
KM46918	With suture hole

*Autoclavable to 290°F (143°C)*







# DRILLS, DRILL BITS AND GUIDES

## Drills — Hand Drills

### BUNNELL DRILL



Accepts wires and pins up to 4.0 mm (5/32"). Store chuck key in handle. Body is made of aluminum.

ITEM #	DESCRIPTION
KM48392	Cannulated, 3-jaw stainless Jacobs chuck, includes key chuck, 5-3/4" (14.5 cm)
KM48392P	Key only, stored in drill handle

### MARTIN DRILL

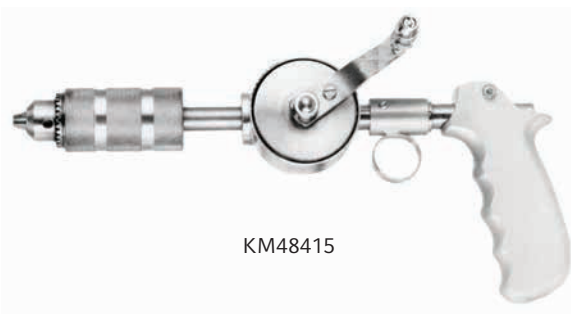

Stainless drill, anodized aluminum handle.

ITEM #	DESCRIPTION
KM48415	10-1/2" (26.5 cm)

### MOORE DRILL AND BIT SET



Drill is chrome plated with stainless handle.

ITEM #	DESCRIPTION
KM48423	Moore Drill and complete set of stainless drill bits
KM48420	Drill only, 11" (28 cm)
KM48421	Drill bit, 70 mm length, 3.2 mm diameter
KM48422	Drill bit, 90 mm length, 3.2 mm diameter



# DRILLS, DRILL BITS AND GUIDES

## Drills — Hand Drills

### RALKS DRILL



Includes key chuck. Accepts wires and pins up to 6.35 mm (1/4"). Offset handle. Body is made of aluminum.

ITEM #	DESCRIPTION
KM48390	Cannulated, 3-jaw stainless chuck, 5-3/4" (14.5 cm)
KM48390P	Key only

### STILLE PATTERN DRILL, BITS AND BURRS



ITEM #	DESCRIPTION
KM48438	Drill and complete set of stainless drill bits and burrs
KM48425	Drill only, with quick coupling, chrome plated, stainless handle, 8" (20.5 cm)
KM48426	Drill bit, 2.5 mm
KM48427	Drill bit, 3.0 mm
KM48428	Drill bit, 3.5 mm
KM48429	Drill bit, 4.0 mm
KM48431	Round burr, 5 mm
KM48433	Round burr, 12 mm
KM48434	Round burr, 16 mm
KM48435	Drill bit, 1.0 mm
KM48436	Drill bit, 1.5 mm





# DRILLS, DRILL BITS AND GUIDES

## Drills — Hand Drills

### STILLE-SHERMAN DRILL



KM48465



KM48466

KM48467

KM48468

ITEM #	DESCRIPTION
KM48469	Drill and complete set of stainless drill bits and burrs
KM48465	Drill only, with quick coupling, chrome plated, stainless handle, 9-1/2" (24 cm)
KM48466	Drill bit, 2.5 mm
KM48467	Drill bit, 3.0 mm
KM48468	Drill bit, 3.5 mm

### UNIVERSAL DRILL



KM48394

This hand drill has a two-to-one gear ratio to ensure accurate drilling. The comfortable pistol grip offset handle gives the user perfect control. The chuck shaft and the entire length of the drill are cannulated. The cannulated shaft accepts Steinmann Pins, K-Wire, long shank drills and screw driver bits up to 4 mm (5/32").

ITEM #	DESCRIPTION
KM48394	Cannulated, stainless chuck, includes key chuck. Chuck accepts wires and pins up to 6.35 mm (1/4"). Body is made of aluminum, 10" (25.5 cm)



# DRILLS, DRILL BITS AND GUIDES

## Drills — Hand Drills

### KIRSCHNER DRILL SET



KM48450

ITEM #	DESCRIPTION
KM48450	Telescopic drill includes Drill Guide (KM48451), Coupling Bow (KM48442) and Chuck and Key (KM48443). Chrome plated gears, stainless handle. 15" (38 cm)
KM48451	Drill Guide
KM48442	Coupling Bow
KM48443	Chuck and Key



KM48451



KM48442



KM48443

### TELESCOPIC HAND DRILL SET



KM48440

ITEM #	DESCRIPTION
KM48440	Includes Drill Guide (KM48441), Coupling Bow (KM48442) and Chuck and Key (KM48443). Chrome plated gears, stainless handle. 12" (30.5 cm)
KM48441	Drill Guide (shown extended)
KM48442	Coupling Bow
KM48443	Chuck and Key



KM48441



KM48442



KM48443





# DRILLS, DRILL BITS AND GUIDES

## Drills — Hand Drills

### HUDSON DRILL AND BURRS

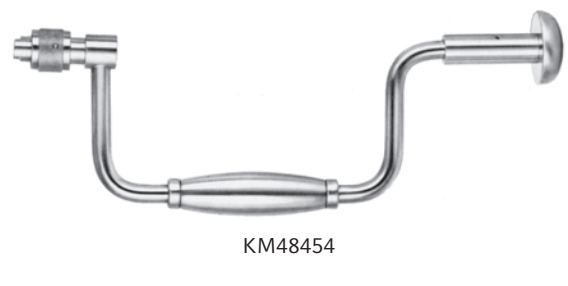

KM48454

Burrs sold separately.

ITEM #	DESCRIPTION
KM48454	Drill only, all stainless steel with improved snap-lock chuck, 10-1/2" (26.5 cm)
KM48456	Hudson Burr, 9 mm
KM48457	Hudson Burr, 14 mm
KM48458	Hudson Burr, 16 mm
KM48459	Hudson Burr, 22 mm
KM48455	Extension Piece, 3-7/8" (9.5 cm)



KM48456



KM48457



KM48458



KM48459



KM48455



# DRILLS, DRILL BITS AND GUIDES

## Drills — Hand Drills

### HUDSON DRILL BITS



KM48460



KM48461



KM48462



KM48463

For use with KM48454 Hudson Drill.

ITEM #	DESCRIPTION
KM48460	Cushing Drill bit, 14 mm
KM48461	Drill bit, 2 mm
KM48462	McKenzie Drill bit, 13 mm
KM48463	D'Errico Drill bit, 16 mm







# DRILLS, DRILL BITS AND GUIDES

## Drills — Quick Coupling Handles

### MINI QUICK COUPLING HANDLE



KM47902

For holding quick coupling drills, countersinks, taps and screwdrivers.

ITEM #	DESCRIPTION
KM47902	For mini screw set, 4-1/8" (10.5 cm)

### SMALL QUICK COUPLING T-HANDLE



KM47960

For holding quick coupling drills, countersinks, taps and screwdrivers.

ITEM #	DESCRIPTION
KM47960	For small and large screw sets, 3-1/2" (8.5 cm)

### SMALL QUICK COUPLING HANDLE



KM47904

For holding quick coupling drills, countersinks, taps and screwdrivers.

ITEM #	DESCRIPTION
KM47904	4-1/2" (11.5 cm)
KM47908	Rounded phenolic handle, 4-3/8" (11 cm) <i>Autoclavable to 290°F (143°C)</i>

## Drills — Adapters

### ADAPTER (POWER DRILL)



KM45002

ITEM #	DESCRIPTION
KM45002	2-1/2" (6.5 cm)



# KMEDIC® DRILL BIT STERILIZATION CASE

The KMedic® Drill Bit Sterilization Case provides easy access and can hold up to 19 5" (127 mm) Jacobs chuck\* drill bits for sterilization and storage.

- Reduce OR footprint: Lid folds back and holds the case upright
- Prevent drill bit damage: Tray lowers and holds drill bits in place when closing lid
- Prevent accidental opening: Top of case locks when closed
- Quick identification: Drill bit sizes and part numbers are clearly noted on the inside of case

## EASY TO CLEAN

- Innovative one-piece design eliminates the risk of losing drill bits
- Anodized aluminum case is lightweight, yet built to withstand abuse
- Fully autoclavable to 270°F/132°C

\* Also available in Quick Couple (QC) design.

## DRILL BIT STERILIZATION CASE

KM48100

Drill Bit Sterilization Case - 5" (127 mm)

Holds 2 each of the 5" Jacob's chuck drill bits (1 each of size 6.0 mm):

5.5 x 4.25 x 1.75" (140 mm x 108 mm x 45 mm)



KM48100

## 5" JACOB'S CHUCK DRILL BITS

ITEM #	DESCRIPTION	FLUTE LENGTH
KM48-129	1.0 mm x 127 mm	22.0 mm
KM48-130	1.5 mm x 127 mm	22.0 mm
KM48-132	2.0 mm x 127 mm	23.0 mm
KM48-134	2.4 mm x 127 mm	22.0 mm
KM48-136	2.7 mm x 127 mm	30.0 mm
KM48-137	3.2 mm x 127 mm	42.0 mm
KM48-138	3.5 mm x 127 mm	42.0 mm
KM48-140	4.0 mm x 127 mm	35.0 mm
KM48-142	4.7 mm x 127 mm	34.0 mm
KM48-143	6.0 mm x 127 mm	37.0 mm

## DRILL BIT CASE SET (FULLY LOADED)

KM48144

QUANTITY	INCLUDES	QUANTITY	INCLUDES
2	1.0 mm Drill Bit	2	3.2 mm Drill Bit
2	1.5 mm Drill Bit	2	3.5 mm Drill Bit
2	2.0 mm Drill Bit	2	4.0 mm Drill Bit
2	2.4 mm Drill Bit	2	4.7 mm Drill Bit
2	2.7 mm Drill Bit	1	6.0 mm Drill Bit



KM48137

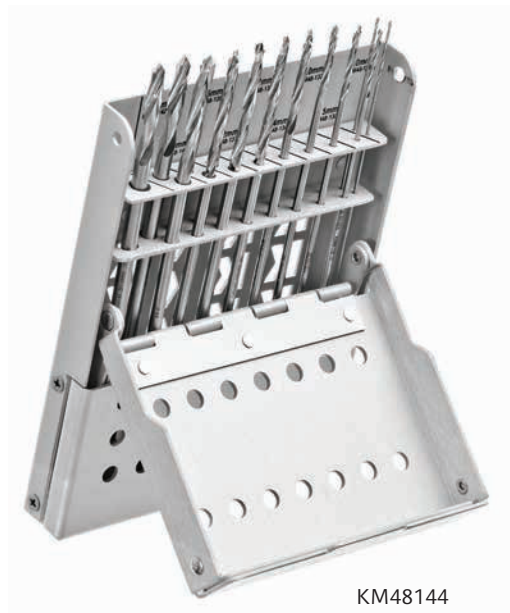

KM48144





# DRILLS, DRILL BITS AND GUIDES

## Drill Bits — Jacobs Chuck End

### DRILL BITS



KM48079

With round drill chuck end. Designed to fit any Jacobs chuck drill.

ITEM #	DIAMETER	FLUTE LENGTH	OVERALL LENGTH
KM48070	1.0 mm	25 mm	2-1/8" (5.5 cm)
KM48072	1.1 mm	11 mm	1-3/4" (4.5 cm)
KM48071	1.5 mm	30 mm	2-3/4" (7 cm)
KM48073	2.0 mm	38 mm	3-3/8" (8.5 cm)
KM48076	2.5 mm	43 mm	3-3/4" (9.5 cm)
KM48077	2.7 mm	32 mm	3-3/8" (8.5 cm)
KM48080	3.2 mm	40 mm	5-1/8" (13 cm)
KM48079	3.2 mm	70 mm	7-1/8" (18 cm)
KM48081	3.5 mm	42 mm	3-3/4" (9.5 cm)
KM48082	3.5 mm	50 mm	7-1/8" (18 cm)
KM48085	4.5 mm	55 mm	5-1/8" (13 cm)
KM48086	6.0 mm	70 mm Extra-Long	7-1/8" (18 cm)

## Drill Bits — Quick Coupling End

### DRILL BITS



KM48057

With quick coupling ends. To drill gliding and threaded holes. Designed to fit quick coupling handles KM47902, KM47904 and KM47960.

ITEM #	DIAMETER	FLUTE LENGTH	WORKING LENGTH	OVERALL LENGTH
KM48051	1.1 mm	20 mm	35 mm	2-3/8" (6 cm)
KM48052	1.5 mm	23 mm	60 mm	3-3/8" (8.5 cm)
KM48054	2.0 mm	50 mm	75 mm	3-7/8" (10 cm)
KM48057	2.5 mm	50 mm	85 mm	4-3/8" (11 cm)
KM48058	2.7 mm	50 mm	75 mm	3-7/8" (10 cm)
KM48061	3.2 mm	50 mm	120 mm	5-3/4" (14.5 cm)
KM48060	3.2 mm	50 mm	170 mm Extra-Long	7-5/8" (19.5 cm)
KM48063	3.5 mm	50 mm	85 mm	4-3/8" (11 cm)
KM48050	3.5 mm	50 mm	170 mm Extra-Long	7-5/8" (19.5 cm)
KM48067	4.5 mm	50 mm	120 mm	5-3/4" (14.5 cm)
KM48068	4.5 mm	50 mm	170 mm Extra-Long	7-5/8" (19.5 cm)
KM48069	6.0 mm	60 mm	170 mm Extra-Long	7-5/8" (19.5 cm)



# DRILLS, DRILL BITS AND GUIDES

## Drill Bits — Three-Fluted Drill Bits

### THREE-FLUTED DRILL BITS



With quick coupling ends.

ITEM #	DIAMETER	FLUTE LENGTH	WORKING LENGTH	OVERALL LENGTH
KM48091	2.5 mm	30 mm not calibrated	85 mm	4-3/8" (11 cm)
KM48092	2.5 mm	28 mm not calibrated	155 mm	7-1/8" (18 cm)
KM47986	2.5 mm	30 mm calibrated	205 mm	9" (23 cm)
KM48093	3.2 mm	38 mm not calibrated	120 mm	5-3/4" (14.5 cm)
KM48094	3.2 mm	38 mm not calibrated	170 mm	7-5/8" (19.5 cm)
KM47979	3.2 mm	30 mm calibrated	205 mm	9" (23 cm)
KM48095	4.5 mm	45 mm not calibrated	120 mm	5-3/4" (14.5 cm)
KM47981	4.5 mm	58 mm not calibrated	170 mm	7-5/8" (19.5 cm)





# DRILLS, DRILL BITS AND GUIDES

## Drill Bits — Countersinks

### MINI COUNTERSINK



KM47920

For mini screws 1.5/2.0 mm. Quick coupling end.

ITEM #	DESCRIPTION
KM47920	1.1 mm tip, 2-1/4" (5.5 cm)

### SMALL COUNTERSINKS



KM47922

For small screws 2.7/3.5/4.0 mm. Quick coupling end.

ITEM #	DESCRIPTION
KM47922	2.0 mm tip, 2-7/8" (7 cm)
KM47923	90 degrees, 2.0 mm tip, 2-1/2" (6 cm)

### MALLEOLAR COUNTERSINK



KM47924

For malleolar screws. Quick coupling end.

ITEM #	DESCRIPTION
KM47924	3.2 mm tip, 4-1/2" (11.5 cm)



# DRILLS, DRILL BITS AND GUIDES

## Drill Bits — Countersinks

### LARGE COUNTERSINK



For large screws 4.5/6.5 mm. Quick coupling end.

ITEM #	DESCRIPTION
KM47926	4.5 mm tip, 7-1/8" (18 cm)

## Drill Bits — Taps

### TAPS



With quick coupling ends, calibrated with cm graduations.

ITEM #	DESCRIPTION
KM48104	3.5 mm diameter, for cortical screws, 7"
KM48102	4.5 mm diameter, for cortical screws, 7"
KM48122	6.5 mm diameter, for cancellous screws, 8"

### TAPS

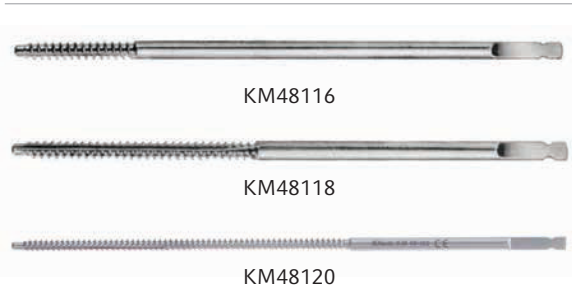

With quick coupling ends, for 4.5 mm cortical and 4.5 mm malleolar (shaft) screws.

ITEM #	DESCRIPTION
KM48116	5"
KM48118	Long thread, 5"
KM48120	Extra-long thread, 5"







# DRILLS, DRILL BITS AND GUIDES

## Drill Bits — Taps

### TAPS

Taps: Used to prepare thread path for insertion of bone screws. With quick coupling ends.

ITEM #	DESCRIPTION
KM48106	1.5 mm diameter, for cortical screws, thread pitch 0.5 mm, 2"
KM48108	2.0 mm diameter, for cortical screws, thread pitch 0.6 mm, 2-1/8"
KM48110	2.7 mm diameter, for cortical screws, thread pitch 1.0 mm, 4"
KM48112	3.5 mm diameter, fine thread, for cortical screws, thread pitch 1.25 mm, 4-3/8"
KM48114	3.5 mm diameter, coarse thread, for 3.5 and 4.0 mm cancellous screws, thread pitch 1.75 mm, 4-3/8"



KM48106



KM48108



KM48110



KM48112



KM48114





# DRILLS, DRILL BITS AND GUIDES

## Drill Guides and Sleeves

### DRILL GUIDES



Drill guide ends are color coded.  
Green = neutral  
Gold = load

ITEM #	DESCRIPTION
KM47977	2.0 mm, neutral and load end, for 2.0 mm drill bit and 2.7 mm cortical screw, 5-3/8" (13.5 cm)
KM48003	2.0 mm, neutral and load end, for 1.5 mm drill bit and 2.0 mm cortical screw, 4-3/8" (11 cm)
KM47978	2.5 mm, neutral and load end, for 2.5 mm drill bit and 3.5 mm cortical screw, 6-1/8" (15.5 cm)
KM47980	3.2 mm, neutral and load end, for 3.2 mm malleolar (shaft) drill bit and 4.5 mm cortical screw, 6-1/2" (16.5 cm)

### UNIVERSAL DRILL GUIDE



Can be used as neutral/load drill guide.

ITEM #	DESCRIPTION
KM48004	For 3.5 mm cortical screws and 3.5 mm malleolar (shaft) screws and 2.5 mm drill bits, 5-1/2" (14 cm)
KM47985	For 4.5 mm cortical screws and 4.5 mm malleolar (shaft) screws and 3.2 mm drill bits, 7-1/8" (18 cm)





# DRILLS, DRILL BITS AND GUIDES

## Drill Guides and Sleeves

### PARALLEL DRILL GUIDE AND DRILL SLEEVE



KM47970

ITEM #	DESCRIPTION
KM47970	2 mm tip, three holes and one hole for 2.0 mm drill bits, 4-1/2" (11.5 cm)

### DOUBLE DRILL SLEEVES



KM47972

ITEM #	DESCRIPTION
KM47968	For 1.1 mm and 1.5 mm drill bits and tap for 1.5 mm cortical screws
KM47966	For 1.5 mm and 2.0 mm drill bits and tap for 2.0 mm cortical screws
KM48002	For 2.0 mm and 2.7 mm drill bits and tap for 2.7 mm cortical screws
KM47972	For 2.5 mm and 3.5 mm drill bits, tap for 3.5 mm cortical screws, and tap for 4.0 mm cancellous screws
KM47967	For 3.2 mm and 4.5 mm drill bits, tap for 4.5 mm cortical screws, and tap for 4.5 mm malleolar (shaft) screws
KM47965	For 3.2 mm drill bits and tap for 6.5 mm cancellous screws

### DRILL SLEEVES



KM47976

ITEM #	DESCRIPTION
KM47976	40 mm long tip, for 3.2 mm drill bits, for round hole and semi-tubular plates, 4-1/2" (11.5 cm)
KM47982	60 mm long tip, for 3.2 mm drill bits, for round hole plates, 5" (12.5 cm)





# DRILLS, DRILL BITS AND GUIDES

## Drill Guides and Sleeves

### INSERT DRILL SLEEVE



KM47974

ITEM #	DESCRIPTION
KM47974	For 2.5 mm drill bits and long 3.5 mm lag screws, 1-5/8" (4 cm)

### INSERT DRILL SLEEVE



KM47973

ITEM #	DESCRIPTION
KM47973	For 3.2 mm drill bits and 4.5 mm lag screws, 3-1/8" (8 cm)

### TAP SLEEVES



KM47971

Also can be used as 3.2 mm drill bit guide.

ITEM #	DESCRIPTION
KM47971	For 3.2 mm drill bits, 4-1/2" (11.5 cm)





# DRILLS, DRILL BITS AND GUIDES

## Drill Guides and Sleeves

### TAP SLEEVES



KM47969

Also can be used as 4.5 mm drill bit guide.

ITEM #	DESCRIPTION
KM47969	4.5 mm diagonal, with toothed tip and tissue protector sleeve for 4.5 mm tap, 5-1/2" (14 cm)

### GUIDEWIRE W/DRILLPOINT

ITEM #	DESCRIPTION
KM48282	2 mm x 98 cm
KM48284	3 mm x 98 cm

### POINTED DRILL GUIDE



KM47975

Used with tap sleeve KM47969 or KM47967.

ITEM #	DESCRIPTION
KM47975	For 4.5 mm cortical screws, 6" (15 cm)

### TENSION DEVICE



KM47910

ITEM #	DESCRIPTION
KM47910	Span: 8 mm, 2-1/2" (6.5 cm)



# DRILLS, DRILL BITS AND GUIDES

## Drill Guides and Sleeves

### TENSION DEVICE ARTICULATED

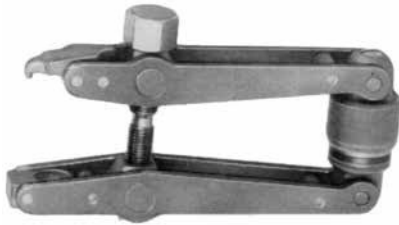

KM47911

For standard and small plates.

ITEM #	DESCRIPTION
KM47911	Span: 20 mm, 3-1/2" (9 cm)

### DRILL SLEEVE FOR TENSION DEVICE



KM47909

For 3.2 mm drill bit.

ITEM #	DESCRIPTION
KM47909	Span: 8 mm / 16 mm, 2" (5 cm)







# TREPHINES

## MICHELE TREPHINE



Designed for bone biopsy. Also facilitates removal of broken bone screws. 7-1/2" (19 cm).

ITEM #	DESCRIPTION
KM48239	Small, 3 mm I.D., 5 mm O.D.
KM48240	Medium, 4 mm I.D., 6 mm O.D.
KM48241	Large, 6 mm I.D., 8.1 mm O.D.

## P.I. PLUG CUTTER



When removing K-Wire, use the Plug Cutter to extract a tiny cylinder of bone around the tip of the wire.

ITEM #	DESCRIPTION
KM48252	3 mm I.D., 5 mm O.D., length with obturator 4-1/2" (11.5 cm)

## PLUG CUTTER



- These cutters are especially useful for arthrodesis of small and large joints by plug cutter graft technique.
- The plug cutters are designed to be used in pairs.
- The smaller diameter instrument will cut the plug opening and the larger one will harvest a bone graft that will fit into the opening.
- The plug can then be tapped into place using the Bone Impactor (KM69980).
- 6" (15 cm).

ITEM #	DESCRIPTION
KM69830	5 mm I.D., 7 mm O.D.
KM69832	7 mm I.D., 9 mm O.D.
KM69834	10 mm I.D., 12 mm O.D.
KM69836	12 mm I.D., 14 mm O.D.
KM69838	20 mm I.D., 22 mm O.D.
KM69840	22 mm I.D., 24 mm O.D.





# SCREW DRIVERS

Hex Head

## HEXAGONAL SCREWDRIVERS

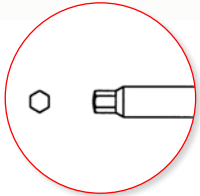

KM47952

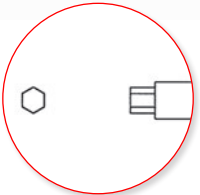

KM48349

ITEM #	DESCRIPTION
KM48369	1.5 mm screwdriver with sleeve, 7-5/8" (19.5 cm)
KM47952	2.5 mm screwdriver with sleeve, 7-7/8" (20 cm)
KM48368	2.5 mm screwdriver with notch, 8-1/4" (21 cm)
KM48349	3.5 mm with notch, 9-5/8" (24.5 cm)
KM47955	Screw holding sleeve only for KM47952, 2" (5 cm)
KM48365	Screw holding sleeve only for KM48368, 3" (8 cm)
KM47983	Screw holding sleeve only for KM48349, 5" (12.5 cm)
KM47956	Screwdriver only for KM47952

Autoclavable to 290°F (143°C)

## HEXAGONAL SCREWDRIVER SHAFT (PELVIC)



KM47951



KM47961

ITEM #	DESCRIPTION
KM47951	2.5 mm with notch, quick coupling end, 6-1/2" (16.5 cm)
KM47961	3.5 mm with notch, quick coupling end, 6-1/2" (16.5 cm)
KM48365	Sleeve only for KM47951, 3" (8 cm)
KM47983	Sleeve only for KM47961, 5" (12.5 cm)



KM48365



KM47983





# SCREW DRIVERS

Hex Head

## SCREWDRIVER SLEEVES



ITEM #	DESCRIPTION
KM48365	Sleeve only for KM47951, KM48348, KM48364, KM48368, 3" (8 cm)
KM47983	Sleeve only for KM48349, KM48353 and KM47961, 5" (12.5 cm)

## LARGE HEXAGONAL SCREWDRIVER (PELVIC)

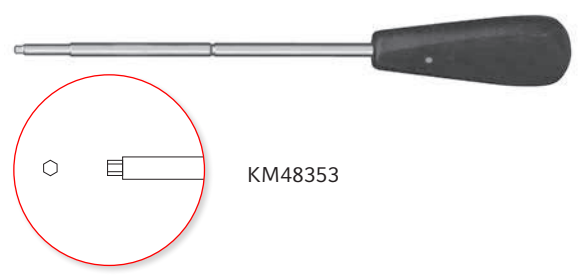

ITEM #	DESCRIPTION
KM48353	3.5 mm Screwdriver with notch, 11-3/4" (30 cm)
KM48364	Screwdriver only, 2.5 mm with notch, 11" (27 cm)
KM47983	Sleeve only for KM48353, 5" (12.5 cm)

Autoclavable to 290°F (143°C)

## LARGE HEX SCREWDRIVER WITH UNIVERSAL JOINT

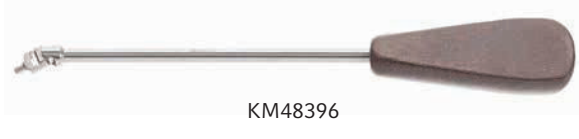

ITEM #	DESCRIPTION
KM48396	3.5 mm tip, quick coupling end, 11-5/8" (29.5 cm)

## LARGE HEXAGONAL SCREWDRIVER



ITEM #	DESCRIPTION
KM47954	3.5 mm, quick coupling end, 3-7/8" (10 cm)



# SCREW DRIVERS

Hex Head

## MINI HEXAGONAL SCREWDRIVER



ITEM #	DESCRIPTION
KM47950	1.5 mm, quick coupling end, sleeve included, 2-1/4" (5.5 cm)
KM47950B	Shaft only, 1.5 mm with notch, quick coupling end, 2" (5 cm)
KM47959	Screw holding sleeve only

## HEXAGONAL SCREWDRIVER SHAFT



ITEM #	DESCRIPTION
KM48348	2.5 mm with notch, quick coupling end, 5-1/2" (14 cm)
KM48365	Sleeve only





# SCREW DRIVERS

## Hex Head

### SCREWDRIVER



ITEM #	DESCRIPTION
KM48670	1.5 mm hexagonal
KM48350	2.5 mm hexagonal
KM48352	3.5 mm hexagonal
KM48354	Single slot
KM48356	Cruciform
KM48358	Phillips

Autoclavable to 290°F (143°C)

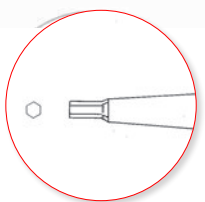

KM48350

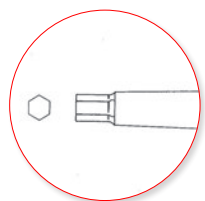

KM48352

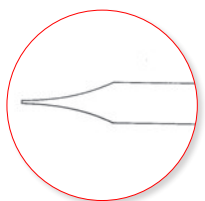

KM48354

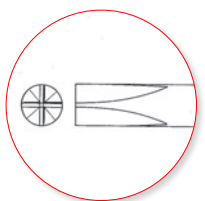

KM48356

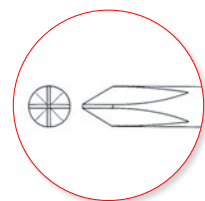

KM48358

### SINGLE SLOT SCREWDRIVER



ITEM #	DESCRIPTION
KM48355	Phenolic handle, 6-3/4" (17 cm)

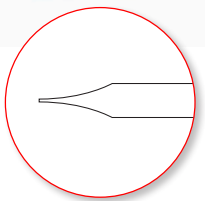

KM48355



# SCREW DRIVERS

## Cruciform Head

### CRUCIFORM SCREWDRIVER

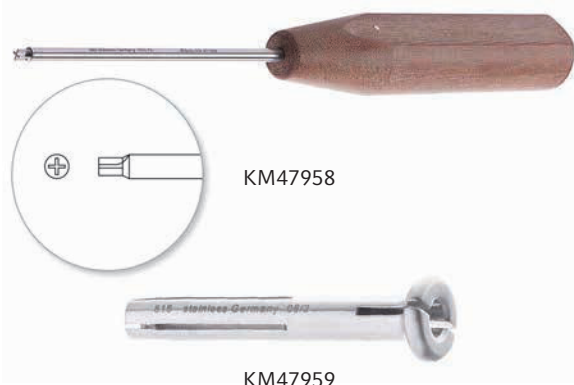

ITEM #	DESCRIPTION
KM47957	1.5 / 2.0 mm screwdriver with sleeve, 7-1/2" (19 cm)
KM47959	Screw holding sleeve only for KM47957
KM47958	Screwdriver only for KM47957

Autoclavable to 290°F (143°C)

### MINI CRUCIFORM SCREWDRIVER BIT



ITEM #	DESCRIPTION
KM45004	1.5 / 2 mm quick coupling end, 2-1/2" (6.5 cm)







# SCREW DRIVERS

## T-Handle

### LARGE HEX SCREWDRIVER W/ T-HANDLE

ITEM #	DESCRIPTION
KM48395	3.5 mm, quick coupling end, 6-7/8" (17.5 cm)

## Depth Gauge

### SCREW DEPTH GAUGES



KM47934

Used to determine screw length required during internal fracture fixation (mm graduated). Snaps apart for easy cleaning. **IMPORTANT NOTE:** When not in use, retract measuring end inside gauge for probe protection.

ITEM #	DESCRIPTION
KM47934	Mini, up to 30 mm, 4-3/4" (12 cm)
KM47936	Small, up to 50 mm, 6-1/4" (16 cm)
KM47940	Large, up to 100 mm, 8-3/4" (22 cm)
KM47935	Extra-long, up to 120 mm, 11" (28 cm)



# SCREW DRIVERS

## Screw Driver Sets

### INTERCHANGEABLE SCREWDRIVER SET



KM48471



KM48473



KM48474



KM48475



KM48476



KM48477

ITEM #	DESCRIPTION
KM48471	Complete set with sterilization case
KM48473	Screwdriver handle. Allows K-Wire and pins to be inserted with Jacobs Universal Chuck KM48478. Cannulation 1/4" (6.3 mm), includes key, 5-1/2" (14 cm)
KM48474	Single slot, 5-1/2" (14 cm)
KM48475	Cruciform, 5-1/2" (14 cm)
KM48476	Phillips, 5-1/2" (14 cm)
KM48477	Small Phillips, 5-1/2" (14 cm)
KM48478	Jacobs Universal Chuck. Allows K-Wire and pins to be inserted with Jacobs chuck. Cannulation 1/4" (6.3 mm), includes key, 3" (7.5 cm)
KM48478P	Key for KM48478 Jacobs Universal Chuck
KM48479	3.5 mm diameter, 5-1/2" (14 cm)
KM48480	2.5 mm diameter, 5-1/2" (14 cm)



KM48478



KM48479



KM48480

### MINI SCREW FIXATION SET

ITEM #	DESCRIPTION
KM48414	Mini Screw Fixation Set

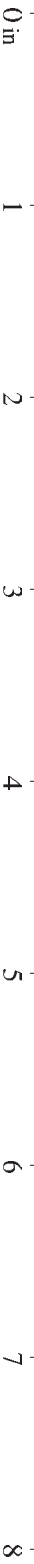



# SCREW DRIVERS

## Screw Holding Forceps

### SELF-RETAINING SCREW HOLDING FORCEPS



ITEM #	DESCRIPTION
KM47930	3-1/2" (9 cm)

### SELF-RETAINING SCREW HOLDING FORCEPS



ITEM #	DESCRIPTION
KM45208	For 1.5 mm to 2.7 mm screws
KM45210	For 3.5 mm to 6.5 mm screws





# BENDING IRONS AND ROD HOLDERS

## UNIVERSAL ROD BENDER



KM46664

ITEM #	DESCRIPTION
KM46664	11-1/4" (28.5 cm)

## IN SITU ROD BENDERS



KM49780

KM49781

Used in pairs, 13" (33 cm).

ITEM #	DESCRIPTION
KM49780	Right, bends 3/16" (4.76 mm) rods
KM49781	Left, bends 3/16" (4.76 mm) rods
KM49782	Right, bends 1/4" (6.35 mm) rods
KM49783	Left, bends 1/4" (6.35 mm) rods

## ONE-HANDED ROD BENDER



KM49812

For 3 mm and 4 mm diameter rods.

ITEM #	DESCRIPTION
KM49812	7-1/2" (19 cm)





# BENDING IRONS AND ROD HOLDERS

## ROD HOLDERS

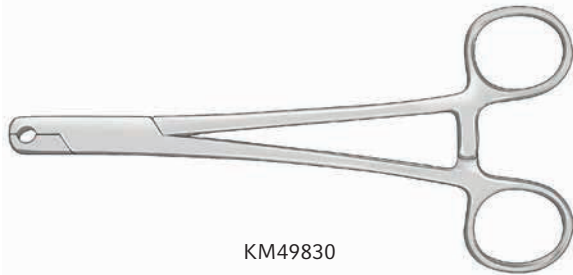

KM49830

With ratchet, 7-1/4" (18.5 cm).

ITEM #	DESCRIPTION
KM49830	Holds 5/32" (4.0 mm) rods
KM49831	Holds 3/16" (4.76 mm) rods
KM49832	Holds 1/4" (6.35 mm) rods

## ROD HOLDERS



KM49706

Curved tip, with ratchet, 8-1/4" (21 cm).

ITEM #	DESCRIPTION
KM49701	Threaded hole, holds 5/32" (4.0 mm) rods
KM49702	Threaded hole, holds .177" (4.5 mm) rods
KM49706	Without threaded hole, holds .197" (5.0 mm) rods

## ROD HOLDER

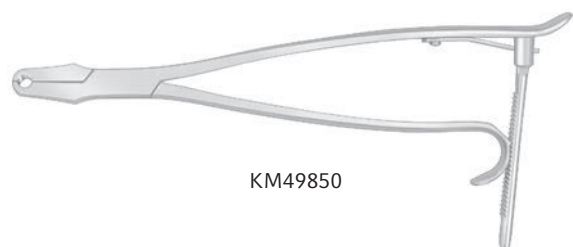

KM49850

With ratchet, 10" (25.5 cm).

ITEM #	DESCRIPTION
KM49850	Holds 1/4" (6.35 mm) rods, threaded hole
KM49848	Prism holds 0.197" (5 mm) and 5.5 mm rods

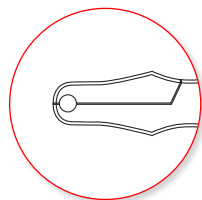

KM49850

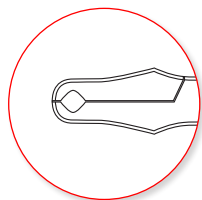

KM49848





# BENDING IRONS AND ROD HOLDERS

## MINI PLATE BENDING IRON



KM47917

For mini and finger plates.

ITEM #	DESCRIPTION
KM47917	4-3/4"

## SMALL PLATE BENDING IRONS

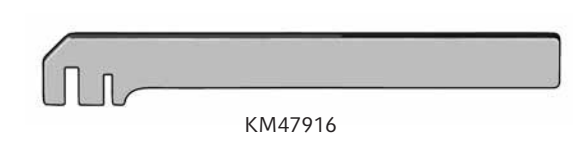

KM47916

Used in pairs. For 3.5 mm and 2.7 mm plates.

ITEM #	DESCRIPTION
KM47916	5-1/2" (14 cm)
KM47915	5-1/2" (14 cm)

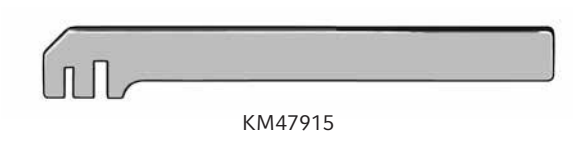

KM47915

## STANDARD PLATE BENDING IRON



KM47918

For standard plates, with 4 holes.

ITEM #	DESCRIPTION
KM47918	9-1/2"

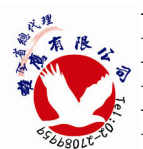





# BENDING IRONS AND ROD HOLDERS

## PLATE BENDING IRON



ITEM #	DESCRIPTION
KM47919	For 3.5 mm and 4.5 mm plates

## BENDING IRONS



ITEM #	DESCRIPTION
KM45501	For 0.8 - 1.25 mm K-Wires, 4-1/2" (11.5 cm)
KM45502	For 1.25, 1.6 and 2 mm K-Wires, 4-3/4" (12 cm)

## BENDING TEMPLATES

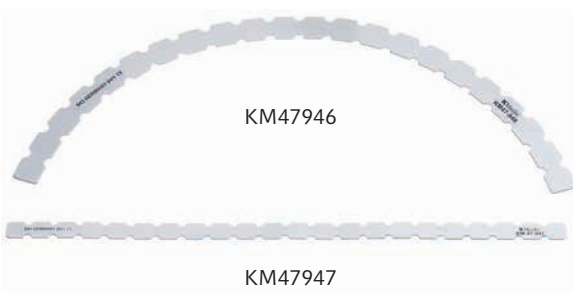

Anodized aluminum reconstruction plates.

ITEM #	DESCRIPTION
KM47946	22 holes, 3.5 mm, 8-1/4" (21 cm), curved
KM47947	22 holes, 3.5 mm, 10-3/8" (26 cm), straight
KM47948	16 holes, 4.5 mm, 10" (25.5 cm), straight





# BENDING IRONS AND ROD HOLDERS

## BENDING TEMPLATES



To simulate required plate bending. Anodized aluminum, color coded.

ITEM #	DESCRIPTION
KM47944	For small plates, 2-1/2" (6.5 cm)
KM47945	For small plates, 3-1/2" (9 cm)
KM47941	5 holes, 3-1/2" (9 cm)
KM47942	7 holes, 4-1/2" (11.5 cm)
KM47943	9 holes, 6" (15 cm)

## BENDING TEMPLATES



Anodized aluminum.

ITEM #	DESCRIPTION
KM45126	5 holes, 3.5 mm, 2-1/2" (6 cm)
KM45127	7 holes, 3.5 mm, 3-3/8" (8.5 cm)
KM45128	9 holes, 3.5 mm, 4-3/8" (11 cm)
KM45122	9 holes, 4.5 mm, 6-1/8" (15.5 cm)

## PLATE HOLDING CLIPS

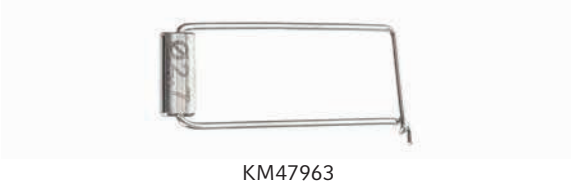

ITEM #	DESCRIPTION
KM47962	2.0 mm
KM47963	2.7 mm
KM47964	3.5 mm





# ORTHOPEDIC RETRACTORS

## Hand-Held Orthopedic Retractors

### FRAZIER HOOKS



5" (12.5 cm).

ITEM #	DESCRIPTION
KM48158	1 sharp prong, 2.5 mm diameter
KM48161	1 blunt prong, 2.5 mm diameter

### GILLIES HOOKS



7" (18 cm).

ITEM #	DESCRIPTION
KM58077	Small
KM58083	Large

### ADSON DISSECTOR HOOKS



8" (20.5 cm).

ITEM #	DESCRIPTION
654180	Blunt
654181	Sharp





# ORTHOPEDIC RETRACTORS

## Hand-Held Orthopedic Retractors

### FRAZIER DURA HOOKS



ITEM #	DESCRIPTION
654190	Blunt, 4-3/4" (12 cm)
654191	Sharp, 4-7/8" (12.5 cm)

### HOEN HOOKS



9-1/4" (23.5 cm).

ITEM #	DESCRIPTION
594400	Short prong
594402	Long prong

### SNOOK HOOK



Veterinary.

ITEM #	DESCRIPTION
KM71431	8" (20.5 cm)

### SMITHWICK DISSECTOR AND HOOK



ITEM #	DESCRIPTION
622700	12-1/4" (31 cm)





# ORTHOPEDIC RETRACTORS

## Hand-Held Orthopedic Retractors

### HOLSHER NERVE RETRACTORS



Primarily used to retract the nerve root. Blunt hook. 9-1/2" (24 cm).

ITEM #	DESCRIPTION
KM48234	7 mm blade
KM48237	9 mm blade

### NERVE ROOT RETRACTOR



Retractor blade lies on same plane as surgeon's finger. Gives surgeon unobstructed view.

ITEM #	DESCRIPTION
KM55424	6 mm blade, 8-1/4" (21 cm)

### BAYONET NERVE RETRACTOR

ITEM #	DESCRIPTION
KM46932	7 mm wide x 1 mm deep blade





# ORTHOPEDIC RETRACTORS

## Hand-Held Orthopedic Retractors

### SCOVILLE NERVE ROOT RETRACTORS



KM55426

Angled.

ITEM #	DESCRIPTION
KM55426	8 mm blade, 8" (20.5 cm)
KM55428	13 mm blade, 7-5/8" (19.5 cm)

### PERPENDICULAR NERVE RETRACTOR

ITEM #	DESCRIPTION
KM46930	7 mm wide x 1 mm deep blade angled 90 degrees

### RAGNELL-LINDE RETRACTOR

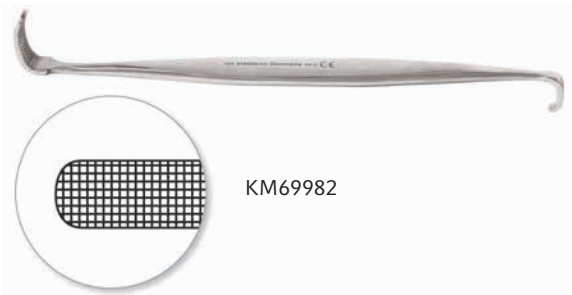

KM69982

Fine cross serrations help prevent slippage.  
Double ended with serrations, 5-1/4" (13.5 cm).

ITEM #	DESCRIPTION
KM69982	4 x 8 mm and 6 x 15 mm blades







# ORTHOPEDIC RETRACTORS

## Hand-Held Orthopedic Retractors

### BLADE RETRACTORS



KM55421

ITEM #	DESCRIPTION
KM55420	18 mm wide blade, 7" (18 cm)
KM55421	20 mm wide blade, 7" (18 cm)
KM55422	23 mm wide blade, 7" (18 cm)

### LANGENBECK RETRACTORS



KM51104

ITEM #	DESCRIPTION
KM51100	#1, 3/8" x 1-1/4" (10 x 32 mm), 8-7/8" (22.5 cm)
KM51104	#2, 3/8" x 1-3/4" (10 x 45 mm), 8" (20.5 cm)
KM51108	#3, 1/2" x 1-3/4" (15 x 45 mm), 8-1/2" (21.5 cm)
KM51112	#4, 5/8" x 1-1/2" (16 x 38 mm), 8" (20.5 cm)

### DEEP RAKE RETRACTORS



KM52294

10-1/2" (26.5 cm).

ITEM #	DESCRIPTION
KM52292	4 blunt prongs, 2-1/4" wide x 1-1/2" deep (5.5 x 4 cm)
KM52294	4 blunt prongs, 2-1/4" wide x 2" deep (5.5 x 5 cm)
KM52296	4 blunt prongs, 2-1/4" wide x 2-1/2" deep (5.5 x 6.5 cm)
KM52298	4 blunt prongs, 2-1/4" wide x 3" deep (5.5 x 7.5 cm)





# ORTHOPEDIC RETRACTORS

## Hand-Held Orthopedic Retractors

### ISRAEL RAKE RETRACTORS



9-1/2" (24 cm).

ITEM #	DESCRIPTION
KM51078	3 blunt prongs, 30 mm wide x 37 mm deep
KM51080	4 blunt prongs, 40 mm wide x 40 mm deep

### OLLIER RAKE RETRACTOR



ITEM #	DESCRIPTION
KM52282	4 blunt prongs, 55 mm wide x 40 mm deep blade, 9" (23 cm)

### MEYERDING LAMINECTOMY RETRACTORS



Sharp teeth.

ITEM #	DESCRIPTION
KM51158	Small, 17 mm wide blade, 9-1/2" (24 cm)
KM51162	Medium, 25 mm wide blade, 9-1/2" (24 cm)
KM51164	Large, 50 mm wide blade, 10" (25.5 cm)



# ORTHOPEDIC RETRACTORS

## Hand-Held Orthopedic Retractors

### TAYLOR SPINAL RETRACTORS



KM52458

ITEM #	DESCRIPTION
KM52458	1-1/4" wide x 3" long blade (3 x 7.5 cm), 7-3/4" (19.5 cm)
KM52460	1-1/4" wide x 4" long blade (3 x 10 cm), 7-3/4" (19.5 cm)

### TAYLOR RETRACTORS



KM46936

ITEM #	DESCRIPTION
KM46934	Distal tip 3/4" wide and 3" long (20 x 76 mm), overall length 8-1/8" (20.5 cm)
KM46936	Distal tip 3/4" wide and 4" long (20 x 102 mm), overall length 8-1/8" (20.5 cm)

### HIBBS RETRACTORS



KM51060

Used for deep soft tissue retraction. Sharp teeth, 9-1/2" (24 cm).

ITEM #	DESCRIPTION
KM51059	25 mm wide x 50 mm deep blade
KM51060	26 mm wide x 75 mm deep blade
KM51061	25 mm wide x 100 mm deep blade



# ORTHOPEDIC RETRACTORS

## Hand-Held Orthopedic Retractors

### AUFRANC COBRA RETRACTORS

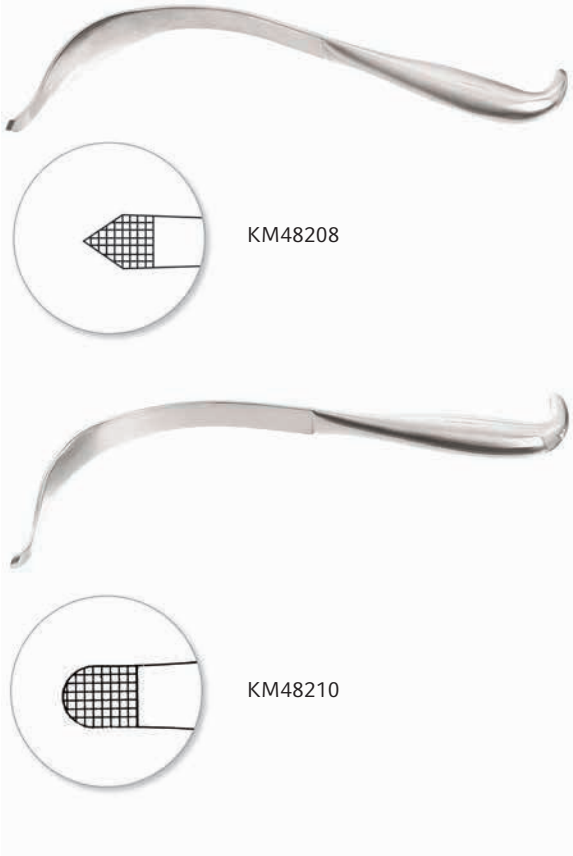

With hollow handle, 1-1/4" wide blade, 10-1/2" (26.5 cm).

ITEM #	DESCRIPTION
KM48208	Serrated, pointed tip, 10 mm
KM48212	Smooth, blunt tip, 10 mm
KM48210	Serrated, blunt tip, 10 mm
KM48214	Smooth, pointed tip, 10 mm

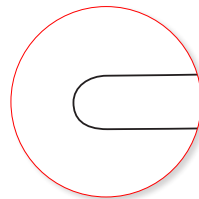

KM48212

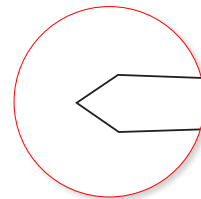

KM48214

### BENNETT BONE ELEVATOR AND RETRACTORS



Hollow handle, 10" (25.5 cm).

ITEM #	DESCRIPTION
KM46880	Small, 1-3/4" (4.5 cm) wide blade
KM46884	Large, 2-1/2" wide blade





# ORTHOPEDIC RETRACTORS

## Hand-Held Orthopedic Retractors

### PELVIC RETRACTOR



KM48201



ITEM #	DESCRIPTION
KM48201	1" (24 mm) wide blade, 1/2" (12 mm) wide distal tip, 10-5/8" (27 cm)

### MURPHY BONE SKID



KM46892

ITEM #	DESCRIPTION
KM46892	11-3/4" (30 cm)





# ORTHOPEDIC RETRACTORS

## Shoulder and Knee Retractors

### FUKUDA STYLE SHOULDER RETRACTORS



7" (18 cm).

ITEM #	DESCRIPTION
KM46906	1-1/2" wide x 3-1/4" long blade (4 x 8 cm)
KM46907	1-1/4" wide x 3-1/4" long blade (3 x 8 cm)

### CAPSULE RETRACTOR



ITEM #	DESCRIPTION
KM46908	3 sharp prongs, 22 mm wide blade, 10" (25.5 cm)

### BRISTOW/BANKART SOFT TISSUE RETRACTOR



ITEM #	DESCRIPTION
KM46872	3 blunt prongs, 21 mm wide blade, 7-7/8" (20 cm)





# ORTHOPEDIC RETRACTORS

## Shoulder and Knee Retractors

### BRISTOW/BANKART HUMERAL RETRACTOR



ITEM #	DESCRIPTION
KM46870	2 blunt prongs, 25 mm wide x 102 mm deep, 7-1/2" (19 cm)

### HUMERAL HEAD RETRACTOR



ITEM #	DESCRIPTION
KM46860	18 mm wide blade, 8-3/4" (22 cm)

### SUBACROMION SPREADERS



ITEM #	DESCRIPTION
KM46920	Right
KM46921	Left





# ORTHOPEDIC RETRACTORS

## Shoulder and Knee Retractors

### BLOUNT DOUBLE PRONG RETRACTOR



ITEM #	DESCRIPTION
KM48204	1-3/4" (44 mm) wide blade, 10-1/2" (26.5 cm)

### BLOUNT KNEE RETRACTOR



ITEM #	DESCRIPTION
KM48206	6 mm wide distal tip, 6-7/8" (17.5 cm)

### BLOUNT SINGLE PRONG RETRACTOR



ITEM #	DESCRIPTION
KM48202	1-1/2" (37 mm) width blade, 10-1/2" (26.5 cm)





# ORTHOPEDIC RETRACTORS

## Shoulder and Knee Retractors

### SMILLIE KNEE RETRACTORS

5-1/2" (14 cm).

ITEM #	DESCRIPTION
KM48192	Reverse curve, 13 mm wide x 55 mm long blade
KM48198	19 mm wide x 30 mm long blade
KM48194	19 mm wide x 45 mm long blade
KM48196	19 mm wide x 60 mm long blade
KM48200	Full curve, 13 mm wide x 18 mm long blade

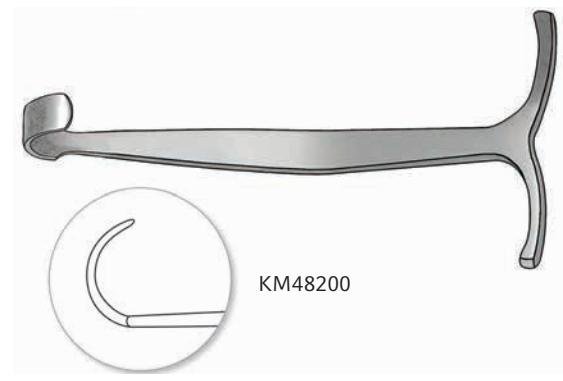
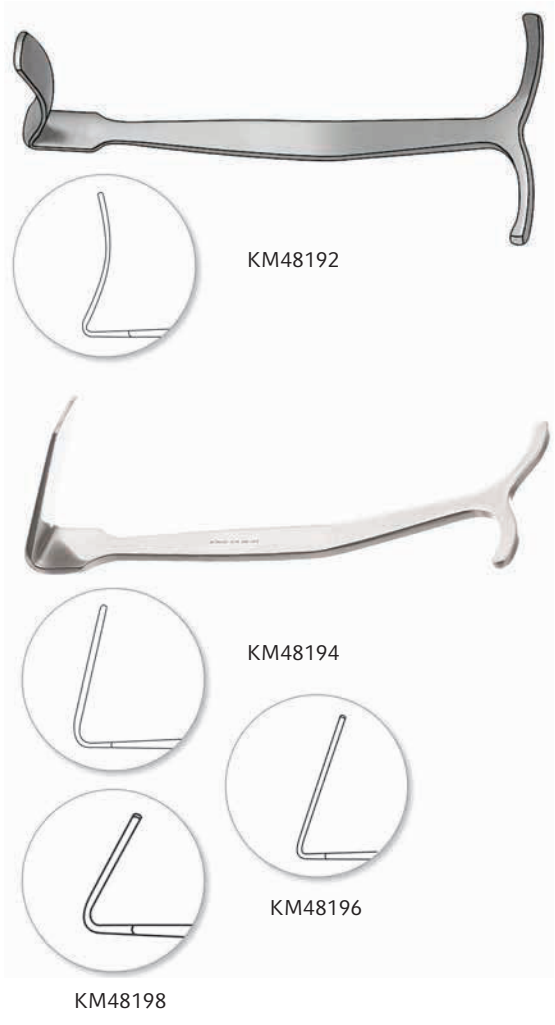

# ORTHOPEDIC RETRACTORS

## Hohmann Retractors

### HAYES HAND RETRACTORS



Used to elevate carpals and phalanges during hand procedures.

ITEM #	DESCRIPTION
KM46823	3 mm wide distal tip, 6-1/4" (16 cm)
KM46829	6 mm wide distal tip, 6" (15 cm)

### MINI HOHMANN RETRACTORS

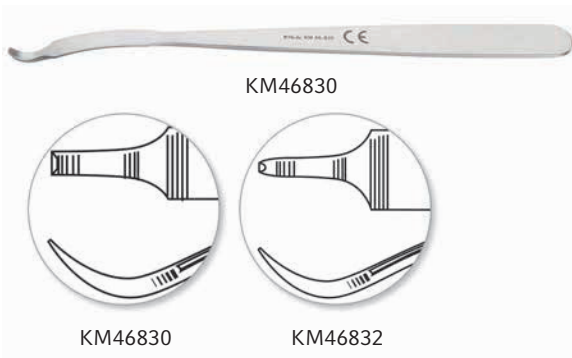

6-1/2" (16.5 cm).

ITEM #	DESCRIPTION
KM46830	6 mm wide blade
KM46832	8 mm wide blade





# ORTHOPEDIC RETRACTORS

## Hohmann Retractors

### HOHMANN RETRACTORS

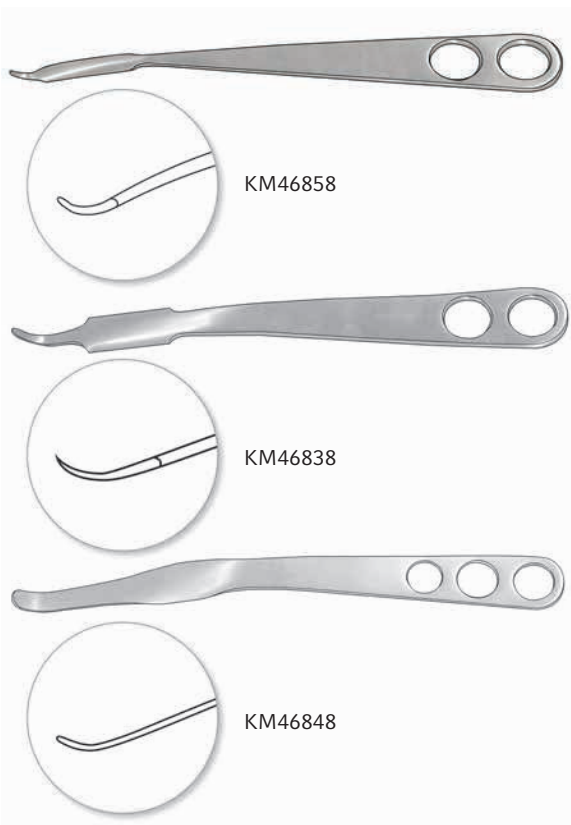

ITEM #	DESCRIPTION
KM46858	8 mm wide blade, 8-1/2" (21.5 cm)
KM46836	10 mm wide blade, 9" (23 cm)
KM46838	18 mm wide blade, 9" (23 cm)
KM46848	22 mm wide blade, three holes, 11" (28 cm)





# ORTHOPEDIC RETRACTORS

## Hohmann Retractors

### HOHMANN RETRACTORS

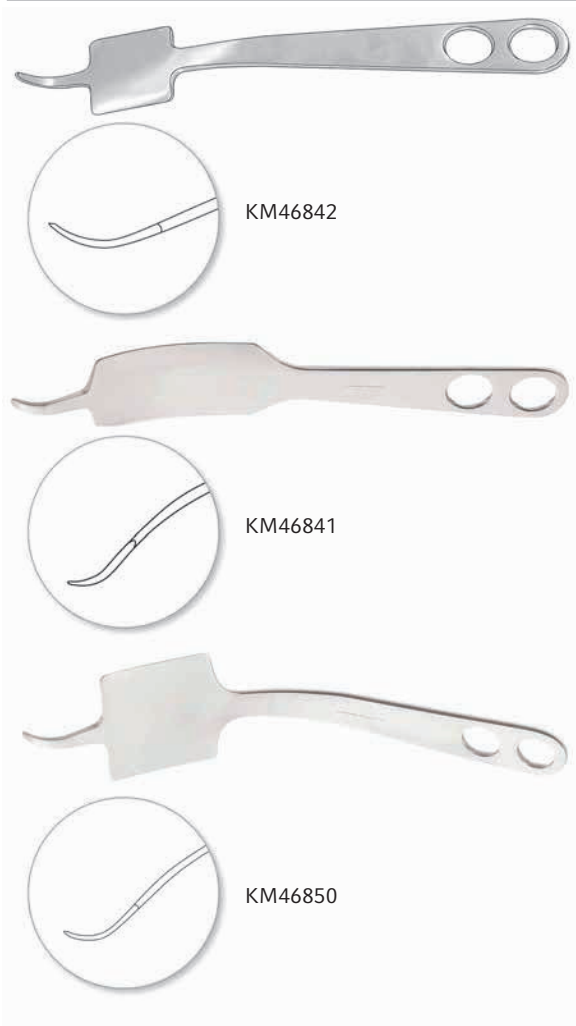

ITEM #	DESCRIPTION
KM46842	43 mm wide blade, 9-1/2" (24 cm)
KM46841	43 mm wide blade, long 64 mm shank, 9" (23 cm)
KM46850	70 mm wide blade, 9-1/2" (24 cm)

### HOHMANN RETRACTORS

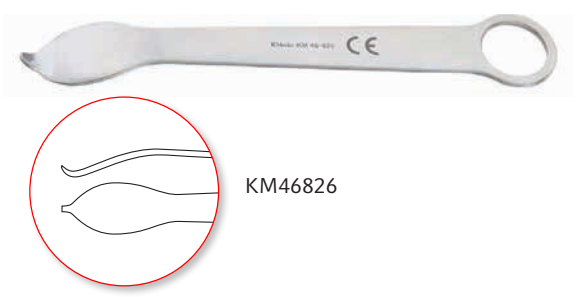

For small fragments.

ITEM #	DESCRIPTION
KM46826	Finger ring handle, broad tip, 16 mm wide blade, 4-3/4" (12 cm)

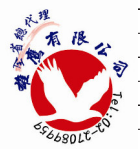



# ORTHOPEDIC RETRACTORS

## Hohmann Retractors

### HOHMANN RETRACTORS



KM46827

ITEM #	DESCRIPTION
KM46827	Broad tip, 15 mm wide blade, 6" (15 cm)

### HOHMANN RETRACTORS

Useful in exposing acetabulum.

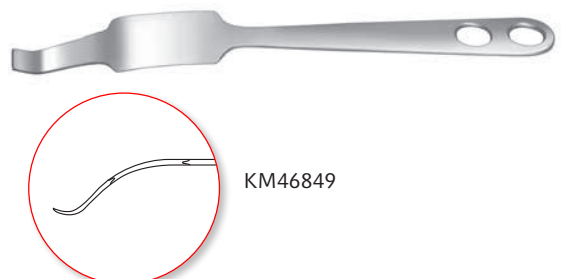

KM46849

ITEM #	DESCRIPTION
KM46849	35 mm wide blade with wide tip, long 52 mm shank, 11-1/4" (28.5 cm)
KM46852	22 mm wide blade curved 120 degrees, 16" (40.5 cm)
KM46854	40 mm wide blade curved 90 degrees, 13" (33 cm)

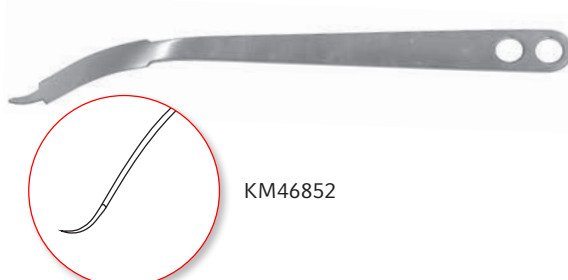

KM46852

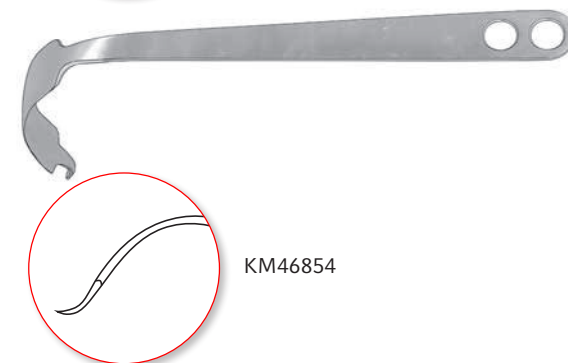

KM46854



# VICKERS FINGER RETRACTOR

The new KMedic® Vickers Retractors are designed to provide excellent visibility during hand and wrist procedures. Each of the retractors is self-retaining and automatically expands the wound site.

Ideal for retracting wounds on either the front, back or sides of fingers or thumb.



## VICKERS FINGER RETRACTOR

KM52425

2" x 3/4" x 1-1/4"

(51 mm x 19 mm x 32 mm)

2 x 2 blunt hooks

Maximum opening: 19 mm







# ORTHOPEDIC RETRACTORS

## Self-Retaining Orthopedic Retractors

### VICKERS LOW PROFILE SMALL WOUND RETRACTOR



KM52426

Useful for small wound retraction.

ITEM #	DESCRIPTION
KM52426	10 mm deep x 12 mm high, curved, smooth blades, maximum opening 30 mm, center blade 10 mm x 16 mm, 2-1/2" x 3" (6.5 x 7.5 cm)

### VICKERS LOW PROFILE HAND RETRACTOR



KM52427

With three blunt prongs to secure placement.

ITEM #	DESCRIPTION
KM52427	3 x 3 prongs, 3-1/4" (8.5 cm)

### VICKERS UNIVERSAL RETRACTOR



KM52428

With two blunt prongs to secure placement.

ITEM #	DESCRIPTION
KM52428	2 x 2 blunt prongs, 8 mm deep x 17 mm high, maximum opening 30 mm, center blade 10 mm x 16 mm, 2-1/2" x 3" (64 x 75 mm)





# ORTHOPEDIC RETRACTORS

## Self-Retaining Orthopedic Retractors

### COX METATARSAL SPREADER

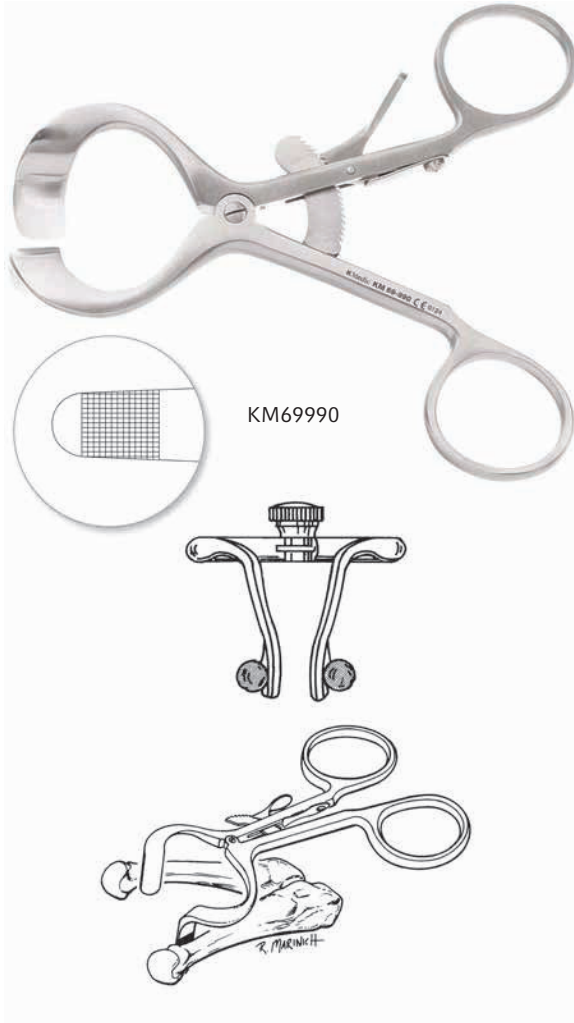

KM69990

- Specially designed thin serrated blades fit anatomically correct against the metatarsals.
- Precise design assures slip-proof hold on metatarsals.
- Affords excellent visibility for the surgeon.
- Designed by Dr. Kenneth Cox.
- A KMedic® Exclusive Product.

ITEM #	DESCRIPTION
KM69990	11 mm wide blades, 4-1/2" (11.5 cm)

### MALTZ-SEEBURGER RETRACTORS



KM58240

ITEM #	DESCRIPTION
KM58240	4-1/2" (11.5 cm)
KM58242	5-1/2" (14 cm)





# ORTHOPEDIC RETRACTORS

## Self-Retaining Orthopedic Retractors

### SNITMAN ENDAURAL RETRACTOR



ITEM #	DESCRIPTION
KM55497	3 x 3 sharp prongs

### TISSUE RETRACTOR

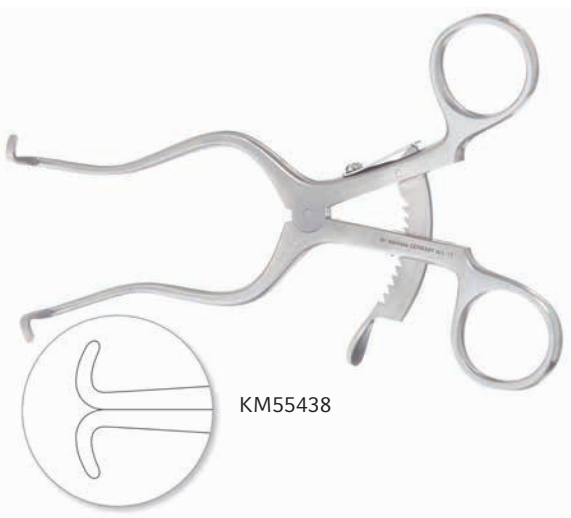

ITEM #	DESCRIPTION
KM55438	1 x 1 blunt prongs, 13 mm deep, 5-1/4" (13.5 cm)





# ORTHOPEDIC RETRACTORS

## Self-Retaining Orthopedic Retractors

### KOLBEL SOFT TISSUE RETRACTOR



KM46922

ITEM #	DESCRIPTION
KM46922	Angled, 2 x 2-pronged, 7" (18 cm)

### SCALP CONTOUR RETRACTORS



KM52546

Useful in hand procedures because handle is non-obstructive.

ITEM #	DESCRIPTION
KM52546	3 x 4 blunt prongs, 5-1/2" (14 cm)
KM52548	3 x 4 sharp prongs, 5-1/2" (14 cm)





# ORTHOPEDIC RETRACTORS

## Self-Retaining Orthopedic Retractors

### D'ERRICO-ADSON RETRACTOR



Angular prongs are heavier than those on a standard Adson.

ITEM #	DESCRIPTION
KM55498	4 x 4 sharp prongs, 3/4" (2 cm) deep blade, 7-3/8" (19 cm)

### MISKIMON CEREBELLUM RETRACTOR



ITEM #	DESCRIPTION
KM55499	7 x 7 prongs, 35 mm deep x 32 mm high, 7-1/2" (19 cm)





# ORTHOPEDIC RETRACTORS

Self-Retaining Orthopedic Retractors

## MEYERDING LAMINECTOMY RETRACTORS



KM55431

Sharp blades, 6-1/2" (16.5 cm).

ITEM #	DESCRIPTION
KM55430	Blades 57 mm deep x 25 mm wide
KM55431	Blades 51 mm deep x 25 mm wide
KM55432	Blades 41 mm deep x 25 mm wide

## MARKHAM-MEYERDING HEMILAMINECTOMY RETRACTORS



KM55440

KM55441

ITEM #	DESCRIPTION
KM55440	Left sharp blade 60 mm deep x 25 mm wide, 7" (18 cm)
KM55441	Right sharp blade 60 mm deep x 25 mm wide, 7" (18 cm)





# ORTHOPEDIC RETRACTORS

## Self-Retaining Orthopedic Retractors

### CERVICAL RETRACTOR SET

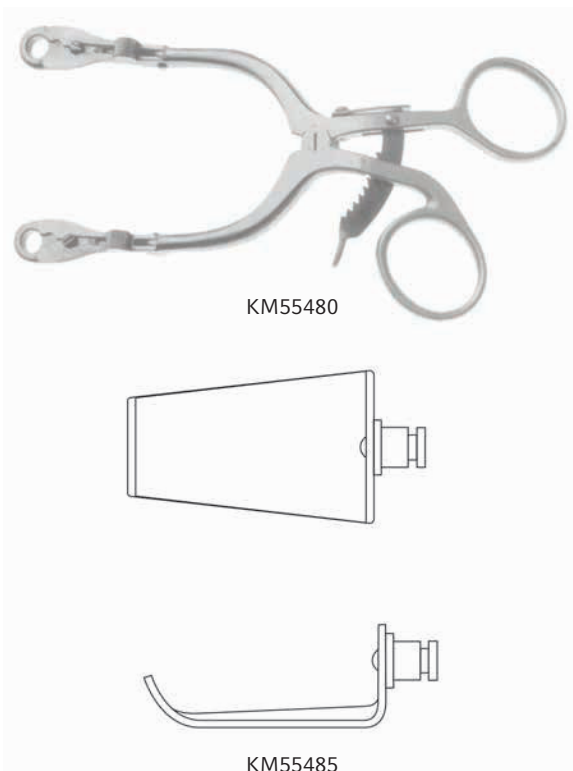

ITEM #	DESCRIPTION
KM55480	Set includes KM55481 and 7 pairs of blunt blades
KM55481	Cervical retractor body, small, 6" (15 cm)
KM55482	25 mm deep blade, blunt
KM55483	30 mm deep blade, blunt
KM55484	35 mm deep blade, blunt
KM55485	40 mm deep blade, blunt
KM55486	45 mm deep blade, blunt
KM55487	50 mm deep blade, blunt
KM55488	55 mm deep blade, blunt

### GELPI-SELETZ RETRACTOR



ITEM #	DESCRIPTION
KM52765	Sharp points, deep blades, 6-1/4" (16 cm)







# ORTHOPEDIC RETRACTORS

## Self-Retaining Orthopedic Retractors

### WILTSE-GELPI RETRACTOR

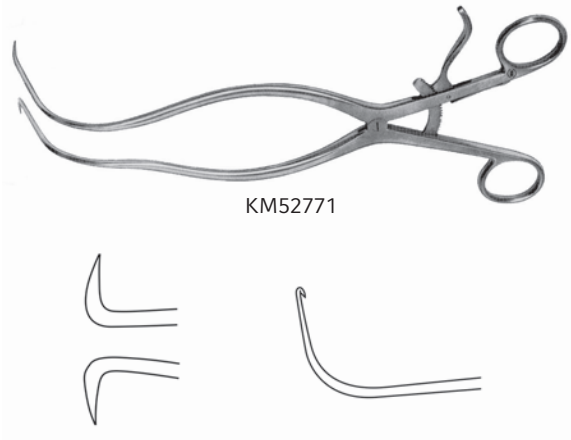

KM52771

ITEM #	DESCRIPTION
KM52771	Deep blades, sharp points, 10-7/8" (27.5 cm)

### ADSON RETRACTOR



KM52474

Hinged arm design.

ITEM #	DESCRIPTION
KM52474	4 x 5 blunt prongs, 13" (33 cm)

### BECKMAN RETRACTOR



KM52470

ITEM #	DESCRIPTION
KM52470	4 x 4 sharp prongs, 27 mm, side blade 5/8" (1.5 cm) deep, 12-1/4" (31 cm)
KM52472	4 x 4 blunt prongs, 27 mm, side blade 5/8" (1.5 cm) deep, 12-1/4" (31 cm)





# ORTHOPEDIC RETRACTORS

## Self-Retaining Orthopedic Retractors

### BECKMAN-EATON RETRACTOR



KM52476

ITEM #	DESCRIPTION
KM52476	7 x 7 sharp prongs, 40 x 48 mm, 12-1/4" (31 cm)

### BECKMAN-ADSON LAMINECTOMY RETRACTORS



KM52484

4 x 4 prongs, hinged blades 25 mm high, 12-1/4" (31 cm).

ITEM #	DESCRIPTION
KM52484	Blunt, 25 mm deep
KM52488	Blunt, 44 mm deep, max. opening 6"
KM52486	Sharp, 44 mm deep
KM52490	Sharp, 25 mm deep, max. opening 5-11/16"

### BECKMAN-WEITLANER RETRACTORS



KM52542

With hinged blades. KMedic® Pattern, satin finish, 9-1/2" (24 cm).

ITEM #	DESCRIPTION
KM52542	3 x 4 sharp prongs, 22 mm
KM52544	3 x 4 blunt prongs, 22 mm

### HORIZONTAL RETRACTOR

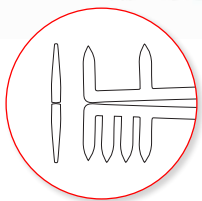

KM52602

Primarily used to retract detached trochanter from the stump of the femoral neck. Hinged arms allow handles to be angled away from surgical site to minimize interference.

ITEM #	DESCRIPTION
KM52602	Hinged blades, 4 x 2 sharp prongs, 12-1/4"



# ORTHOPEDIC RETRACTORS

## Self-Retaining Orthopedic Retractors

### VERTEBRA SPREADER (CLOWARD)



ITEM #	DESCRIPTION
KM55490	#1 with ratchet, 3/4" (19 mm) spread, 5" (12.5 cm)

### LUMBAR LAMINA SPREADERS



ITEM #	DESCRIPTION
KM55495	#1, arm length, 3-1/2" (9 cm), 5-1/4" (13.5 cm)
KM55496	#2, arm length, 4-1/4" (11 cm), 5-1/4" (13.5 cm)

### VERTEBRAL BODY DISTRACTORS



ITEM #	DESCRIPTION
KM55410	Small
KM55412	Large, 11 mm wide x 3.8 mm deep jaws, 11-1/4" (28.5 cm)





# ORTHOPEDIC RETRACTORS

## Self-Retaining Orthopedic Retractors

### INGE RETRACTOR



KM48217

Available with or without teeth.

ITEM #	DESCRIPTION
KM48217	With teeth, 6-1/2" (16.5 cm)
KM48218	Without teeth, 6-1/2" (16.5 cm)
KM48230	With teeth, 10-3/8" (26.5 cm)

### SAXENA BONE GRAFTING RETRACTOR



KM48220

- Ratchet is calibrated in millimeters to accurately assess how wide the lateral portion of the bone graft needs to be.
- Helpful in many types of procedures to accurately assess the amount of bone graft needed, such as for fusions and nonunions.
- Available exclusively from KMedic®.

ITEM #	DESCRIPTION
KM48220	35 mm graduated ratchet, 6-1/2" (16.5 cm)



# ORTHOPEDIC RETRACTORS

Self-Retaining Orthopedic Retractors

## LAMINA SPREADERS



KM48226

ITEM #	DESCRIPTION
KM48228	Concave blades, 10-1/2" (26.5 cm)
KM48226	Flat blades, 10-3/4" (27.5 cm)

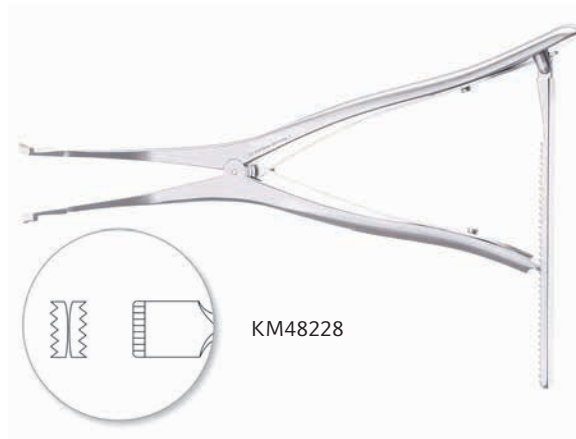

KM48228





# ORTHOPEDIC RETRACTORS

## Self-Retaining Orthopedic Retractors

### INITIAL INCISION (CHARNLEY) RETRACTOR

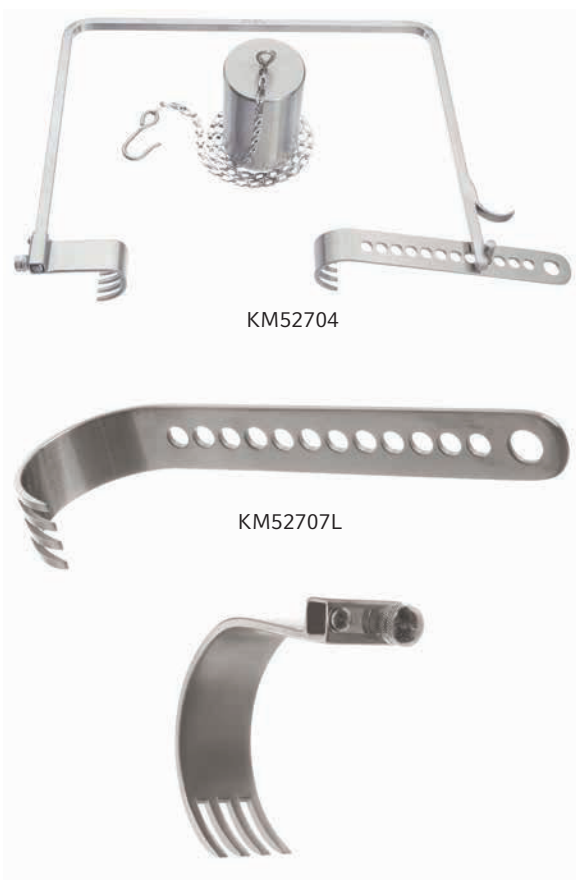

Used primarily for hip procedures.

ITEM #	DESCRIPTION
KM52704	4 sharp prongs, stainless steel, maximum retraction width 9-3/4" (24.5 cm), prong depth 1-1/4" (32 mm), blade width 1" (25 mm), weight 3 lbs. Other blades are available
KM52704F	Frame only
KM52704S	Short blade, 1-1/4" deep x 1" wide (34 x 25 mm)
KM52705S	Short blade, 2" deep x 1" wide (51 x 25 mm)
KM52706S	Short blade, 2-1/4" deep x 1" wide (57 x 25 mm)
KM52707S	Short blade, 2-1/2" deep x 1" wide (64 x 25 mm)
KM52708S	Short blade, 3" deep x 1" wide (77 x 25 mm)
KM52709S	Short blade, 4" deep x 1" wide (102 x 25 mm)
KM52711S	Short blade, 5" deep x 1" wide (127 x 25 mm)
KM52704L	Long blade, 1-1/4" deep x 1" wide (34 x 25 mm)
KM52705L	Long blade, 2" deep x 1" wide (51 x 25 mm)
KM52706L	Long blade, 2-1/4" deep x 1" wide (57 x 25 mm)
KM52707L	Long blade, 2-1/2" deep x 1" wide (64 x 25 mm)
KM52708L	Long blade, 3" deep x 1" wide (77 x 25 mm)
KM52709L	Long blade, 4" deep x 1" wide (102 x 25 mm)
KM52711L	Long blade, 5" deep x 1" wide (127 x 25 mm)

### SCOVILLE HEMILAMINECTOMY RETRACTOR BODY



ITEM #	DESCRIPTION
KM55445	Spread 6-3/4" (17 cm), arm length 5-1/2" (14 cm)



# ORTHOPEDIC RETRACTORS

Self-Retaining Orthopedic Retractors



## HAVERFIELD-SCOVILLE HEMILAMINECTOMY RETRACTOR BODY



KM55446

ITEM #	DESCRIPTION
KM55446	Body only, 8-3/8" (21.5 cm)

## SCOVILLE-HAVERFIELD RETRACTOR BLADE



KM55455

ITEM #	DESCRIPTION
KM55455	1" x 3-1/2"

## MEYERDING BLADES



KM55459

ITEM #	DESCRIPTION
KM55458	1" wide x 2 1/4" deep (25 x 57 mm)
KM55459	1" wide x 3" deep (25 x 76 mm)
KM55460	2" wide x 3-1/4" deep (51 x 83 mm)







# ORTHOPEDIC RETRACTORS

## Self-Retaining Orthopedic Retractors

### SCOVILLE BLADES

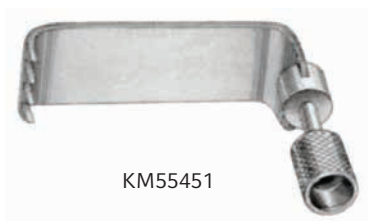

KM55451

Solid.

ITEM #	DESCRIPTION
KM55451	1" wide x 2-1/2" deep (25 mm x 64 mm)
KM55452	2" wide x 2-1/2" deep (51 mm x 64 mm)
KM55453	1-1/8" wide x 2-5/8" deep (29 mm x 67 mm)
KM55454	1" wide x 3-1/2" deep (25 mm x 89 mm)

### HIBBS BLADES



KM55465

ITEM #	DESCRIPTION
KM55461	1" wide x 2" deep (25 x 51 mm)
KM55463	1" wide x 2-1/2" deep (25 x 64 mm)
KM55465	1" wide x 3" deep (25 x 76 mm)
KM55468	1" wide x 4" deep (25 x 102 mm)
KM55464	1-1/2" wide x 2-1/2" deep (38 x 64 mm)
KM55466	1-1/2" wide x 3" deep (38 x 76 mm)
KM55462	2" wide x 2" deep (51 x 51 mm)
KM55467	2" wide x 3" deep (51 x 76 mm)
KM55469	2" wide x 4" deep (51 x 102 mm)

### TAYLOR LAMINECTOMY BLADE



KM55473

ITEM #	DESCRIPTION
KM55473	3 prongs, 1-1/2" wide x 1-3/4" deep (38 x 44 mm)



# ORTHOPEDIC RETRACTORS

## Self-Retaining Orthopedic Retractors



### SCOVILLE BLADES



KM55456

4-prong.

ITEM #	DESCRIPTION
KM55456	1-1/2" wide x 1-5/8" deep (38 x 41 mm)
KM55457	1-7/8" wide x 2-5/8" deep (48 x 67 mm)

### TAYLOR LAMINECTOMY BLADES



KM55474

4-prong.

ITEM #	DESCRIPTION
KM55474	2" wide x 1-7/8" deep (51 x 48 mm)
KM55476	2-1/4" wide x 3-1/8" deep (57 x 79 mm)
KM55475	2-1/2" wide x 2-1/2" deep (64 x 64 mm)

### TAYLOR SPINAL BLADES



KM55472

ITEM #	DESCRIPTION
KM55471	1-1/4" wide x 3" deep (32 x 76 mm)
KM55472	1-1/4" wide x 4" deep (32 x 102 mm)





# ORTHOPEDIC RETRACTORS

## Self-Retaining Orthopedic Retractors

### SCOVILLE BLADES



KM55447

KM55449

Hook style.

ITEM #	DESCRIPTION
KM55447	2" deep (51 mm)
KM55448	3" deep (76 mm)
KM55449	2" deep (51 mm) with cross bar
KM55450	2-3/4" deep (70 mm) with cross bar

### FRAZIER LAMINECTOMY RETRACTOR

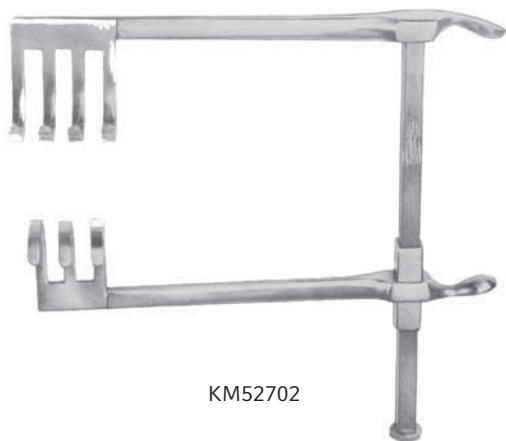

KM52702

ITEM #	DESCRIPTION
KM52702	3 x 4 blunt prongs, spread 3-1/2" (9 cm), arm length 5" (12.5 cm)



# ORTHOPEDIC RETRACTORS

Self-Retaining Orthopedic Retractors

## CRUTCHFIELD TONGS



KM48249

ITEM #	DESCRIPTION
KM48249	With two drills, 4-7/8" (12.5 cm)





# BONE HOLDING INSTRUMENTS

## Bone Holding Forceps

### LEWIN BONE HOLDING FORCEPS



ITEM #	DESCRIPTION
KM47130	Serrated, 7" (18 cm)

### GLENOID PERFORATING FORCEPS

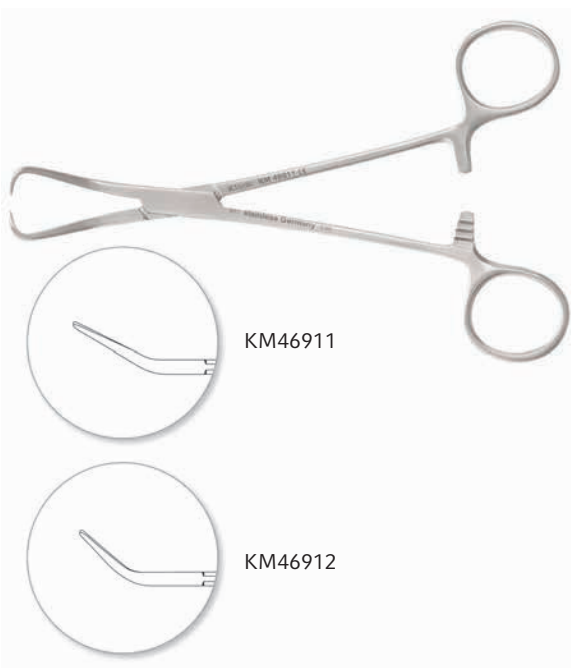

Pointed tips, 6-1/2" (17 cm).

ITEM #	DESCRIPTION
KM46911	Slightly curved
KM46912	Strongly curved



# BONE HOLDING INSTRUMENTS

## Bone Holding Forceps

### BONE HOLDING FORCEPS



For positioning K-Wire up to 0.035" (0.9 mm).

ITEM #	DESCRIPTION
KM45302	Curved, with 0.035" (0.9 mm) K-Wire guide, 6-3/4" (17 cm)

### BONE HOLDING FORCEPS



For positioning K-Wire up to 0.062" (1.6 mm).

ITEM #	DESCRIPTION
KM45304	Curved, with 0.062" (1.6 mm) K-wire guide, 5-1/2" (14 cm)





# BONE HOLDING INSTRUMENTS

## Bone Holding Forceps

### BONE HOLDING FORCEPS



Curved, with K-Wire guide, 5" (13 cm).

ITEM #	DESCRIPTION
KM45305	0.035" (0.9 mm)
KM45306	0.045" (1.1 mm)
KM45307	0.062" (1.6 mm)

### LOCKE PHALANGEAL FORCEPS



Very useful for removing the sesamoid bone.

ITEM #	DESCRIPTION
KM69787	Serrated, 1 x 2 teeth, 6" (15 cm)







# BONE HOLDING INSTRUMENTS

## Bone Holding Forceps

### BONE HOLDING FORCEPS

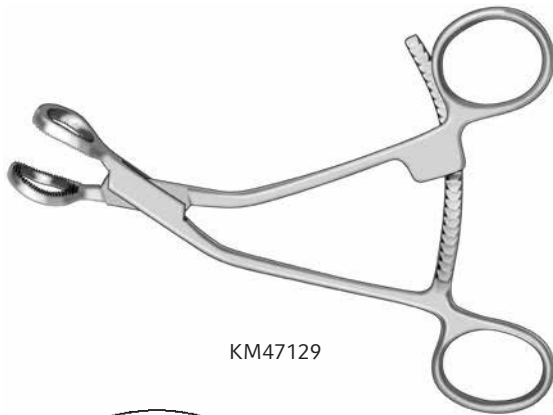

KM47129

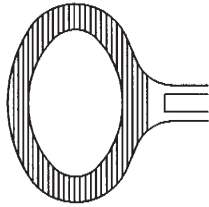
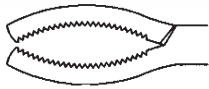

Angled, with fenestration.

ITEM #	DESCRIPTION
KM47129	Inside fenestration 22 x 14 mm, outside fenestration 30 x 20 mm, ratchet length 3" (76 mm), overall length 6" (15 cm)

### MALLEOLLAR BONE HOLDING FORCEPS



KM47010

Grasping forceps for small bones.

ITEM #	DESCRIPTION
KM47010	1 x 1 sharp points, 8-1/4" (21 cm)





# BONE HOLDING INSTRUMENTS

## Bone Holding Forceps

### PARHAM-MARTIN BONE CLAMP



Fit thin end of band through slot in other end of band. Insert thin end into clamp. 8-1/4" (21 cm).

ITEM #	DESCRIPTION
KM47172	Bands not included
KM47173	Single band only

### PLATE AND BONE HOLDING FORCEPS



For positioning small bone plates.

ITEM #	DESCRIPTION
KM47138	5-3/8" (14 cm)





# BONE HOLDING INSTRUMENTS

## Bone Holding Forceps

### PLATE AND BONE HOLDING FORCEPS



KM47139

For positioning mini bone plates.

ITEM #	DESCRIPTION
KM47139	1 pointed tip, 5-1/4" (14 cm)

### SEMB BONE HOLDING FORCEPS

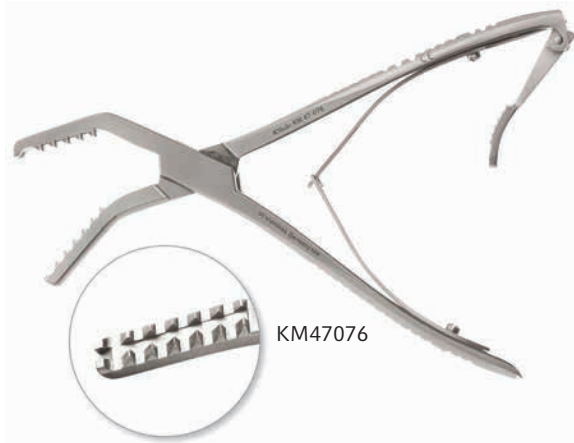

KM47076

Curved sideways. Deep teeth.

ITEM #	DESCRIPTION
KM47074	4 x 5 teeth, without ratchet, 7-1/2" (19 cm)
KM47076	5 x 5 teeth, with ratchet, 8" (21 cm)

### PATELLA BONE HOLDING FORCEPS

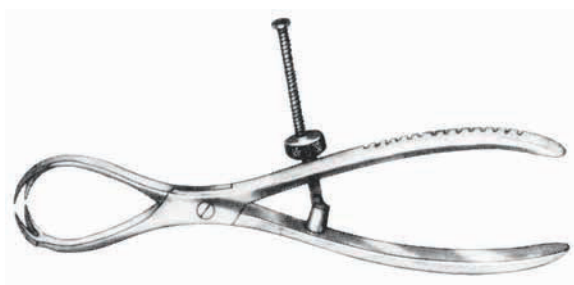

KM47012

ITEM #	DESCRIPTION
KM47012	2 x 2 sharp teeth, with speed lock, 7" (18 cm)





# BONE HOLDING INSTRUMENTS

## Bone Holding Forceps

### VAN BUREN SEQUESTRUM FORCEPS



KM47072

ITEM #	DESCRIPTION
KM47072	Curved sideways, serrated, 9" (23 cm)

### LANGENBECK BONE HOLDING FORCEPS

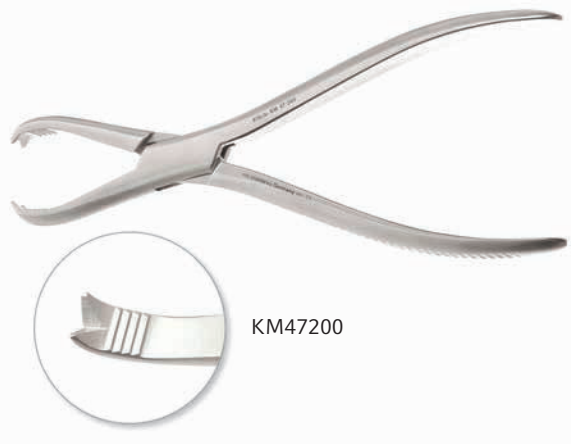

KM47200

ITEM #	DESCRIPTION
KM47200	2 x 2 teeth, 8-1/4" (21 cm)

### FARABEUF BONE HOLDING FORCEPS

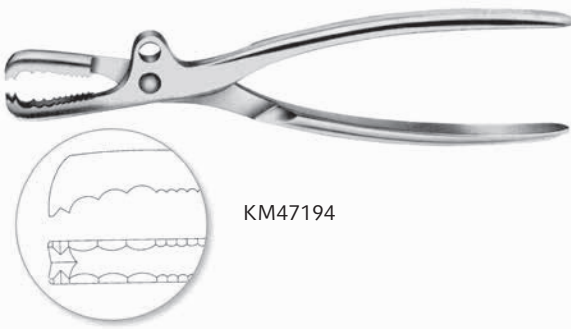

KM47194

Adjustable jaw.

ITEM #	DESCRIPTION
KM47194	9" (23 cm)
KM47196	10" (25.5 cm)



# BONE HOLDING INSTRUMENTS

## Bone Holding Forceps

### FARABEUFLAMBOTTE BONE HOLDING FORCEPS



KM47190

Adjustable jaw.

ITEM #	DESCRIPTION
KM47190	7-1/2" (19 cm)
KM47192	10-1/2" (27 cm)

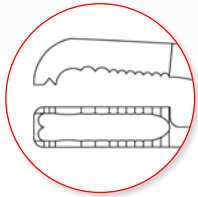

KM47190

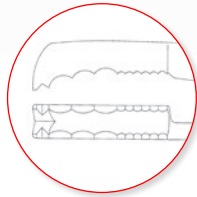

KM47192

### FERGUSSON BONE HOLDING FORCEPS



KM47198

ITEM #	DESCRIPTION
KM47198	Deep teeth, 8-1/4" (21 cm)

### FIBULA BONE HOLDING FORCEPS

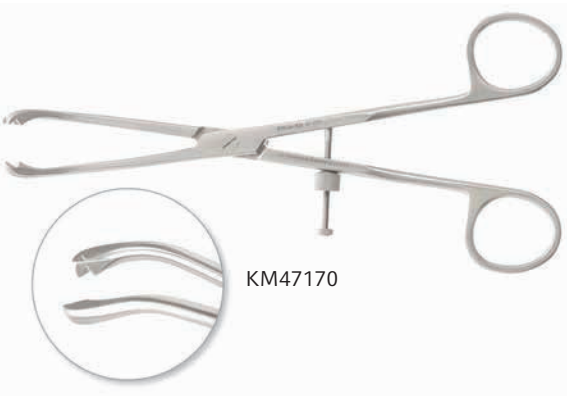

KM47170

With angled tip and speed lock.

ITEM #	DESCRIPTION
KM47170	8-1/2" (22 cm)





# BONE HOLDING INSTRUMENTS

## Bone Holding Forceps

### KERN BONE HOLDING FORCEPS

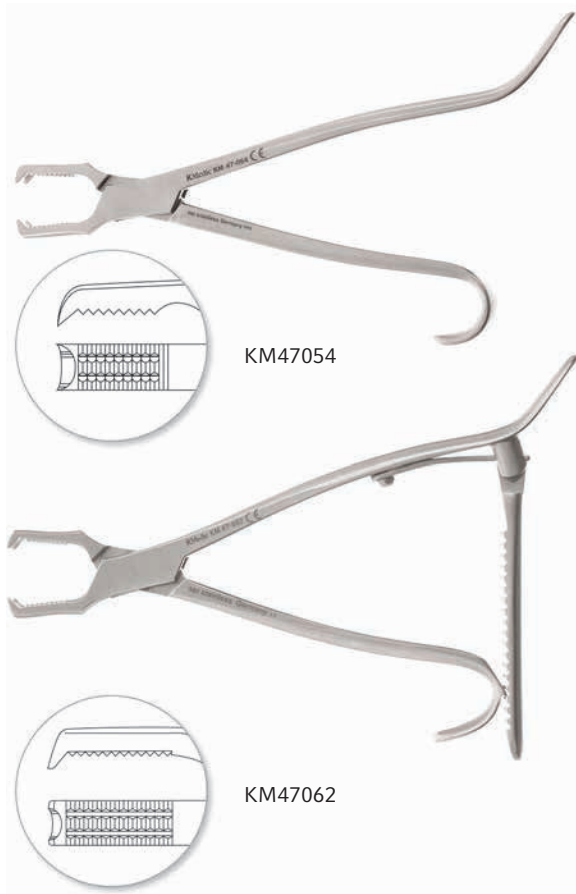

ITEM #	DESCRIPTION
KM47054	Mini, 6-5/8" (17 cm), without ratchet
KM47056	9-1/2" (24 cm), without ratchet
KM47062	6-3/4" (17 cm), with ratchet
KM47064	9-1/2" (24 cm), with ratchet

### LAMBOTTE BONE HOLDING FORCEPS



With swivel head, adjustable jaw.

ITEM #	DESCRIPTION
KM47204	8-1/2" (22 cm)
KM47206	10-1/2" (27 cm)
KM47208	11-1/2" (29 cm)



# BONE HOLDING INSTRUMENTS

## Bone Holding Forceps

### LANE BONE HOLDING FORCEPS

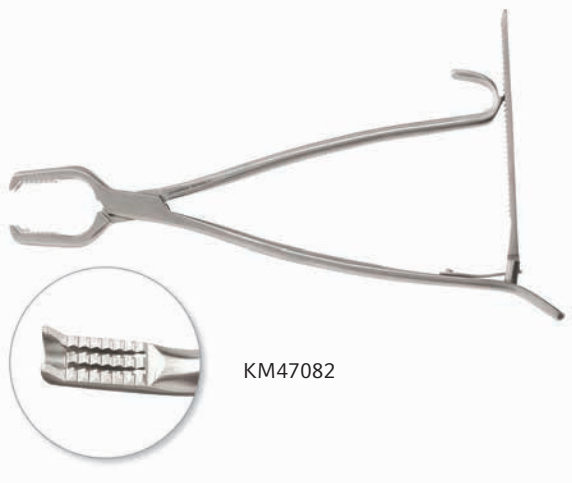

Particularly well suited for use during insertion of intermedullary nails.

ITEM #	DESCRIPTION
KM47078	Light model, without ratchet, 13" (33 cm)
KM47080	Light model, with ratchet, 13" (33 cm)
KM47068	Standard model, without ratchet, 13" (33 cm)
KM47082	Standard model, with ratchet, 13" (33 cm)
KM47070	Without ratchet, 17" (43 cm)
KM47084	With ratchet, 17" (43 cm)

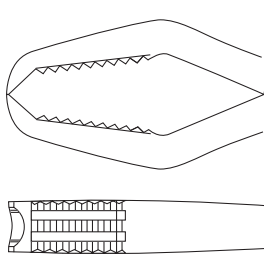

KM47078  
KM47080

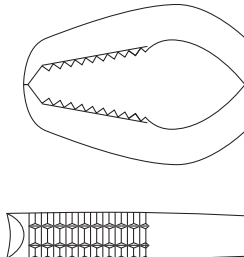

KM47068  
KM47082

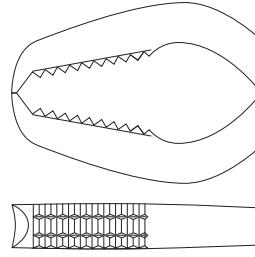

KM47070  
KM47084







# BONE HOLDING INSTRUMENTS

## Bone Holding Forceps

### ULRICH SELF-RETAINING BONE HOLDING FORCEPS



KM47108

Straight, with speed lock.

ITEM #	DESCRIPTION
KM47108	Mini, 7-1/4" (19 cm)
KM47110	8-1/2" (22 cm)
KM47112	9-7/8" (25 cm)
KM47114	10-1/4" (26 cm)



KM47108

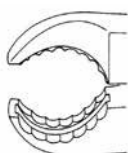

KM47110

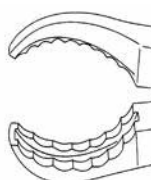

KM47112



KM47114

### ULRICH SELF-RETAINING BONE HOLDING FORCEPS



KM47116

Angled, with speed lock.

ITEM #	DESCRIPTION
KM47109	7-1/4" (19 cm)
KM47116	11" (28 cm)



# BONE HOLDING INSTRUMENTS

## Bone Holding Forceps

### ULRICH SELF-RETAINING BONE HOLDING FORCEPS

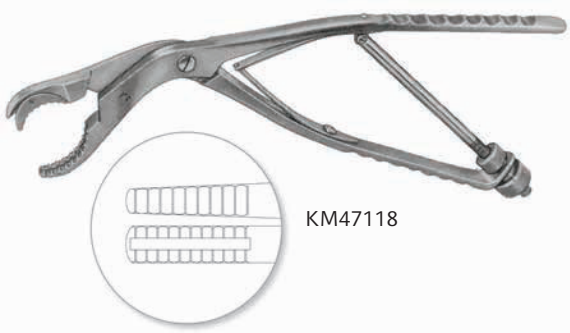

Angled, with speed lock and swivel jaw.

ITEM #	DESCRIPTION
KM47118	11" (28 cm)

### ANGLED BONE HOLDING FORCEPS



With swivel head, adjustable jaw.

ITEM #	DESCRIPTION
KM47212	8-1/2" (22 cm)





# BONE HOLDING INSTRUMENTS

## Bone Holding Forceps

### VEBRUGGE SELF-CENTERING BONE HOLDING FORCEPS



Self centering, with speed lock.

ITEM #	DESCRIPTION
KM47090	5-3/4" (15 cm)
KM47092	7-1/4" (19 cm)
KM47094	9-1/4" (24 cm)
KM47096	10" (26 cm)
KM47098	11-1/4" (29 cm)



### VERBRUEGGE BONE HOLDING FORCEPS



With short ratchet.

ITEM #	DESCRIPTION
KM47120	6-7/8" (18 cm)





# BONE HOLDING INSTRUMENTS

## Bone Holding Forceps

### VERBRUEGGE BONE HOLDING FORCEPS

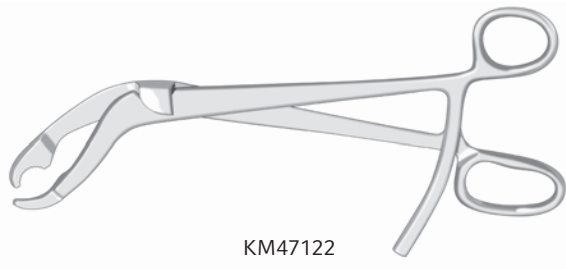

With long ratchet.

ITEM #	DESCRIPTION
KM47122	10" (26 cm)
KM47124	10-1/2" (27 cm)
KM47126	11" (28 cm)



## Bone Reduction Forceps

### STAGBEETLE BONE REDUCTION FORCEPS

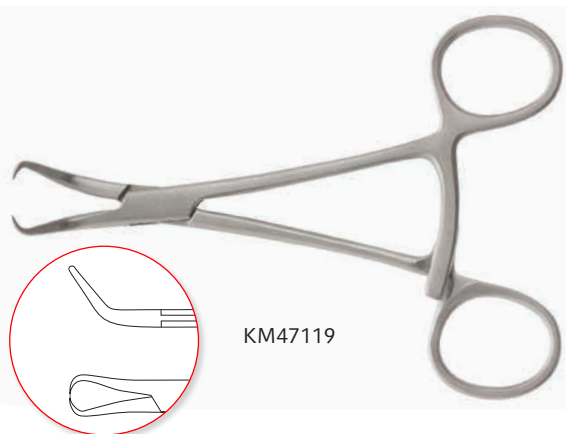

ITEM #	DESCRIPTION
KM47119	Curved, pointed tips, 4-7/8" (13 cm)



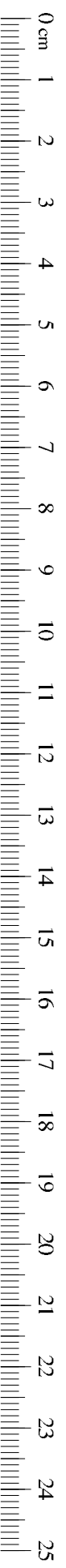

# BONE HOLDING INSTRUMENTS

## Bone Reduction Forceps

### REILL BONE REDUCTION FORCEPS

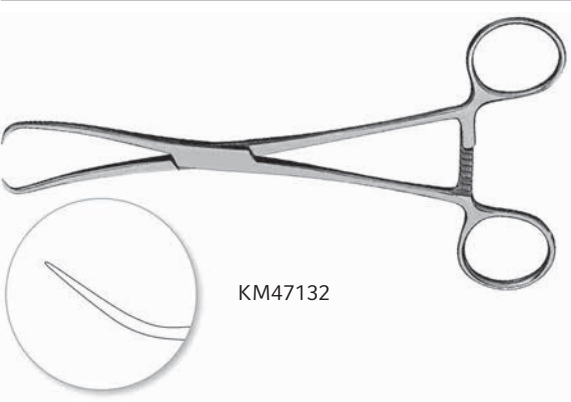

KM47132

ITEM #	DESCRIPTION
KM47132	Curved, pointed tips, 6-3/4" (17 cm)

### BONE REDUCTION FORCEPS

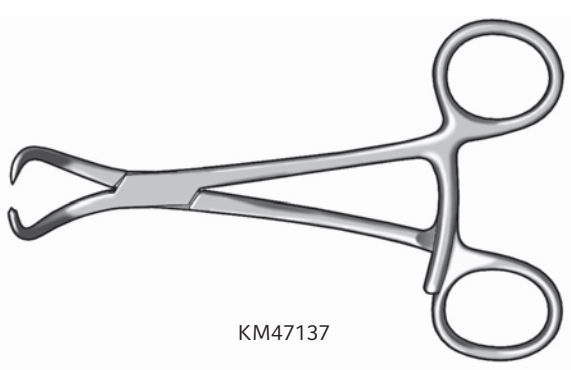

KM47137

Curved. One tip has a stepped point for a better hold on bone.

ITEM #	DESCRIPTION
KM47137	5-1/4" (14 cm)
KM47136	6-3/4" (17 cm)

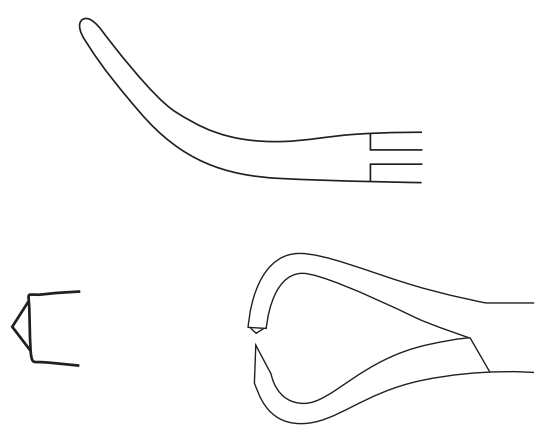



# BONE HOLDING INSTRUMENTS

## Bone Reduction Forceps

### BONE REDUCTION FORCEPS

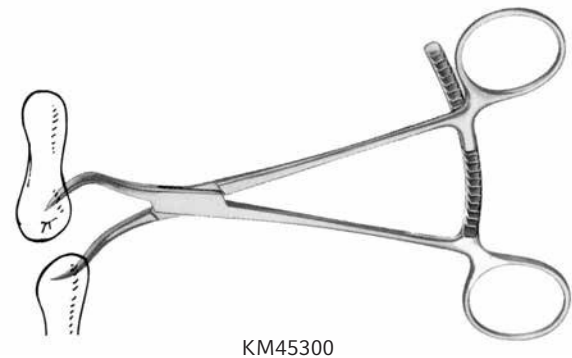

KM45300

ITEM #	DESCRIPTION
KM45300	Curved, pointed tips, 5" (13 cm)

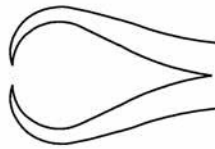

### BONE REDUCTION FORCEPS



KM47134

With ratchet completely engaged, the jaw opening is 9 mm wide.

ITEM #	DESCRIPTION
KM47134	Ratchet length: 2" (5 cm) Opens to 4" (10 cm) 8" (21 cm)



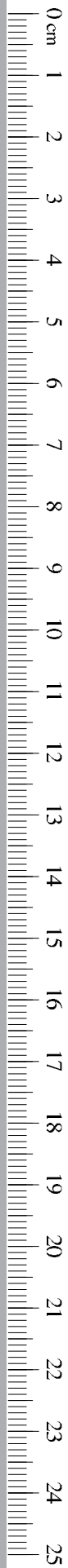

# BONE HOLDING INSTRUMENTS

## Bone Reduction Forceps

### BONE REDUCTION FORCEPS

Curved and serrated with pointed tips.



ITEM #	DESCRIPTION
KM47133	Narrow, 5-1/4" (14 cm)
KM47135	Broad, 5-1/2" (14 cm)





# BONE HOLDING INSTRUMENTS

## Bone Reduction Forceps

### BONE REDUCTION FORCEPS



Curved, with speed lock.

ITEM #	DESCRIPTION
KM47105	7" (18 cm)
KM47107	9-5/8" (25 cm)

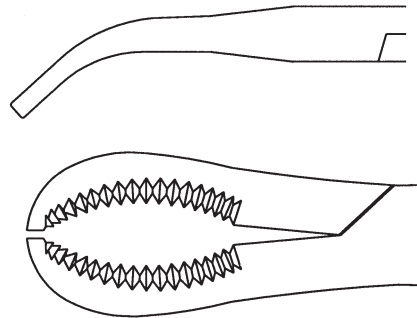

### BONE REDUCTION FORCEPS



ITEM #	DESCRIPTION
KM47128	Small, curved, ratchet length 1-1/8" (28 mm), 5-1/2" (14 cm)

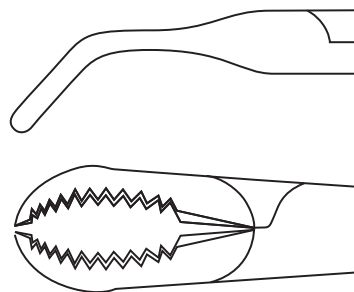



# BONE HOLDING INSTRUMENTS

## Bone Reduction Forceps

### ANGLED PELVIC BONE REDUCTION FORCEPS

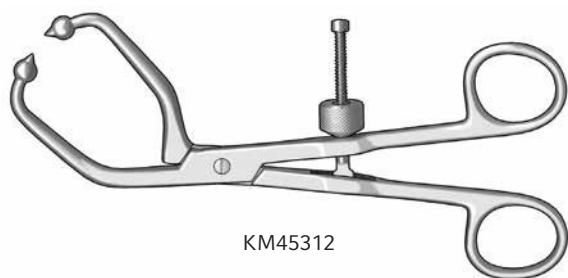

Short tips.

ITEM #	DESCRIPTION
KM45312	Short pointed-ball tips, 7-3/8" (19 cm)

### ANGLED PELVIC BONE REDUCTION FORCEPS

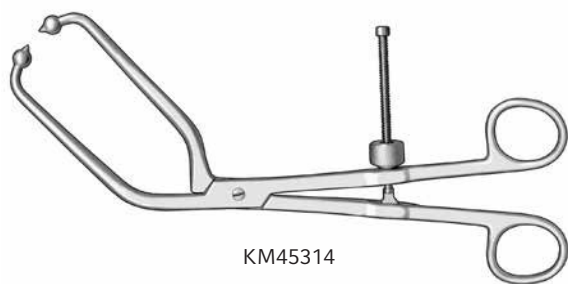

Long tips.

ITEM #	DESCRIPTION
KM45314	Long pointed-ball tips, 9-5/8" (25 cm)

### ASYMETRIC PELVIC REDUCTION FORCEPS



ITEM #	DESCRIPTION
KM45310	Short pointed-ball tips, 16" (41 cm)

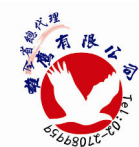

# BONE HOLDING INSTRUMENTS

## Bone Reduction Forceps

### PELVIC REDUCTION FORCEPS



KM47100

ITEM #	DESCRIPTION
KM47100	With screws, 13-1/2" (35 cm)

### PELVIC REDUCTION FORCEPS

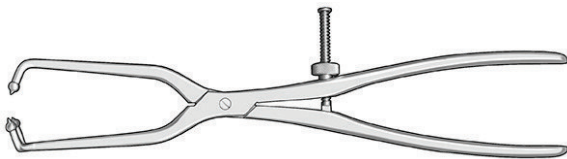

KM47101

ITEM #	DESCRIPTION
KM47101	1 x 2 jaws, long pointed-ball tips, 16-1/8" (41 cm)



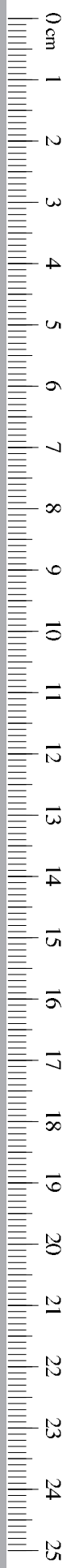

# BONE HOLDING INSTRUMENTS

## Bone Reduction Forceps

### PELVIC REDUCTION FORCEPS

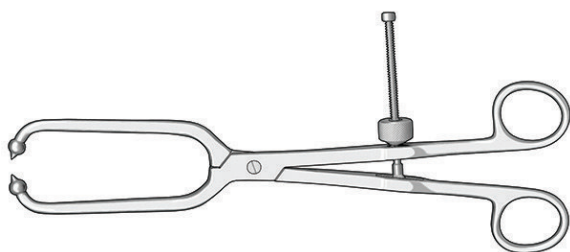

KM47102

ITEM #	DESCRIPTION
KM47102	Angled tips, short pointed-ball tips, 10-1/8" (26 cm)

### PELVIC REDUCTION FORCEPS

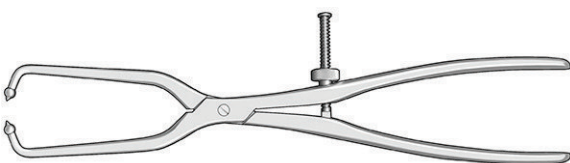

KM47103

ITEM #	DESCRIPTION
KM47103	Pointed tips, long pointed-ball tips, 16-1/8" (41 cm)





# BONE HOLDING INSTRUMENTS

## Bone Clamps

### BISHOP BONE CLAMP



ITEM #	DESCRIPTION
KM47202	Adjustable jaw, 8-7/8" (22.5 cm)

### LAMBERT-LOWMAN BONE CLAMPS

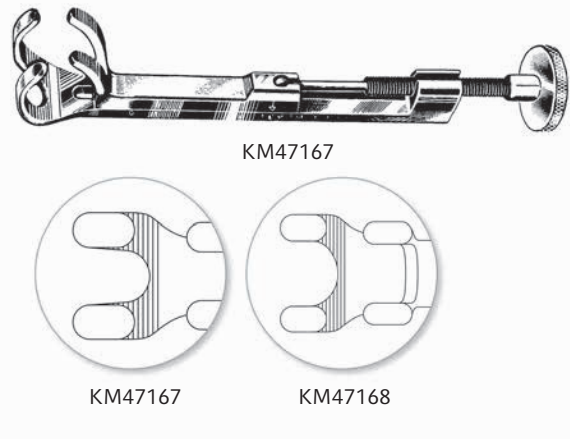

2 x 2 jaws. Calibrated in inches to measure bone diameter.

ITEM #	DESCRIPTION
KM47167	7-1/4" (18.5 cm)
KM47168	8" (20.5 cm)

### LOWMAN BONE CLAMPS

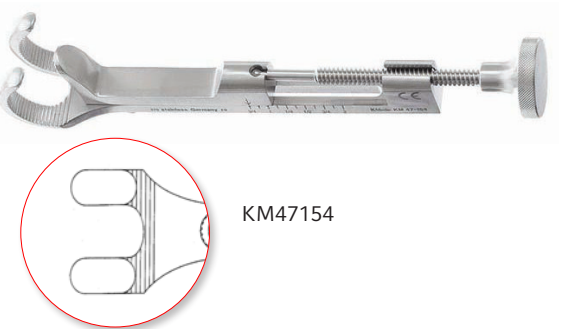

1 x 2 jaws. Calibrated in inches to measure bone diameter.

ITEM #	DESCRIPTION
KM47140	4-3/4" (12 cm)
KM47154	5-5/8" (14.5 cm)
KM47156	6-3/4" (17 cm)





# BONE HOLDING INSTRUMENTS

## Bone Clamps

### LOWMAN BONE CLAMPS

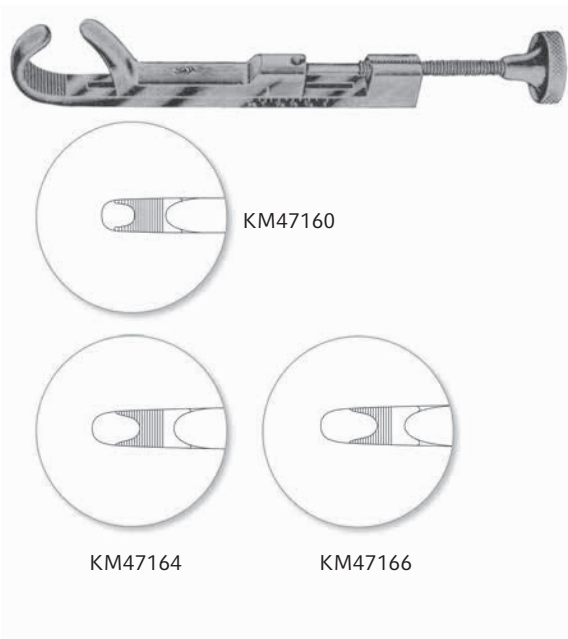

1 x 1 jaws. Calibrated in inches to measure bone diameter.

ITEM #	DESCRIPTION
KM47160	4-3/4" (12 cm)
KM47164	5-3/4" (14.5 cm)
KM47166	6-7/8" (17.5 cm)

### ROSENBLOOM SESAMOID CLAMP

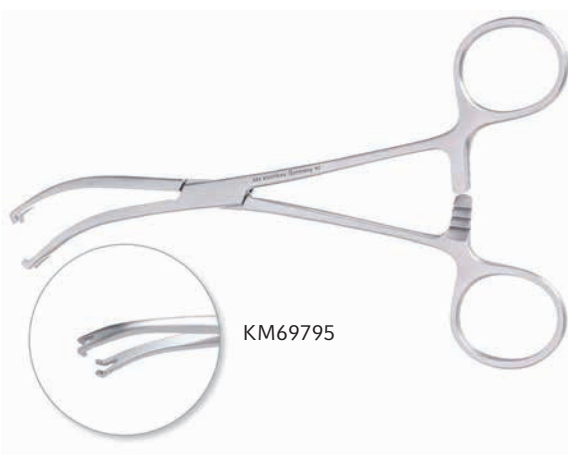

ITEM #	DESCRIPTION
KM69795	Slightly curved, 6-1/2" (16.5 cm)



# BONE HOLDING INSTRUMENTS

## Bone Clamps

### VOGEN SESAMOID CLAMP

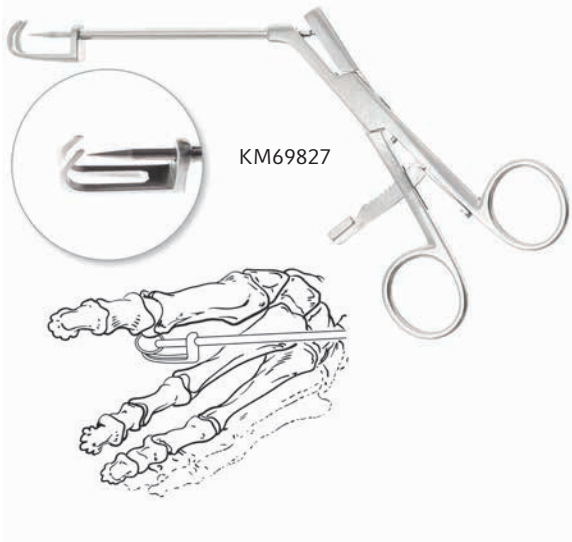

- Designed to grasp and hold a sesamoid while dissecting it free.
- The sesamoid is first exposed within the capsule, then the two-pronged tip is hooked beneath the sesamoid. The plunger is then seated in the bone to secure it for manipulation and dissection.

ITEM #	DESCRIPTION
KM69827	4" (10 cm) shaft





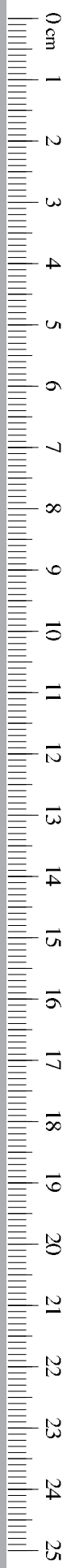

# BONE HOOKS AND AWLS

## Bone Hooks

### SHARP HOOK



KM47880

To check fracture and remove ingrown tissue.

ITEM #	DESCRIPTION
KM47880	6" (15 cm)

### BONE HOOKS



KM48343

Sharp with grip handle, 9" (23 cm).



KM48344

ITEM #	DESCRIPTION
KM48342	Small, 6 mm high x 10 mm deep
KM48343	Medium, 11 mm high x 18 mm deep
KM48344	Large, 12 mm high x 21 mm deep

### VOLKMAN BONE HOOKS



KM48331

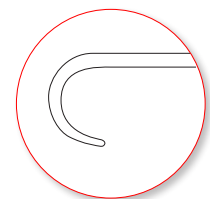
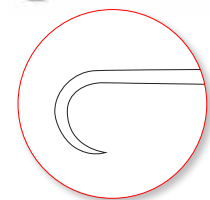

KM48333

ITEM #	DESCRIPTION
KM48331	Sharp, 15 mm high x 20 mm deep, 9" (23 cm)
KM48335	Sharp, 15 mm high x 20 mm deep, 9-3/4" (25 cm)
KM48334	Sharp, 19 mm high x 27 mm deep, 8-5/8" (22 cm)
KM48333	Blunt, 15 mm high x 20 mm deep, 9" (23 cm)





# BONE HOOKS AND AWLS

## Bone Hooks

### BONE HOOK



Large, for femurs. With T-handle.

ITEM #	DESCRIPTION
KM48332	18 mm high x 21 mm deep, 7-7/8" (20 cm)

## Awls

### BONE AWL

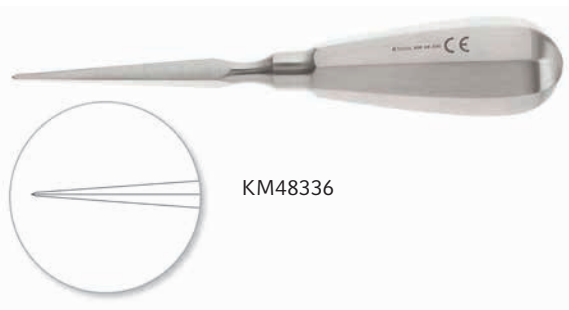

ITEM #	DESCRIPTION
KM48336	Square taper, 6-1/4" (16 cm)

### KUNTSCHER DIAMOND POINTED AWL



ITEM #	DESCRIPTION
KM48303	With handle, 11-5/8" (29.5 cm)

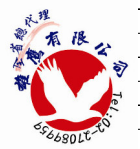



# BONE HOOKS AND AWLS

## Awls

### PERTHES BONE AWL



KM48337

ITEM #	DESCRIPTION
KM48337	8-1/4" (21 cm)

### RUSH AWL AND REAMERS

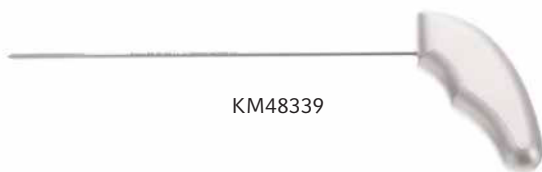

KM48339

For penetrating cortex of bone. Used as grooved director for insertion of pins.

ITEM #	DESCRIPTION
KM48338	0.1" (2.5 mm) diameter, working length 7-1/2" (19 cm), pointed, 9-7/8" (25 cm)
KM48339	0.1" (3 mm) diameter, working length 8-1/4" (21 cm), pointed, 10-5/8" (27 cm)
KM48340	0.2" (5 mm) diameter, working length 8-1/2" (21.5 cm), pointed, 10-7/8" (27.5 cm)
KM48341	0.25" (6 mm) diameter, working length 10-1/2" (26.5 cm), pointed, 12-3/4" (32.5 cm)

### SHOULDER PENETRATING AWL



KM46916

Phenolic handle.

ITEM #	DESCRIPTION
KM46916	9-1/4" (23.5 cm)

Autoclavable to 290°F (143°C)





# BONE HOOKS AND AWLS

## Awls

### SHOULDER PERCUSSION AWLS

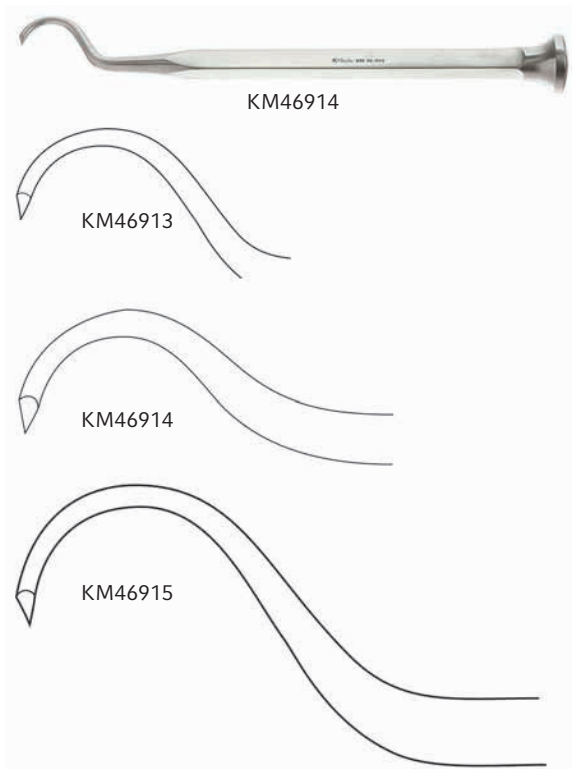

8-1/2" (21.5 cm).

ITEM #	DESCRIPTION
KM46913	Small
KM46914	Medium
KM46915	Large





# CARTILAGE AND TENDON INSTRUMENTS

## Clamps and Forceps

### MARTIN CARTILAGE CLAMPS



Deep teeth.

ITEM #	DESCRIPTION
KM46802	7-3/8" (18.5 cm)
KM46814	8-1/8" (20.5 cm)

### WALTON CARTILAGE CLAMP



ITEM #	DESCRIPTION
KM46818	Slightly curved, 8-1/2" (21.5 cm)





# CARTILAGE AND TENDON INSTRUMENTS

## Clamps and Forceps

### DINGMAN FORCEPS



ITEM #	DESCRIPTION
KM46804	Angular, 2 x 2 sharp teeth, serrated jaws, 7-1/2" (19 cm)

KM46804

### MENISCUS CLAMP



ITEM #	DESCRIPTION
KM46750	Curved shaft, 7-1/8" (18 cm)

KM46750





# CARTILAGE AND TENDON INSTRUMENTS

## Clamps and Forceps

### MENISCUS CLAMPS



KM46744

Serrated, 5-3/8" (13.5 cm).

ITEM #	DESCRIPTION
KM46744	Straight
KM46746	Angled 20 degrees



KM46746

### PRESTON LIGAMENTUM FLAVUM FORCEPS (MENISCUS)



KM46748

For grasping tags of the meniscus.

ITEM #	DESCRIPTION
KM46748	Serrated jaw with 1 x 2 tip, 7-1/4" (19 cm)

### HOEN ALLIGATOR FORCEPS



KM55170

For retrieving tendons or foreign bodies.

ITEM #	DESCRIPTION
KM55170	Serrated jaw with 1 x 2 tip, 5-7/8" (15 cm) shaft





# CARTILAGE AND TENDON INSTRUMENTS

## Clamps and Forceps

### KLEINERT-KUTZ TENDON RETRIEVERS

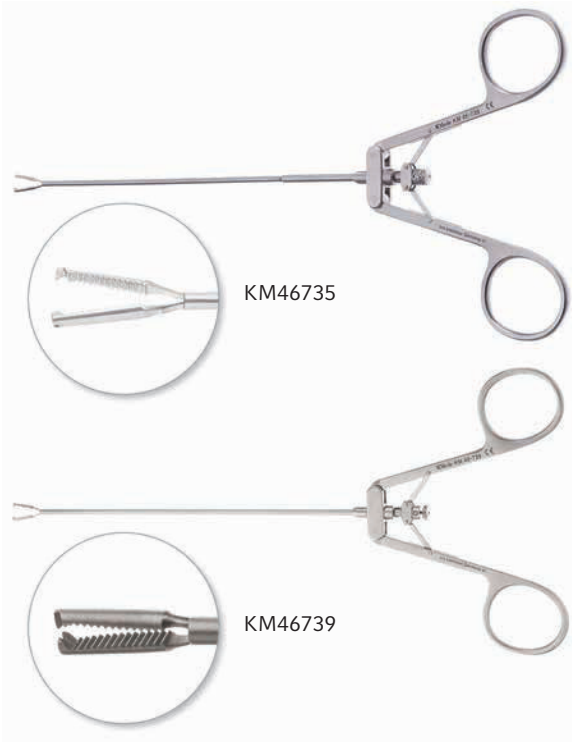

Serrated with sharp teeth, 8" (20.5 cm).

ITEM #	DESCRIPTION
KM46735	Flexible shaft
KM46739	Rigid shaft

### CARROLL TENDON RETRIEVER



ITEM #	DESCRIPTION
065325	Curved shaft, 6" (15 cm)





# CARTILAGE AND TENDON INSTRUMENTS

## Clamps and Forceps

### BRAND TENDON PULLING FORCEPS



Angular shaft.

ITEM #	DESCRIPTION
KM46736	6" (15 cm)
KM46737	7-1/2" (19 cm)
KM46738	9-1/2" (24 cm)

## Cartilage Knives

### DOWNING CARTILAGE KNIFE



ITEM #	DESCRIPTION
KM46772	Curved blade, concave edge. With guards, 10" (25.5 cm)

### SMILLIE KNIVES

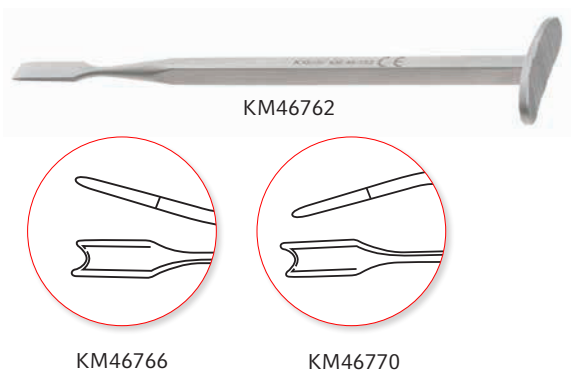

Also known as a meniscus knife. Useful for fasciotomies, 6-1/4" (16 cm).

ITEM #	DESCRIPTION
KM46762	Straight, chisel type
KM46766	Curved left
KM46770	Curved right





# CARTILAGE AND TENDON INSTRUMENTS

## Cartilage Scissors

### MARTIN CARTILAGE SCISSORS



ITEM #	DESCRIPTION
790320	Curved, two serrated blades, 8" (20.5 cm)
KM46828	Two serrated blades, 8" (20.5 cm)

### MUELLER CAPSULE SCISSORS



ITEM #	DESCRIPTION
KM46821	Angled, 9-1/2" (24 cm)



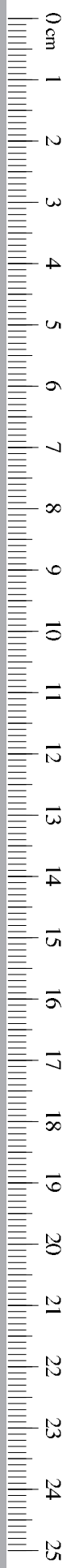

# CARTILAGE AND TENDON INSTRUMENTS

## Tendon Strippers

### BUNNELL TENDON STRIPPERS



6" (15 cm).

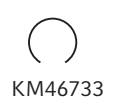
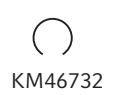
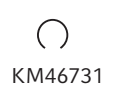
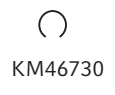

ITEM #	DESCRIPTION
KM46730	3 mm
KM46731	4 mm
KM46732	5 mm
KM46733	6 mm
KM46734	7 mm

*Note gaps in circles are accurate.*





# DISSECTORS AND ELEVATORS

## SMITHWICK HOOK AND DISSECTOR



KM49320

ITEM #	DESCRIPTION
KM49320	Double-ended, 12" (30.5 cm)

## WOODSON DURAL SEPARATOR AND PACKER



KM55302

ITEM #	DESCRIPTION
KM55302	Double-ended with grooved blade, 3 mm blunt end, 7" (18 cm)

## WOODSON ELEVATOR AND SPATULA



KM55300

ITEM #	DESCRIPTION
KM55300	Double-end, semi-sharp, angled, both ends 3 mm, 10" (25.5 cm)

## RHOTON BALL-TIPPED DISSECTORS



KM55346

7-1/2" (19 cm).

ITEM #	DESCRIPTION
KM55344	Straight, 0.8 mm
KM55345	Angled 90 degrees, 3 mm
KM55346	Angled 90 degrees, 5 mm
KM55347	Angled 40 degrees, 4 mm
KM55348	Angled 40 degrees, 8 mm

## RHOTON ELEVATORS



KM55333

7-1/2" (19 cm).

ITEM #	DESCRIPTION
KM55333	Curved
KM55334	Angled



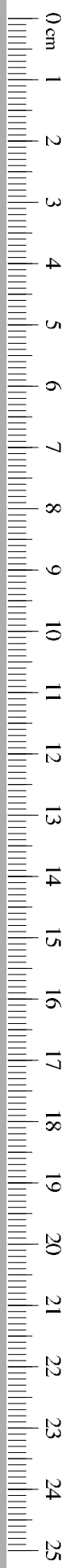

# DISSECTORS AND ELEVATORS

## RHOTON MICRO CURETTES



7-1/2" (19 cm).

ITEM #	DESCRIPTION
KM55342	Straight, 1 x 2 mm
KM55343	Angled, 1 x 2 mm

## RHOTON MICRO DISSECTION HOOKS

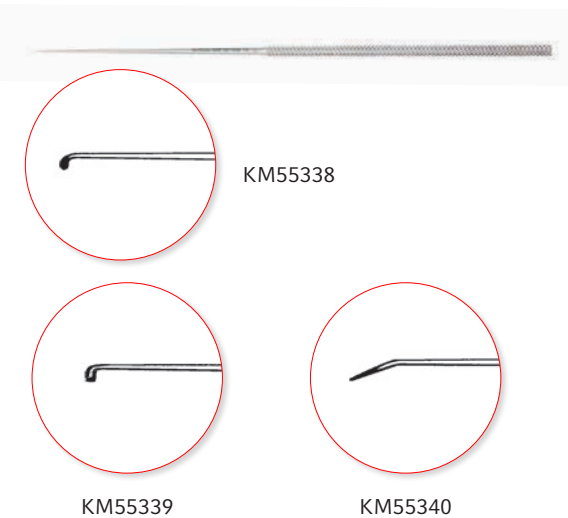

ITEM #	DESCRIPTION
KM55338	Sharp, angled 90 degrees
KM55339	Blunt, angled 90 degrees
KM55340	Sharp, angled 45 degrees

## RHOTON NEEDLE SHARP



ITEM #	DESCRIPTION
KM55341	Straight, sharp





# DISSECTORS AND ELEVATORS

## RHOTON ROUND DISSECTORS



ITEM #	DESCRIPTION
KM55330	Angled, 1 mm
KM55331	Angled, 2 mm
KM55332	Angled, 3 mm

## RHOTON SPATULA DISSECTORS



ITEM #	DESCRIPTION
KM55335	#6 Small, angled
KM55336	#7 Medium, angled
KM55337	#8 Large, angled





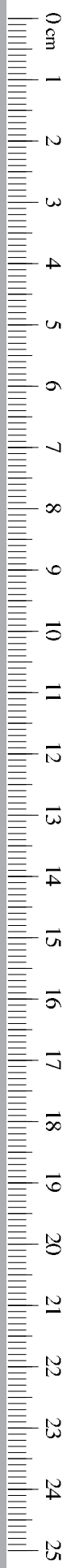

# DISSECTORS AND ELEVATORS

## Penfield Elevators/Dissectors

### PENFIELD ELEVATORS



ITEM #	DESCRIPTION
KM57624	Style #1, double-ended, 7" (18 cm)
KM57626	Style #2, double-ended, 7-3/4" (19.5 cm)
KM57628	Style #3, double-ended, 7-3/4" (19.5 cm)
KM57630	Style #4, single-ended, 8" (20.5 cm)
KM57632	Style #5, double-ended, 7-1/2" (19 cm)

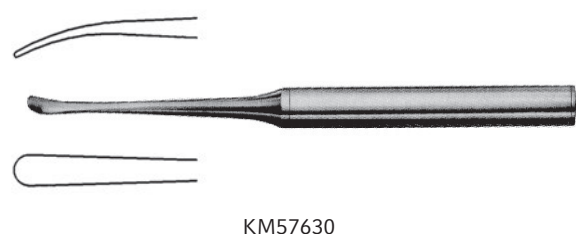
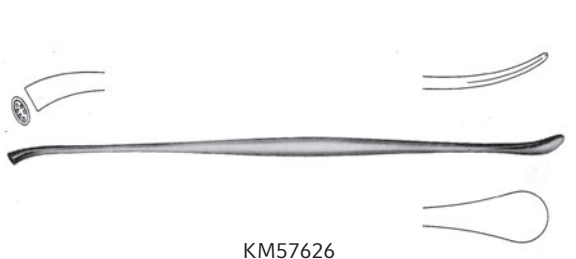



# DISSECTORS AND ELEVATORS

## Double-Ended Elevators

### ALLERDYCE ELEVATOR AND DISSECTOR



KM57616

ITEM #	DESCRIPTION
KM57616	Double-ended, 8 mm semi-sharp end, 8 mm blunt end, 7-1/2" (19 cm)

### FREER DOUBLE-END ELEVATOR



355194

Pilling® Pattern, satin finish.

ITEM #	DESCRIPTION
355194	Double-ended, sharp and blunt, 7" (18 cm)

### FREER DOUBLE-END ELEVATOR



KM57614

KMedic® Pattern, satin finish.

ITEM #	DESCRIPTION
KM57614	Double-ended, 5 mm sharp and 5 mm blunt ends, 7-1/4" (18.5 cm)

### KLEINERT-KUTZ ELEVATOR AND DISSECTOR



KM57615

ITEM #	DESCRIPTION
KM57615	Double-ended, 2 mm and 3 mm sharp ends, 7-5/8" (19.5 cm)

### KLEINERT-KUTZ ELEVATOR AND DISSECTOR



065300

ITEM #	DESCRIPTION
065300	Double-ended, 2.4 mm and 3.2 mm ends, 7-3/4" (19.5 cm)



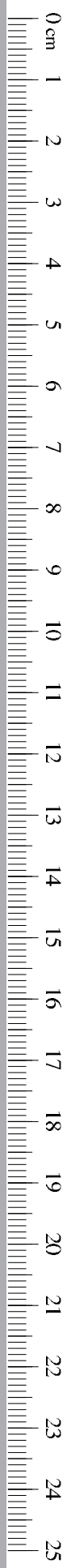

# DISSECTORS AND ELEVATORS

## Metatarsal Elevators

### MCGLAMERY® METATARSAL ELEVATOR



KM69758

ITEM #	DESCRIPTION
KM69758	Sharp, curved, 9 mm, 6-1/2" (16.5 cm)

### MCGLAMERY® METATARSAL ELEVATORS



KM69764

For foot surgeons, the McGlamry® Elevator is indispensable. It's the perfect tool to deglove a metatarsal head, and it's invaluable in numerous other procedures. Sharp edge, 6-1/2" (16.5 cm).



ITEM #	DESCRIPTION
KM69760	11 mm
KM69762	13 mm
KM69764	15 mm
KM69766	17 mm



KM69760



KM69762



KM69764



KM69766

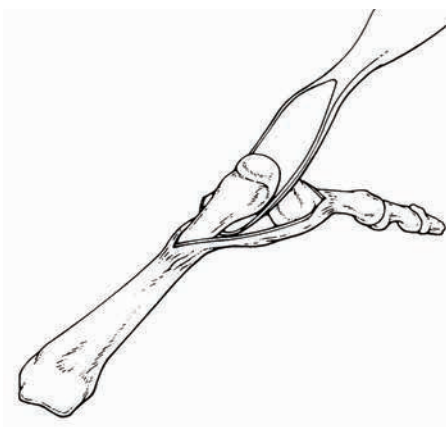

# DISSECTORS AND ELEVATORS

## Periosteal Elevators

### COTTLE DOUBLE-ENDED ELEVATOR



Graduated in 10 mm increments.

ITEM #	DESCRIPTION
053135	Blade A 5 mm Blade B 3 mm 8-7/8" (22.5 cm)

### MCKENTY ELEVATORS

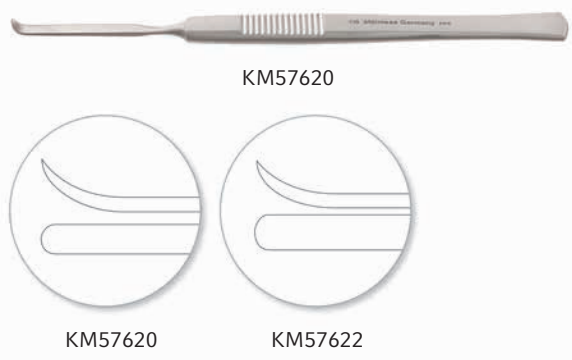

Semi-sharp, 5-1/2" (14 cm).

ITEM #	DESCRIPTION
KM57620	4 mm
KM57622	5 mm





# DISSECTORS AND ELEVATORS

## Periosteal Elevators

### KEY PERIOSTEAL ELEVATORS



KM46262

Sharp edge.

ITEM #	DESCRIPTION
KM46258	1/4" (6.4 mm) wide, 7" (17.5 cm)
KM46260	3/8" (9.5 mm) wide, 7-1/2" (19 cm)
KM46262	1/2" (13 mm) wide, 7-1/2" (19 cm)
KM46264	3/4" (19 mm) wide, 7-7/8" (20 cm)
KM46266	1" (25.4 mm) wide, 8-3/8" (21.5 cm)

### KEY PERIOSTEAL ELEVATOR



586250

ITEM #	DESCRIPTION
586250	1/8" (3 mm) jaw, 7" (18 cm)

### ADSON PERIOSTEAL ELEVATORS



KM49310

Also known as Joseph Elevator, 7 mm, 6-3/4" (17 cm).

ITEM #	DESCRIPTION
KM49310	Sharp, straight
KM49311	Blunt, curved
KM49313	Semi-sharp, straight
KM49312	Semi-sharp, curved

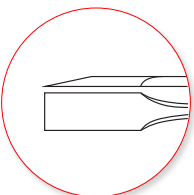

KM49310

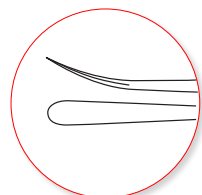

KM49311

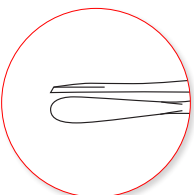

KM49313

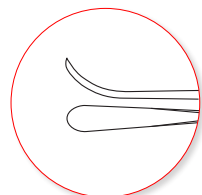

KM49312



# DISSECTORS AND ELEVATORS

## Periosteal Elevators

### CUSHING LITTLE JOKER ELEVATOR



358350

ITEM #	DESCRIPTION
358350	8 mm tip, 6-5/8" (16.5 cm)

### CUSHING PERIOSTEAL ELEVATORS



KM49322

7-1/2" (19 cm).

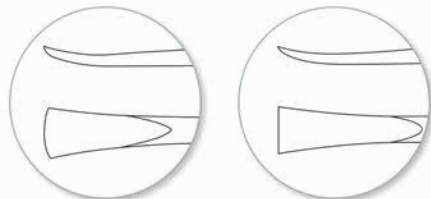

KM49322

KM49324

ITEM #	DESCRIPTION
KM49322	15 mm sharp, curved edge
KM49324	15 mm sharp, straight edge
KM49326	15 mm, Serrated, curved edge



KM49326

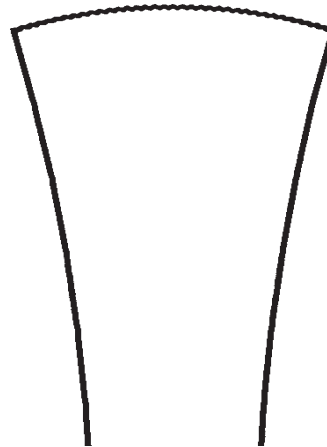

KM49326





# DISSECTORS AND ELEVATORS

## Periosteal Elevators

### CREGO PERIOSTEAL ELEVATOR

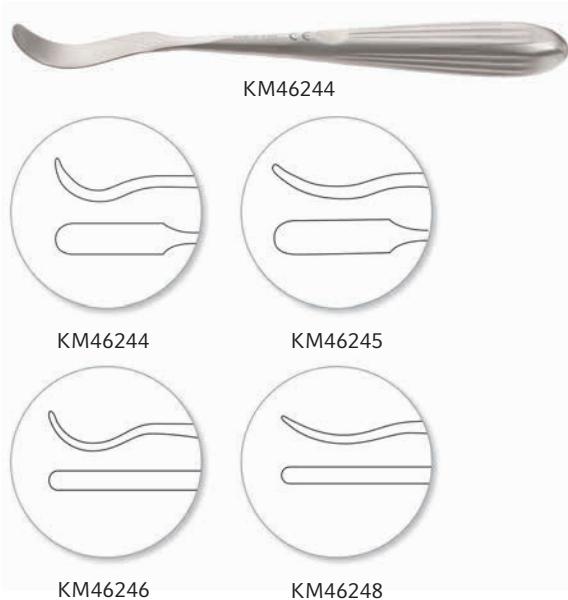

ITEM #	DESCRIPTION
KM46244	Blunt, full curved, 15 mm, 7-3/8" (18.5 cm)
KM46245	Sharp, slightly curved, 15 mm, 7-3/4" (19.5 cm)
KM46246	Sharp, full curved, 7 mm, 7-3/4" (19.5 cm)
KM46248	Sharp, slightly curved, 7 mm, 8" (20.5 cm)

### LANE PERIOSTEAL ELEVATOR

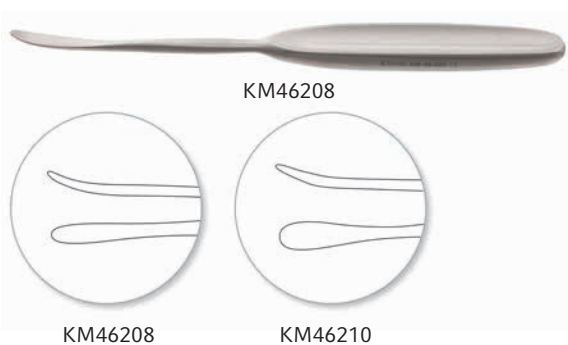

Blunt, 7-3/4" (19.5 cm).

ITEM #	DESCRIPTION
KM46208	Narrow, 6 mm
KM46210	Broad, 10 mm

### LANGENBECK PERIOSTEAL ELEVATOR

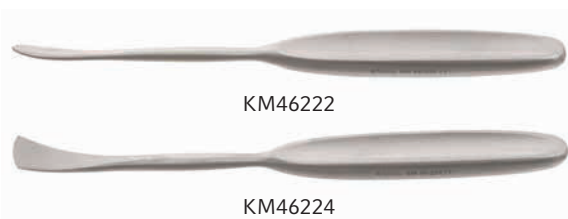

7-3/4" (19.5 cm)

ITEM #	DESCRIPTION
KM46222	Narrow, 6 mm, blunt edge
KM46224	Broad, 17 mm, sharp edge





0 in

1

2

3

4

5

6

7

8

# DISSECTORS AND ELEVATORS

## Periosteal Elevators

### SEDILLOT PERIOSTEAL ELEVATOR



KM58085

ITEM #	DESCRIPTION
KM58085	16 mm, 7" (18 cm)

### SAYRE PERIOSTEAL ELEVATOR

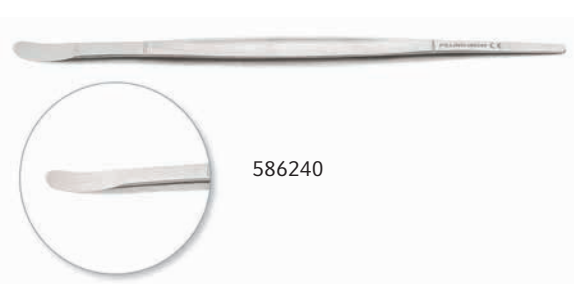

586240

ITEM #	DESCRIPTION
586240	Double-ended, 4 mm straight blunt end, 8 mm curved sharp end, 6-5/8" (17 cm)

### SAYRE PERIOSTEAL ELEVATOR



KM58076

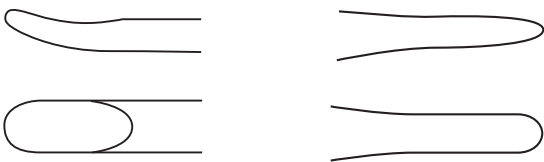

ITEM #	DESCRIPTION
KM58075	Double-ended, 5 mm sharp end, 9 mm sharp end, 6-1/2" (16.5 cm)
KM58076	Double-ended, 5 mm blunt end, 9 mm blunt end, 6-1/2" (16.5 cm)



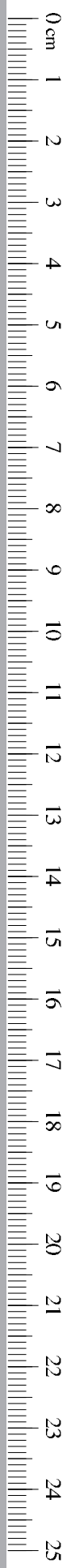

# DISSECTORS AND ELEVATORS

## Periosteal Elevators

### PERIOSTEAL ELEVATOR



Phenolic handle, 7-1/2" (19 cm).

KM46211

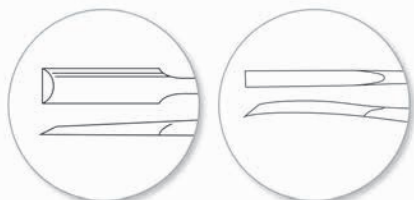

KM46211

KM46206

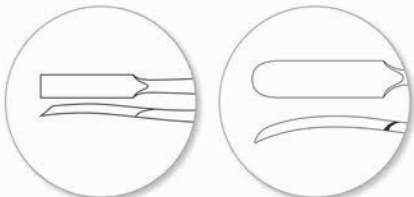

KM46207

KM46212

ITEM #	DESCRIPTION
KM46206	Sharp, curved blade, 3 mm straight edge
KM46207	Sharp, curved blade, 6 mm straight edge
KM46211	Sharp, straight blade, 6 mm straight edge
KM46212	Sharp, curved blade, 6 mm round edge

\*Autoclavable to 290°F (143°C)

### PERIOSTEAL ELEVATOR



Phenolic handle.

KM46213

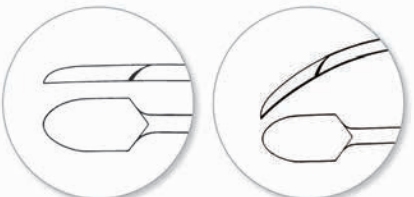

KM46213

KM46214

ITEM #	DESCRIPTION
KM46213	Sharp, straight blade, 14 mm oval edge, 7-7/8" (20 cm)
KM46214	Sharp, curved blade, 14 mm oval edge, 7-5/8" (19.5 cm)

\*Autoclavable to 290°F (143°C)



# DISSECTORS AND ELEVATORS

## Periosteal Elevators

### PERIOSTEAL ELEVATOR

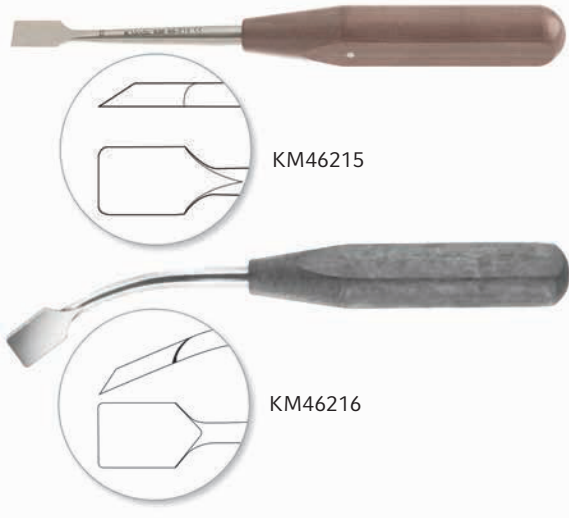

Phenolic handle.

ITEM #	DESCRIPTION
KM46215	Sharp, straight blade, 13 mm straight edge, 7-1/4" (18.5 cm)
KM46216	Sharp, curved blade, 13 mm straight edge, 7-5/8" (19.5 cm)
KM46217	Sharp, straight blade, 20 mm round edge, 7-7/8" (20 cm)

\*Autoclavable to 290°F (143°C)



## Cobb Elevators

### COBB SPINAL ELEVATORS, HEX HANDLE



KM49342

All stainless steel and hexagonal handle.  
Sharp, 9-1/2" (24 cm).

ITEM #	TIP WIDTH
KM49340	1/2" (13 mm)
KM49342	3/4" (19 mm)
KM49344	1" (25.5 mm)
KM49346	1-1/4" (32 mm)

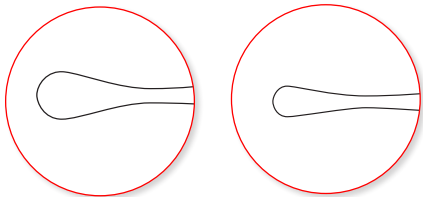

KM49342

KM49340

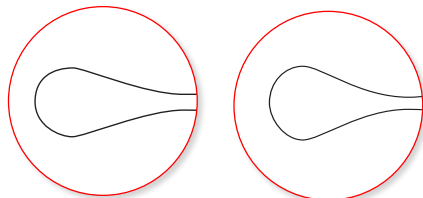

KM49344

KM49346





# DISSECTORS AND ELEVATORS

## Cobb Elevators

### COBB SPINAL ELEVATORS, ALUMINUM HANDLE



KM46414

All stainless steel working end and anodized aluminum handle. Sharp, 11" (28 cm).

ITEM #	TIP WIDTH
KM46413	3/8" (10 mm)
KM46414	1/2" (12 mm)
KM46416	3/4" (19 mm)
KM46418	1" (25 mm)
KM46420	1-1/4" (32 mm)

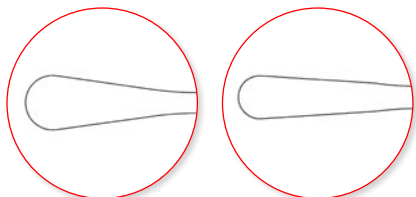

KM46414

KM46413

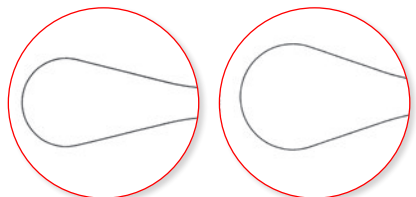

KM46416

KM46418

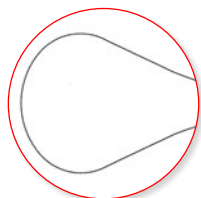

KM46420

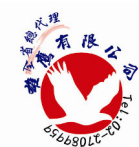

# DISSECTORS AND ELEVATORS

## Cobb Elevators

### COBB SPINAL ELEVATORS, STAINLESS STEEL HANDLE



KM46414S

All stainless steel working end and handle.  
Sharp, 11" (28 cm).

ITEM #	TIP WIDTH
KM46413S	3/8" (10 mm)
KM46414S	1/2" (12 mm)
KM46416S	3/4" (19 mm)
KM46418S	1" (25 mm)
KM46420S	1-1/4" (32 mm)

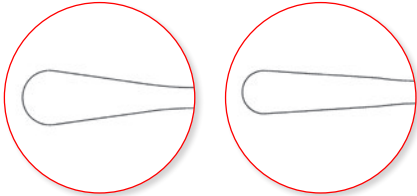

KM46414S

KM46413S

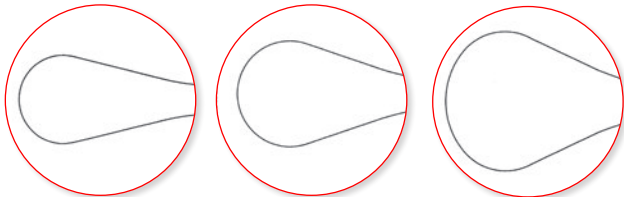

KM46416S

KM46418S

KM46420S

## Endoscopic Elevators

### ENDOSCOPIC COBB ELEVATORS



KM55614

Phenolic handle.

ITEM #	TIP WIDTH	TIP LENGTH	SHAFT LENGTH	SHAFT DIAMETER	HANDLE LENGTH	OVERALL LENGTH
KM55620	1/4" (6 mm)	2.7"	9.3"	0.285" (7.2 mm)	5"	17" (43 cm)
KM55610	1/4" (6 mm)	3-1/2"	10"	0.45" (11.5 mm)	6-1/2"	20" (51 cm)
KM55612	3/8" (10 mm)	3-1/2"	10"	0.45" (11.5 mm)	6-1/2"	20" (51 cm)
KM55614	0.49" (12.5 mm)	3-1/2"	10"	0.45" (11.5 mm)	6-1/2"	20" (51 cm)

Phenolic handles autoclavable to 290°F (143°C)

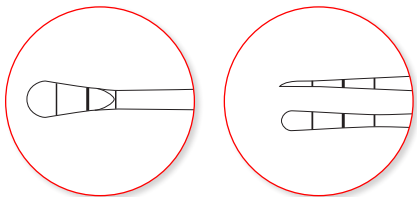

KM55614

KM55620

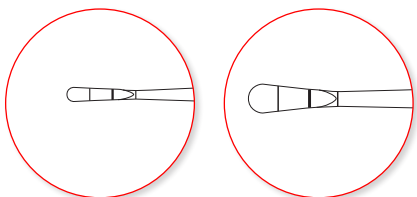

KM55610

KM55612





# DISSECTORS AND ELEVATORS

## Endoscopic Elevators

### ENDOSCOPIC PENFIELD ELEVATOR

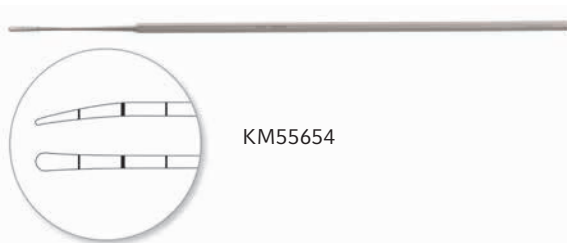

Stainless steel handle.

ITEM #	TIP WIDTH	TIP LENGTH	SHAFT DIAMETER	HANDLE LENGTH	OVERALL LENGTH
KM55654	0.16" (4 mm)	3-1/2"	0.280" (7 mm)	11-1/2"	15" (38 cm)

### ENDOSCOPIC RIB ELEVATORS

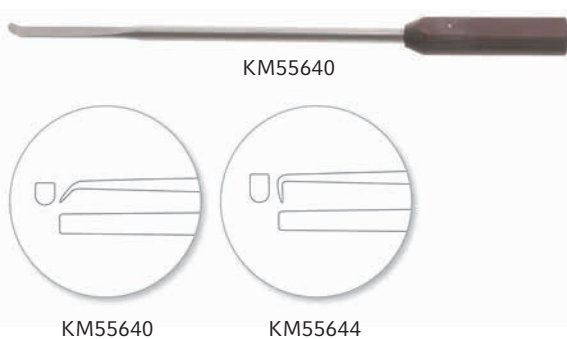

Sharp, with phenolic handle.

ITEM #	TIP SHAPE	TIP WIDTH	TIP LENGTH	SHAFT LENGTH	SHAFT DIAMETER	HANDLE LENGTH	OVERALL LENGTH
KM55640	Angled 45 degrees	9 mm radius	4"	8"	0.45" (11.5 mm)	5"	17" (43 cm)
KM55644	Curved 90 degrees	9 mm radius	4"	8"	0.45" (11.5 mm)	5"	17" (43 cm)

*Phenolic handles autoclavable to 290°F (143°C)*

## Specialty Elevators

### DARRACH ELEVATORS



Useful in shoulder surgery. Blunt tips with serrations can be used to elevate or retract soft tissue and muscle from the operative site.

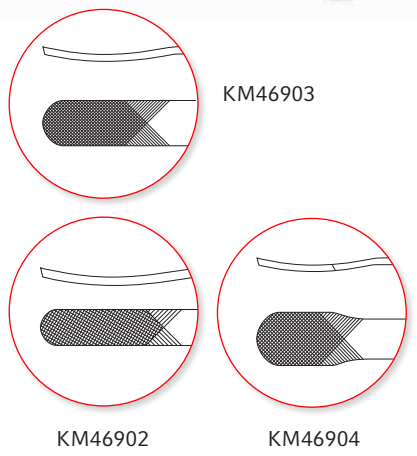

ITEM #	DESCRIPTION
KM46902	Small, 1/2" (12 mm) wide at tip, 10-1/4" (26 cm)
KM46903	Medium, 3/4" (19 mm) wide at tip, 10-1/4" (26 cm)
KM46904	Large, 1" (25 mm) wide at tip, 13-3/4" (35 cm)



# DISSECTORS AND ELEVATORS

## Specialty Elevators

### HARRINGTON SPINAL ELEVATOR



KM55798

All stainless steel.

ITEM #	DESCRIPTION
KM55798	Sharp, 3/4" (19 mm) wide tip, 12" (30.5 cm)

### CHANDLER ELEVATORS



KM46252

Blunt, slightly curved.

ITEM #	TIP WIDTH	LENGTH
KM46250	8 mm	7-1/8" (18 cm)
KM46252	12 mm	8" (20.5 cm)
KM46254	17 mm	9" (23 cm)
KM46256	19 mm	10" (25.5 cm)

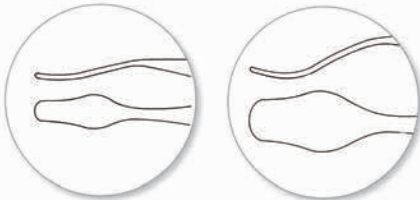

KM46250

KM46252

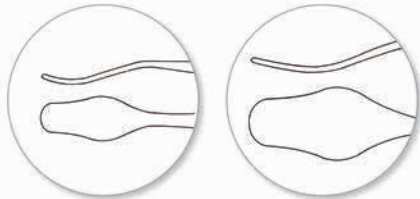

KM46254

KM46256

### SACHS NERVE ELEVATOR

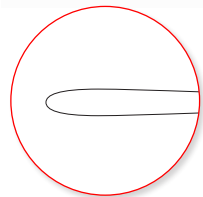

KM57618

ITEM #	DESCRIPTION
KM57618	3 mm blunt, 7-1/2" (19 cm)







# BONE FILES AND RASPS

## Bone Files

### BONE FILE #10



KM69542

ITEM #	DESCRIPTION
KM69542	Double-ended, plain serrations, 5 mm width, 7-1/8" (18 cm)

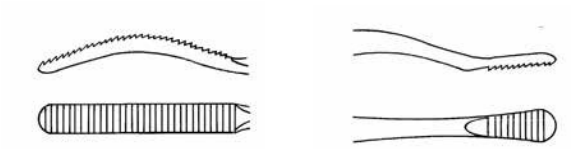

### BONE FILE #12



KM69543

ITEM #	DESCRIPTION
KM69543	Double-ended, plain serrations, 7 and 5 mm width, 7-1/8" (18 cm)

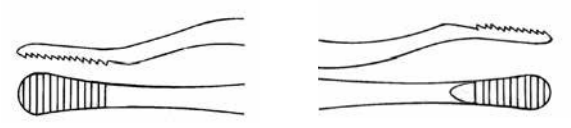

### BONE FILE #12A



KM69544

ITEM #	DESCRIPTION
KM69544	Double-ended, plain and cross serrations, 5 mm width, 7-1/8" (18 cm)

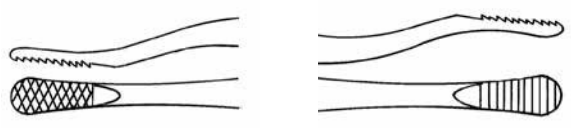



# BONE FILES AND RASPS

## Bone Files

### BONE FILE #12CA



KM69545

ITEM #	DESCRIPTION
KM69545	Double-ended, cross serrations, 5 and 7 mm width, 7-1/8" (18 cm)



### BONE FILE #33



KM69546

ITEM #	DESCRIPTION
KM69546	Double-ended, plain serrations, 6 and 5 mm width, 7-1/8" (18 cm)



### BONE FILE #45



KM69549

ITEM #	DESCRIPTION
KM69549	Double-ended, plain serrations, 6 and 5 mm width, 7-1/4" (18.5 cm)



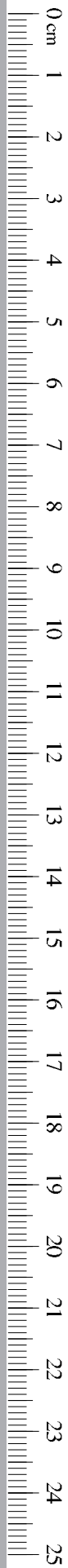

# BONE FILES AND RASPS

## Bone Files

### BONE RASP #64



ITEM #	DESCRIPTION
KM58070	Double-ended, plain serrations, 3 and 4 mm width, 7-1/8" (18 cm)



### BONE FILE #92A



Single-ended, delicate, plain serrations.

ITEM #	DESCRIPTION
KM69530	Angled downward

### BONE FILE #92B



Single-ended, delicate, plain serrations.

ITEM #	DESCRIPTION
KM69534	Angled upward

### NAIL RASP #93



ITEM #	DESCRIPTION
KM69538	Double-ended, 2 mm wide, angled, 6-3/4" (17 cm)





# BONE FILES AND RASPS

## Bone Files

### BONE FILE

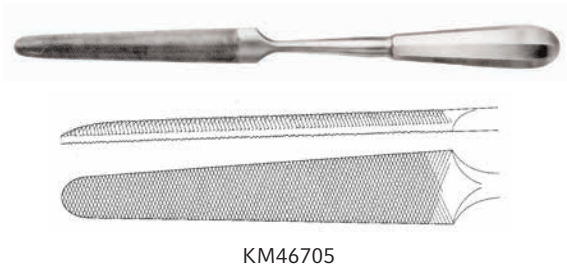

Single-ended, 2-sided, convex and flat blade 23 mm wide tapers to 6 mm.

ITEM #	DESCRIPTION
KM46705	11" (28 cm)

### BONE FILE



Single-ended, bayonet shank, half round blade.

ITEM #	DESCRIPTION
KM46650	Fine teeth, 15 mm wide, 9-1/2" (24 cm)

## Bone Rasps

### PUTTI BONE RASP



Double-ended. One round blade, 10 mm wide, tapers to 4 mm, and one half round blade, 15 mm wide, tapers to 5 mm.

ITEM #	DESCRIPTION
KM46652	12" (30.5 cm)

### PUTTI BONE RASP



Double-ended. Flat blades, 18 mm wide, taper to 4 mm. One blade end is curved up and one end is curved sideways.

ITEM #	DESCRIPTION
KM46654	10-3/8" (26.5 cm)





# BONE FILES AND RASPS

## Bone Rasps

### AUFRICHT RASPS



ITEM #	DESCRIPTION
052162	Forward-cutting, 25 x 9 mm, 8" (20.5 cm)
KM58050	Forward-cutting, 8.5 mm wide, 8-1/4" (21 cm)
KM58052	Backward-cutting, 9 mm wide, 8-1/4" (21 cm)

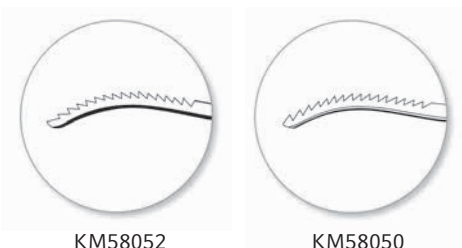

### AUFRICHT-GLABELLA RASP



ITEM #	DESCRIPTION
052165	Up and down-cutting, 9 x 30 mm, 7-1/2" (19 cm)

### BONE RASP

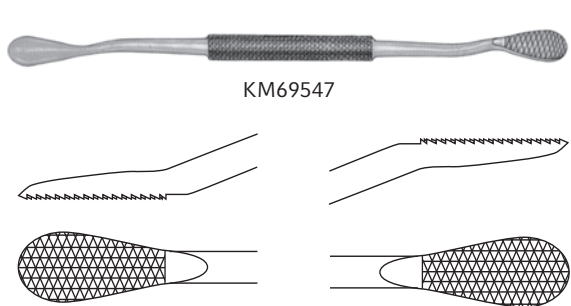

For rapid shaping of bone.

ITEM #	DESCRIPTION
KM69547	Double-ended, fine and coarse cross serrations, 13 mm wide, 8-1/2" (21.5 cm)





# BONE FILES AND RASPS

## Bone Rasps

### CONVERSE RASP



ITEM #	DESCRIPTION
052180	Double-ended, fine and coarse serrations, 7-1/8" (18 cm)

### COTTLE RASP



ITEM #	DESCRIPTION
052130	Straight down-cutting blade, 9 mm width, 8-1/4" (21 cm)

### FOMAN RASP



Double-ended. Fine and coarse serrations. 4-sided, convex and flat blades.

ITEM #	DESCRIPTION
KM46655	8-1/2" (21.5 cm)

### JOSEPH RASP



ITEM #	DESCRIPTION
441530	Fine serrations, 6-1/8" (15.5 cm)





# BONE FILES AND RASPS

## Bone Rasps

### KLEINERT-KUTZ BONE RASP



KM46653

Double-ended. Fine and coarse serrations. 4-sided, convex and flat blades.

ITEM #	DESCRIPTION
KM46653	8-7/8" (22.5 cm)

### KLEINERT-KUTZ RASP



441555

ITEM #	DESCRIPTION
441555	4-sided tips, 7.5 mm wide, 8-5/8" (22 cm)

### LEWIS RASPS



KM58072

Single-ended bayonet shank, plain serrations, 8 mm wide, 7-1/2" (19 cm).

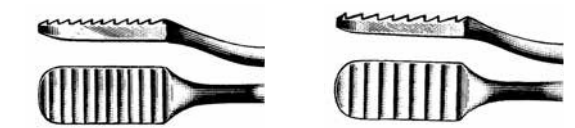

KM58072

KM58073

ITEM #	DESCRIPTION
KM58072	Fine serrations
KM58073	Coarse serrations





# BONE FILES AND RASPS

## Bone Rasps

### MALTZ RASP



ITEM #	DESCRIPTION
052100	Straight down-cutting blade, 6 mm width, 7-1/8" (18 cm)

### MALTZ RASP IMPROVED



ITEM #	DESCRIPTION
KM58062	Double-ended, forward and backward-cutting, 8 mm wide, 8-1/4" (21 cm)

### POLOKOFF BONE RASPS



KM69540

Double-ended, plain serrations.

ITEM #	DESCRIPTION
KM69540	6 mm wide, 7-7/8" (20 cm)
KM69541	3 and 4 mm wide, 7-7/8" (20 cm)



KM69540



KM69541







# BONE FILES AND RASPS

## Rib Rasps

### ALEXANDER PERIOSTEAL RASP



KM58110

ITEM #	DESCRIPTION
KM58110	11 mm Sharp, 8-1/8" (20.5 cm)

### FARABEUZ PERIOSTEAL RASPS



KM58108

Single-ended, Sharp, 5-7/8" (15 cm).

ITEM #	DESCRIPTION
KM58106	Straight blade, 13 mm curved edge
KM58108	Curved blade, 13 mm straight edge

### KIRMISSION PERIOSTEAL RASP



KM58112

ITEM #	DESCRIPTION
KM58112	Sharp, 6-3/4" (17 cm)





# CURETTES

## Brun Currettes

### BRUN (SPRATT) CURETTES

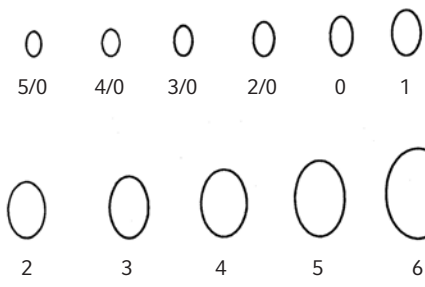

Oval cup, hollow handle.

ITEM #	TIP SHAPE	SIZE	LENGTH
KM46511	Straight	#5/0	7" (18 cm)
KM46512	Straight	#4/0	7" (18 cm)
KM46513	Straight	#3/0	7" (18 cm)
KM46515	Straight	#2/0	7" (18 cm)
KM46517	Straight	#0	7" (18 cm)
KM46519	Straight	#1	7" (18 cm)
KM46521	Straight	#2	7" (18 cm)
KM46523	Straight	#3	7" (18 cm)
KM46525	Straight	#4	7" (18 cm)
KM46529	Straight	#5	7" (18 cm)
KM46531	Straight	#6	7" (18 cm)
KM46563	Straight	#3/0	9" (23 cm)
KM46564	Straight	#2/0	9" (23 cm)
KM46565	Straight	#0	9" (23 cm)
KM46566	Straight	#1	9" (23 cm)
KM46567	Straight	#2	9" (23 cm)
KM46568	Straight	#3	9" (23 cm)
KM46569	Straight	#4	9" (23 cm)
KM46570	Straight	#5	9" (23 cm)
KM46571	Straight	#6	9" (23 cm)
KM49110	Angled 45 degrees	#3/0	9" (23 cm)
KM49111	Angled 45 degrees	#2/0	9" (23 cm)
KM49112	Angled 45 degrees	#0	9" (23 cm)
KM49113	Angled 45 degrees	#1	9" (23 cm)
KM49114	Angled 45 degrees	#2	9" (23 cm)
KM49115	Angled 45 degrees	#3	9" (23 cm)
KM49116	Angled 45 degrees	#4	9" (23 cm)
KM49117	Angled 45 degrees	#5	9" (23 cm)
KM49118	Angled 45 degrees	#6	9" (23 cm)





# CURETTES

## Brun Currettes

### BRUN (SPRATT) CURETTES

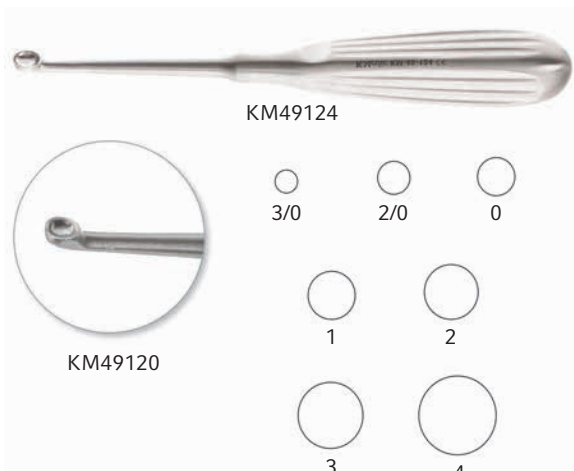

Round up, hollow handle.

ITEM #	TIP SHAPE	SIZE	LENGTH
KM49120	Straight	#3/0	6-3/4" (17 cm)
KM49121	Straight	#2/0	6-3/4" (17 cm)
KM49122	Straight	#0	6-3/4" (17 cm)
KM49123	Straight	#1	6-3/4" (17 cm)
KM49124	Straight	#2	6-3/4" (17 cm)
KM49125	Straight	#3	6-3/4" (17 cm)
KM49126	Straight	#4	6-3/4" (17 cm)





# CURETTES

## Brun Currettes

### BRUNS CURETTES

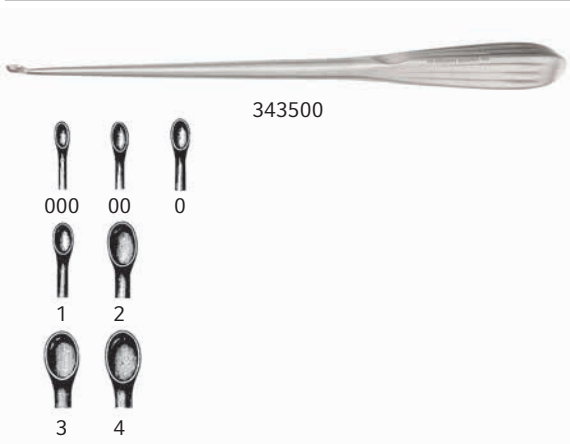

Pilling® Pattern, 8-7/8" (22.5 cm).

ITEM #	DESCRIPTION
343500	Size 000
343501	Size 00
343502	Size 0
343503	Size 1
343504	Size 2
343505	Size 3
343506	Size 4

### BRUN CURETTES

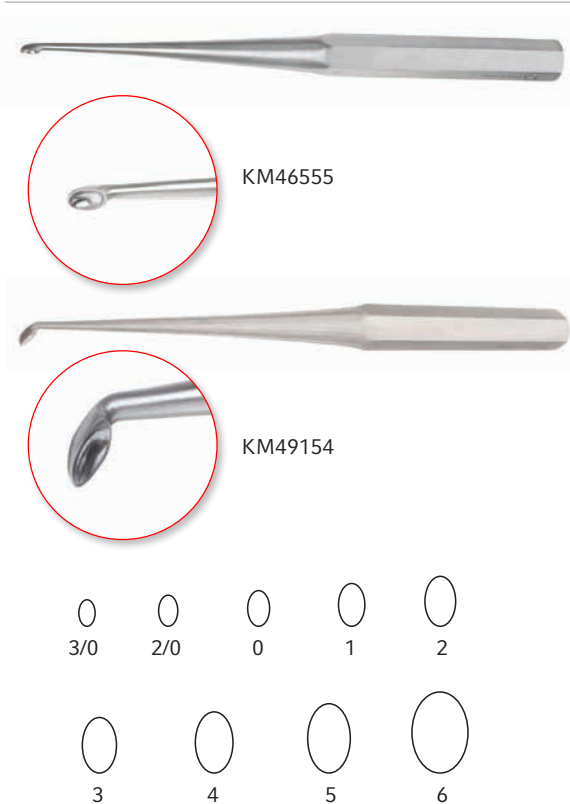

Solid hexagonal handle, 9" (23 cm).

ITEM #	TIP SHAPE	SIZE
KM46551	Straight	#3/0
KM46552	Straight	#2/0
KM46553	Straight	#0
KM46554	Straight	#1
KM46555	Straight	#2
KM46556	Straight	#3
KM46557	Straight	#4
KM46558	Straight	#5
KM46559	Straight	#6

KM49150	Angled 45 degrees	#3/0
KM49151	Angled 45 degrees	#2/0
KM49152	Angled 45 degrees	#0
KM49153	Angled 45 degrees	#1
KM49154	Angled 45 degrees	#2
KM49155	Angled 45 degrees	#3
KM49156	Angled 45 degrees	#4
KM49157	Angled 45 degrees	#5
KM49158	Angled 45 degrees	#6



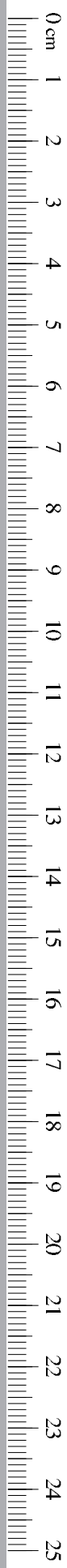

# CURETTES

## Cobb Currettes

### COBB CURETTES, ALUMINUM HANDLE



All stainless steel working end and anodized aluminum, knurled handle, 11" (28 cm).

ITEM #	TIP SHAPE	SIZE
KM46422	Straight	#3/0
KM46423	Straight	#2/0
KM46424	Straight	#0
KM46425	Straight	#1
KM46426	Straight	#2
KM46427	Straight	#3
KM46428	Straight	#4
KM46429	Straight	#5
KM46430	Straight	#6
KM46433	Angled	#3/0
KM46434	Angled	#2/0
KM46435	Angled	#0
KM46436	Angled	#1
KM46437	Angled	#2
KM46438	Angled	#3
KM46439	Angled	#4
KM46440	Angled	#5
KM46441	Angled	#6



# CURETTES

## Cobb Currettes

### COBB CURETTES, STAINLESS STEEL HANDLE



All stainless steel working end and stainless steel, knurled handle, 11" (28 cm).



KM46427S



KM46438S

ITEM #	TIP SHAPE	SIZE
KM46422S	Straight	#3/0
KM46423S	Straight	#2/0
KM46424S	Straight	#0
KM46425S	Straight	#1
KM46426S	Straight	#2
KM46427S	Straight	#3
KM46428S	Straight	#4
KM46429S	Straight	#5
KM46430S	Straight	#6
KM46433S	Angled	#3/0
KM46434S	Angled	#2/0
KM46435S	Angled	#0
KM46436S	Angled	#1
KM46437S	Angled	#2
KM46438S	Angled	#3
KM46439S	Angled	#4
KM46440S	Angled	#5
KM46441S	Angled	#6

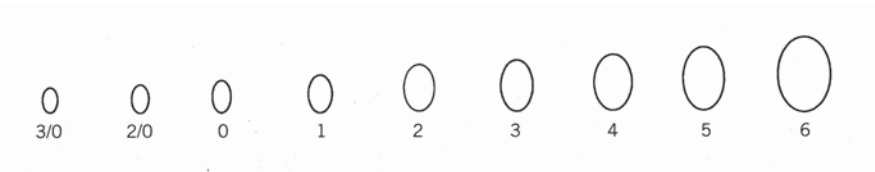

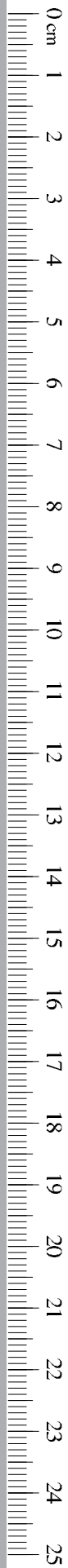

# CURETTES

## Specialty Bone Curettes

### EPSTEIN CURETTES



KM49584

Reverse angle, hollow handle, 8" (20.5 cm).

ITEM #	DESCRIPTION
KM49580	#000
KM49582	#00
KM49584	#0

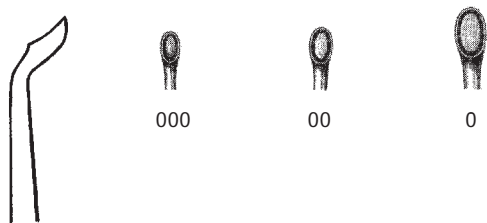

### SCOVILLE CURETTES



KM49574

ITEM #	DESCRIPTION
KM49574	Straight, 10" (25.5 cm)
KM49576	Down angle, 10" (25.5 cm)
KM49578	Up angle, 10" (25.5 cm)



KM49576



KM49578



# CURETTES

## Specialty Bone Curettes

### HATFIELD BONE CURETTES

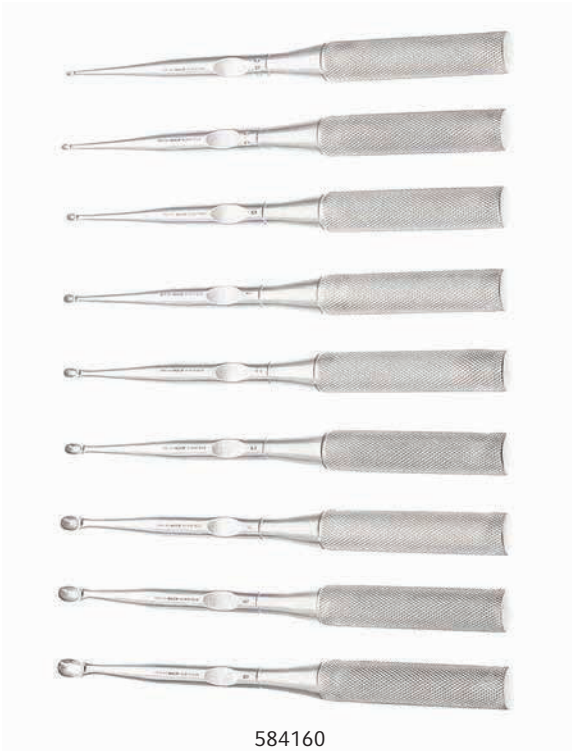

Stainless steel with satin finish. Oval shaped tips, overall length 9" (23 cm). Complete set of nine curettes.

ITEM #	SIZE	TIP WIDTH	TIP LENGTH
584160	000	2.5 mm	4.0 mm
	00	2.8 mm	4.6 mm
	0	3.3 mm	5.0 mm
	1	3.8 mm	6.0 mm
	2	4.8 mm	7.6 mm
	3	5.8 mm	9.2 mm
	4	7.2 mm	11.6 mm
	5	8.7 mm	12.8 mm
	6	10.5 mm	15.5 mm

### JANSEN CURETTE



ITEM #	DESCRIPTION
KM29632	Double-ended, oval cups, 6" (15 cm)







# CURETTES

## Specialty Bone Curettes

### MARTINI BONE CURETTE



ITEM #	DESCRIPTION
KM29620	Double-ended, 4 mm and 5 mm round cups, 5-1/2" (14 cm)

### WILLIGER BONE CURETTE

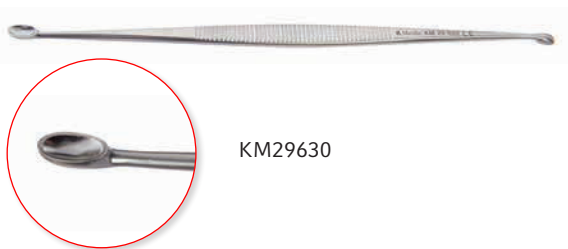

ITEM #	DESCRIPTION
KM29630	Double-ended, 3 mm and 4 mm oval cups, 5-1/2" (14 cm)

### VOLKMANN CURETTES



Double-ended, oval cups.

ITEM #	DESCRIPTION
KM49200	Double-ended, straight, 5" (12.5 cm)
KM49202	Double-ended, straight, 5 1/2" (14 cm)
KM46550	Double-ended, oval cups, 6 1/2" (16.5 cm)
KM49204	Double-ended, straight, 8" (20.5 cm)



KM49200



KM46550



KM49202



KM49204



# CURETTES

## Specialty Bone Curettes

### VOLKMANN CURETTES

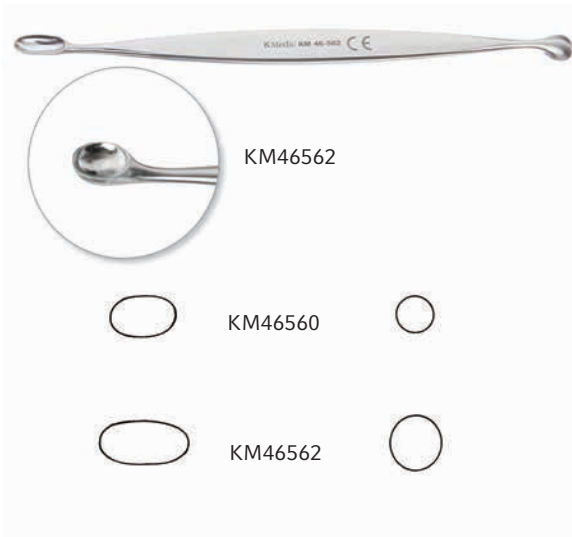

Double-ended, oval and round cups.

ITEM #	DESCRIPTION
KM46560	5" (12.5 cm)
KM46561	8" (20.5 cm)
KM46562	6-1/2" (16.5 cm)

### CONE RING CURETTES



Knurled handle and fenestrated cup, 9" (23 cm).

ITEM #	TIP SHAPE	SIZE	TIP
KM49450	Straight	#1	8 mm diameter
KM49452	Straight	#2	6 mm diameter
KM49454	Straight	#3	3 mm diameter
KM49456	Angled 35 degrees	#1	8 mm diameter
KM49458	Angled 35 degrees	#2	6 mm diameter
KM49460	Angled 35 degrees	#3	3 mm diameter



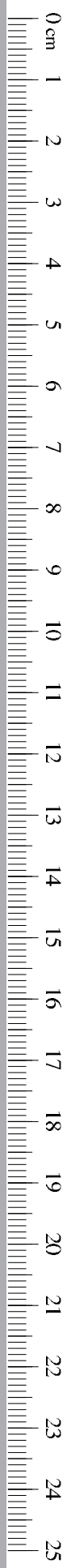

# CURETTES

## Specialty Bone Curettes

### RING CURETTES



Hollow handle with fenestrated cup.

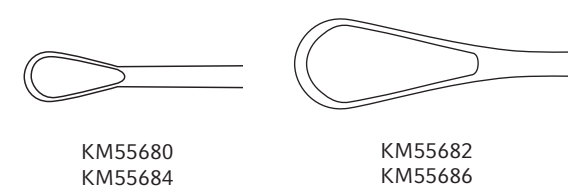
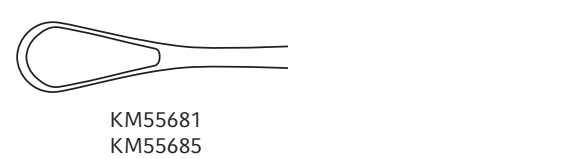

ITEM #	DESCRIPTION
KM55680	Size 0, small, 10" (25.5 cm)
KM55684	Size 0, small, 11-1/2" (29 cm)
KM55681	Size 2, medium, 10" (25.5 cm)
KM55685	Size 2, medium, 11-1/2" (29 cm)
KM55682	Size 6, large, 10-1/4" (26 cm)
KM55686	Size 6, large, 12" (30.5 cm)

### RAY PITUITARY CURETTES



7-1/2" (19 cm).

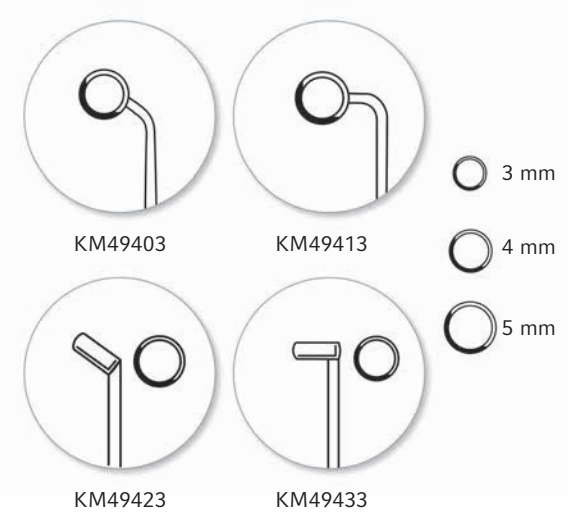

ITEM #	TIP SHAPE	TIP
KM49403	Vertical angle 45 degrees	3 mm
KM49404	Vertical angle 45 degrees	4 mm
KM49405	Vertical angle 45 degrees	5 mm
KM49413	Vertical angle 90 degrees	3 mm
KM49414	Vertical angle 90 degrees	4 mm
KM49415	Vertical angle 90 degrees	5 mm
KM49423	Horizontal angle 45 degrees	3 mm
KM49424	Horizontal angle 45 degrees	4 mm
KM49425	Horizontal angle 45 degrees	5 mm
KM49433	Horizontal angle 90 degrees	3 mm
KM49434	Horizontal angle 90 degrees	4 mm
KM49435	Horizontal angle 90 degrees	5 mm



# CURETTES

## Endoscopic Currettes

### ENDO BRUN CURETTES

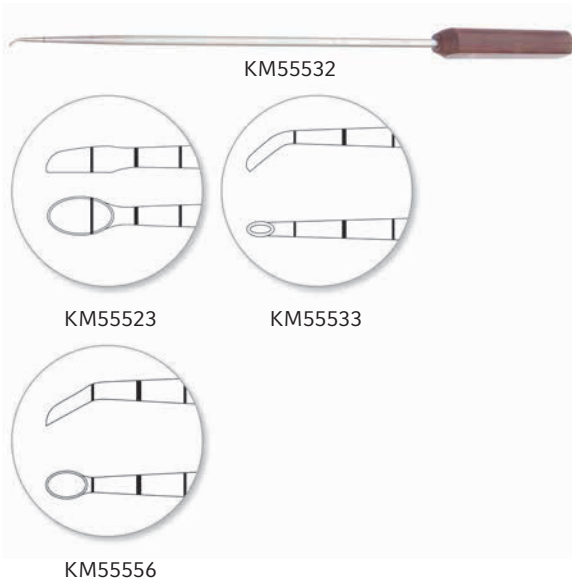

Endoscopic with phenolic handle.

ITEM #	TIP SHAPE	TIP	TIP LENGTH	SHAFT LENGTH	SHAFT DIA.	HANDLE LENGTH	OVERALL LENGTH
KM55532	Angled 40°	2 x 4 mm cup	2.7"	9.3"	0.285"	5"	17" (43 cm)
KM55523	Straight	3 x 6 mm cup	2.7"	9.3"	0.285"	5"	17" (43 cm)
KM55533	Angled 40°	3 x 6 mm cup	2.7"	9.3"	0.285"	5"	17" (43 cm)
KM55543	Angled 40°	3 x 6 mm cup	3-1/2"	10"	0.45"	6-1/2"	20" (51 cm)
KM55556	Angled 30°	6 x 9 mm cup	3-1/2"	10"	0.45"	6-1/2"	20" (51 cm)





# CURETTES

## Endoscopic Curettes

### ENDO CONE RING CURETTES

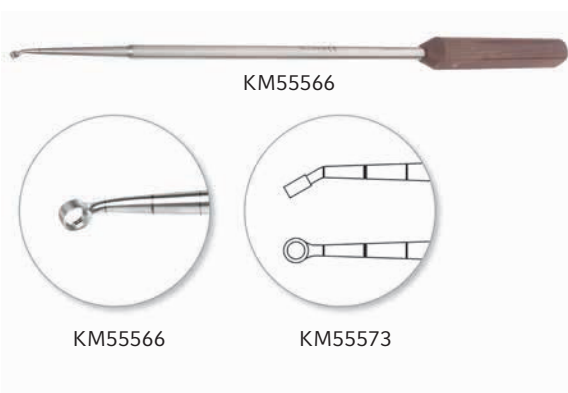

Endoscopic with phenolic handle.

ITEM #	TIP SHAPE	TIP	TIP LENGTH	SHAFT LENGTH	SHAFT DIA.	HANDLE LENGTH	OVERALL LENGTH
KM55573	Angled 40°	3 mm	2.7"	9.3"	0.285"	5"	17" (43 cm)
KM55566	Angled 30°	6 mm	3-1/2"	10"	0.45"	6-1/2"	20" (51 cm)

### ENDO EPSTEIN CURETTES

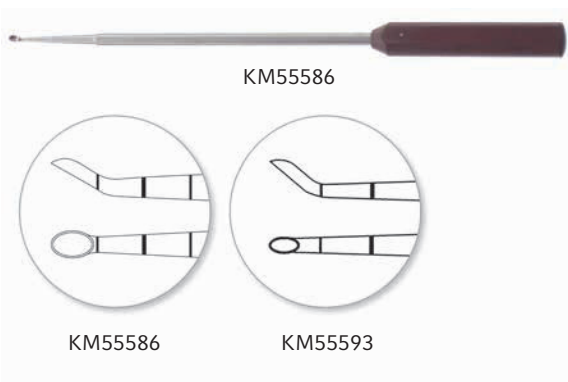

ITEM #	TIP SHAPE	TIP	TIP LENGTH	SHAFT LENGTH	SHAFT DIA.	HANDLE LENGTH	OVERALL LENGTH
KM55593	Reverse-angled 40°	3 x 6 mm	2.7"	9.3"	0.285"	5"	17" (43 cm)
KM55586	Reverse-angled 30°	6 x 9 mm	3-1/2"	10"	0.45"	6-1/2"	20" (51 cm)

### ENDO SCOVILLE CURETTE

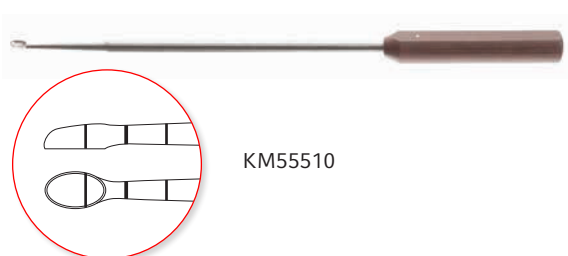

Endoscopic with phenolic handle.

ITEM #	TIP SHAPE	TIP	TIP LENGTH	SHAFT LENGTH	SHAFT DIA.	HANDLE LENGTH	OVERALL LENGTH
KM55510	Straight	9 x 15 mm	3-1/2"	10"	0.45"	6-1/2"	20" (51 cm)



# CURETTES

## SmartTrack Curette Sterilizing Tray

### BRUN SMARTRACK FOR 7" CURETTES

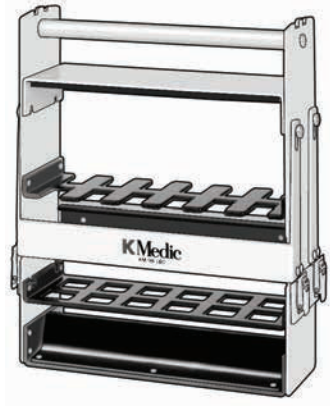

KM98160

Aluminum and stainless steel.

ITEM #	DESCRIPTION
KM98160	Holds twelve 7" KMedic® Brun Currettes

### COBB SMARTRACK FOR 11" INSTRUMENTS



KM98170

Aluminum and stainless steel.

ITEM #	DESCRIPTION
KM98170	Holds nine 11" KMedic® Cobb Currettes, Elevators or Gouges

### HIBBS AND BRUN SMARTRACK FOR 9" INSTRUMENTS



KM98180

Aluminum and stainless steel.

ITEM #	DESCRIPTION
KM98180	Holds twelve 9" KMedic® Brun Currettes, or Hibbs Chisels, Gouges or Osteotomes



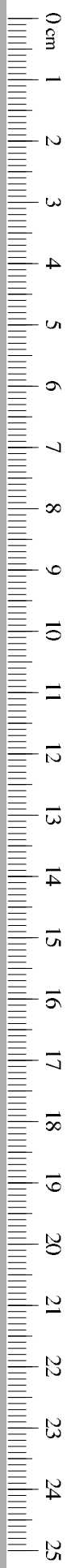

# OSTEOTOMES

## Lambotte

### MINI-LAMBOTTE OSTEOTOMES, STRAIGHT 5"



KM46342

Straight, without calibration lines, 5" (12.5 cm).

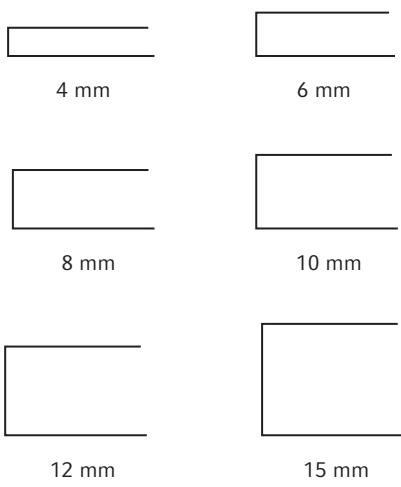

ITEM #	DESCRIPTION
KM46336	1/8" (4 mm)
KM46338	1/4" (6 mm)
KM46340	5/16" (8 mm)
KM46342	3/8" (10 mm)
KM46344	1/2" (12 mm)
KM46343	9/16" (14 mm)
KM46345	5/8" (15 mm)
KM46346	11/16" (18 mm)
KM46347	3/4" (19 mm)
KM46335	13/16" (20 mm)

### LAMBOTTE-STYLE OSTEOTOMES



051086

Pilling® Pattern, flat thin blade, 5" (12.5 cm).

ITEM #	DESCRIPTION
051082	2 mm
051084	4 mm
051086	6 mm
051088	8 mm
051090	10 mm
051092	12 mm
051095	15 mm





# OSTEOTOMES

## Lambotte

### LAMBOTTE OSTEOTOMES, STRAIGHT 7"



KM46348

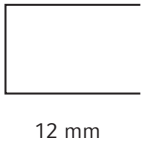
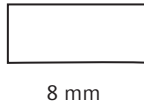

Straight, with calibration lines, 7" (18 cm).

ITEM #	DESCRIPTION
KM46348	1/8" (4 mm)
KM46349	3/16" (5 mm)
KM46350	1/4" (6 mm)
KM46358	5/16" (8 mm)
KM46351	3/8" (10 mm)
KM46352	1/2" (12 mm)
KM46353	5/8" (16 mm)
KM46354	3/4" (19 mm)
KM46355	7/8" (22 mm)
KM46356	1" (25 mm)

### LONG BEVEL OSTEOTOMES



KM69940

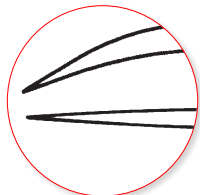

The unusually long bevel allows the cut bone to bend gradually as it is cut. Calibration lines, 7" (18 cm).

ITEM #	DESCRIPTION
KM69940	Straight, 10 mm
KM69946	Straight, 20 mm
KM69950	Straight, 25 mm
KM69970	Curved, 5 mm
KM69975	Curved, 10 mm







# OSTEOTOMES

## Lambotte

### LAMBOTTE OSTEOTOMES, STRAIGHT 9"



KM46310

Straight, without calibration lines, 9" (23 cm).

ITEM #	DESCRIPTION
KM46304	1/4" (6 mm)
KM46306	1/2" (13 mm)
KM46310	3/4" (19 mm)
KM46314	1" (25 mm)
KM46318	1-1/4" (32 mm)
KM46322	1-1/2" (38 mm)

6 mm

12 mm

19 mm

25 mm

32 mm

### LAMBOTTE OSTEOTOMES, CURVED 9"



KM46330

Curved, without calibration lines, 9" (23 cm).

ITEM #	DESCRIPTION
KM46328	1/4" (6 mm)
KM46329	1/2" (12 mm)
KM46330	3/4" (19 mm)
KM46331	1" (25 mm)
KM46332	1-1/4" (32 mm)
KM46333	1-1/2" (38 mm)

6 mm

12 mm

19 mm

25 mm

32 mm





# OSTEOTOMES

Specialty

## OSTEOTOMES



051104

Flat thin blade, 6" (15 cm).

ITEM #	DESCRIPTION
051102	2 mm
051103	3 mm
051104	4 mm
051105	5 mm
051106	6 mm
051107	7 mm
051110	10 mm

## MINI OSTEOTOMES



441208

Curved, 5" (12.5 cm).

ITEM #	DESCRIPTION
441207	4 mm
441208	6 mm

Hoke

## HOKE OSTEOTOMES



KM46499

5-1/4" (13.5 cm).

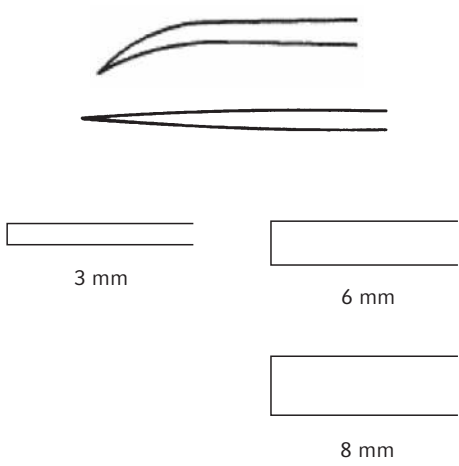

ITEM #	TIP	TIP WIDTH
KM46497	Straight	1/8" (3 mm)
KM46498	Straight	3/16" (4 mm)
KM46499	Straight	1/4" (6 mm)
KM46500	Straight	5/16" (8 mm)
KM46501	Straight	3/8" (10 mm)
KM46502	Straight	1/2" (13 mm)
KM46503	Straight	5/8" (16 mm)
KM46504	Straight	3/4" (19 mm)
KM46700	Curved	1/8" (3 mm)
KM46701	Curved	3/16" (4 mm)
KM46702	Curved	1/4" (6 mm)
KM46703	Curved	5/16" (8 mm)
KM46704	Curved	3/8" (10 mm)
KM46706	Curved	1/2" (13 mm)
KM46708	Curved	5/8" (16 mm)
KM46709	Curved	3/4" (19 mm)





# OSTEOTOMES

Sheehan

## SHEEHAN OSTEOTOMES



KM46274

Straight, 6-1/4" (16 cm).



4 mm



8 mm



12 mm

ITEM #	DESCRIPTION
KM46268	2 mm
KM46270	4 mm
KM46272	6 mm
KM46274	8 mm
KM46276	10 mm
KM46278	12 mm
KM46280	15 mm

Silver

## SILVER OSTEOTOMES



KM58100

Single guard, 7" (18 cm).

ITEM #	DESCRIPTION
KM58100	Straight
KM58102	Guard, right
KM58104	Guard, left

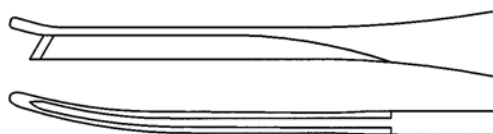

KM58102

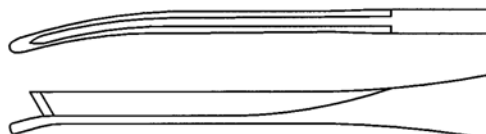

KM58104

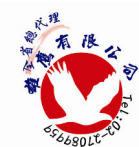



# OSTEOTOMES

US Army

## U.S. ARMY PATTERN OSTEOTOMES



KM46286

7" (18 cm).

ITEM #	DESCRIPTION
KM46284	6 mm
KM46286	12 mm
KM46288	18 mm

Stille

## STILLE OSTEOTOMES



KM49002

Straight, 8" (20.5 cm).

ITEM #	DESCRIPTION
KM49002	10 mm
KM49004	14 mm
KM49006	18 mm
KM49008	22 mm





# OSTEOTOMES

Hibbs

## HIBBS OSTEOTOMES



9" (23 cm).

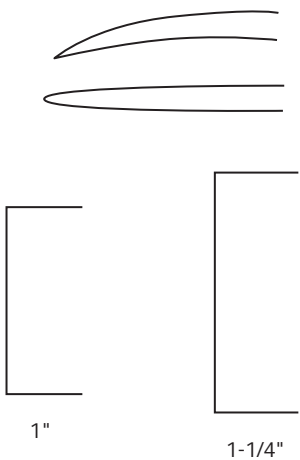

ITEM #	TIP	TIP WIDTH
KM46359	Straight	1/4"
KM46360	Straight	3/8"
KM46361	Straight	1/2"
KM46362	Straight	5/8"
KM46363	Straight	3/4"
KM46364	Straight	7/8"
KM46365	Straight	1"
KM46366	Straight	1-1/8"
KM46367	Straight	1-1/4"
KM46368	Straight	1-1/2"
KM46373	Curved	1/4"
KM46376	Curved	3/8"
KM46377	Curved	1/2"
KM46378	Curved	5/8"
KM46379	Curved	3/4"
KM46380	Curved	7/8"
KM46381	Curved	1"
KM46382	Curved	1-1/8"
KM46383	Curved	1-1/4"
KM46384	Curved	1-1/2"

## HIBBS ENDOSCOPIC OSTEOTOME

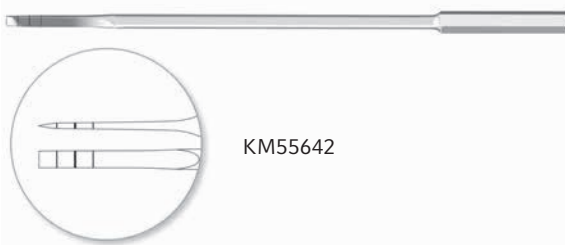

Straight tip, 18-1/2" (47 cm).

ITEM #	TIP WIDTH	TIP LENGTH	SHAFT LENGTH	SHAFT DIAMETER	HANDLE LENGTH
KM55642	3/8" (10 mm)	3-1/2"	10-3/4"	0.43" (11 mm)	4-1/4"



# OSTEOTOMES

Smith Peterson

## SMITH PETERSON OSTEOTOME



8" (20.5 cm).

ITEM #	TIP	TIP WIDTH
KM46448	Straight	1/4"
KM46449	Straight	3/8"
KM46450	Straight	1/2"
KM46451	Straight	5/8"
KM46452	Straight	3/4"
KM46453	Straight	1"
KM46454	Straight	1-1/4"
KM46457	Curved	1/4"
KM46458	Curved	3/8"
KM46459	Curved	1/2"
KM46460	Curved	5/8"
KM46461	Curved	3/4"
KM46462	Curved	1"
KM46463	Curved	1-1/4"



## Cobb

## COBB OSTEOTOME

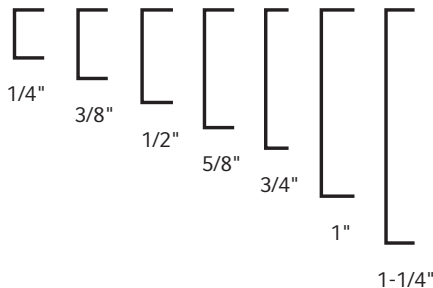

All stainless steel, 11" (28 cm).

ITEM #	DESCRIPTION
KM49350	Straight, 1/4"
KM49351	Straight, 3/8"
KM49352	Straight, 1/2"
KM49353	Straight, 5/8"
KM49354	Straight, 3/4"
KM49355	Straight, 1"
KM49356	Straight, 1-1/4"
KM49357	Curved, 1/4"
KM49358	Curved, 3/8"
KM49359	Curved, 1/2"
KM49360	Curved, 5/8"
KM49361	Curved, 3/4"
KM49362	Curved, 1"
KM49363	Curved, 1-1/4"





# OSTEOTOMES

## Interchangeable Osteotome, Chisel and Gouge Set

### INTERCHANGEABLE OSTEOTOME, CHISEL AND GOUGE SET



KM49630

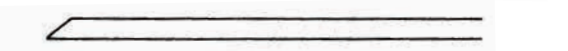
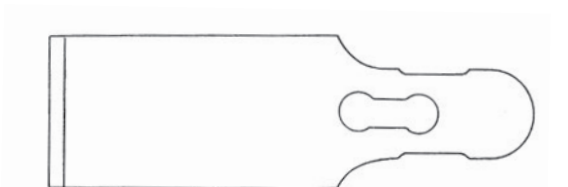

KM49664

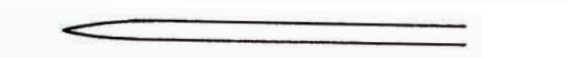
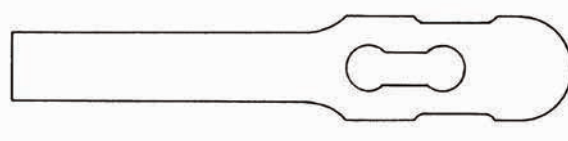

KM49672

ITEM #	DESCRIPTION
KM49630	Complete set with handle, key and all blades
KM49632	Phenolic handpiece only, 7-3/8" (18.5 cm)
KM49634	Key only
KM49668	Osteotome blade, 5 mm
KM49672	Osteotome blade, 10 mm
KM49676	Osteotome blade, 16 mm
KM49680	Osteotome blade, 25 mm
KM49652	Chisel blade, 5 mm
KM49656	Chisel blade, 10 mm
KM49660	Chisel blade, 16 mm
KM49664	Chisel blade, 25 mm
KM49640	Gouge blade, 1" wide, 50 mm radius
KM49644	Gouge blade, 1" wide, 60 mm radius
KM49648	Gouge blade, 1" wide, 70 mm radius

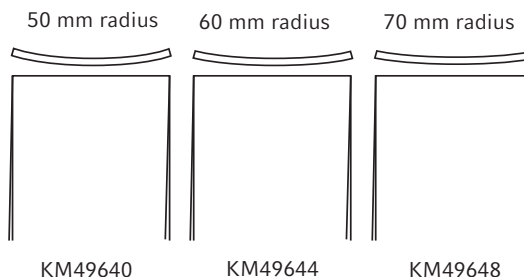

*Blades should be discarded after use.  
Phenolic handle is autoclavable to 290° F (143° C).*





# SMARTRACKS FOR OSTEOTOMES



## LIGHTWEIGHT RACKS FOR STERILIZATION AND STORAGE

- Nylon coated brackets help avoid metal-to-metal contact.
- Plastic plate on underside of top bracket helps protect sharp tips from being damaged.
- Side arm stays locked to help prevent instruments from falling out, even when turned upside down.
- Deep brackets hold instruments in place.
- Custom designed base keeps instruments upright during loading and unloading.
- Reinforced, sturdier frames are made from corrosion-resistant anodized aluminum.
- Fully autoclavable to 270°F/132°C.
- Quick reference chart easily identifies the type and size instrument rack holds.
- Manufactured only by Teleflex®.

### HOKE SMARTRACK

KM98150  
 8-1/4" x 5" x 2-1/4"  
 (21 cm x 12.5 cm x 5.5 cm)  
 Holds eight 5-1/4" (13.5 cm)

### LAMBOTTE SMARTRACK

KM98190  
 11-3/4" x 5-1/2" x 3-3/8"  
 (30 cm x 8.5 cm x 14 cm)  
 Holds twelve 9" (23 cm) KMedic® Lambotte Osteotomes







# CHISELS AND GOUGES

## Chisels

### ALEXANDER CHISELS



7-1/8" (18 cm).

KM49042

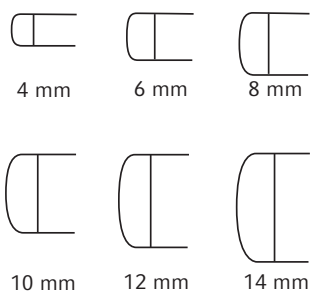
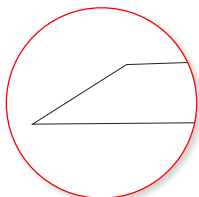

ITEM #	DESCRIPTION
KM49040	4 mm
KM49041	6 mm
KM49042	8 mm
KM49043	10 mm
KM49044	12 mm
KM49045	14 mm

### ARMY PATTERN CHISELS



7-1/8" (18 cm).

KM46289

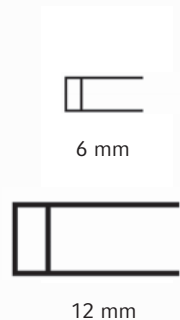
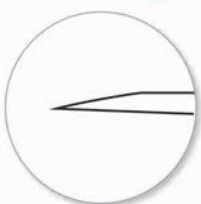

ITEM #	DESCRIPTION
KM46289	6 mm
KM46290	12 mm
KM46291	18 mm



# CHISELS AND GOUGES

## Chisels

### HIBBS CHISELS

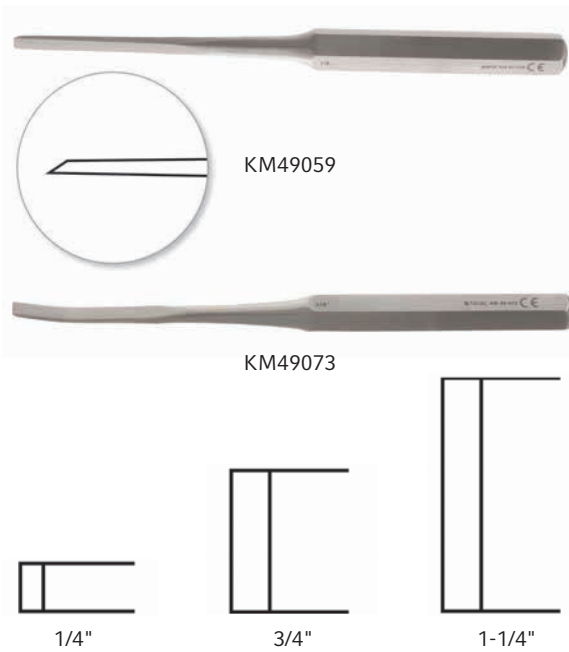

9" (23 cm).

ITEM #	TIP	TIP WIDTH
KM49059	Straight	1/4"
KM49060	Straight	3/8"
KM49061	Straight	1/2"
KM49062	Straight	5/8"
KM49063	Straight	3/4"
KM49064	Straight	7/8"
KM49065	Straight	1"
KM49066	Straight	1-1/8"
KM49067	Straight	1-1/4"
KM49068	Straight	1-1/2"
KM49073	Curved	1/4"
KM49074	Curved	3/8"
KM49075	Curved	1/2"
KM49076	Curved	5/8"
KM49077	Curved	3/4"
KM49078	Curved	7/8"
KM49079	Curved	1"
KM49080	Curved	1-1/8"
KM49081	Curved	1-1/4"
KM49082	Curved	1-1/2"

### HOKE CHISELS

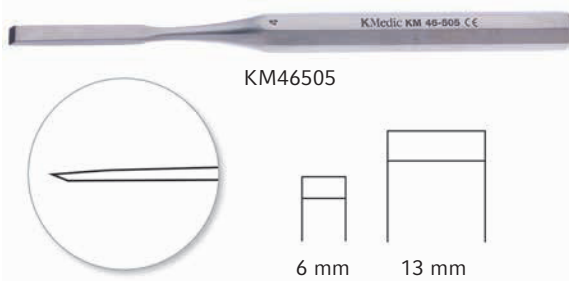

Straight, 5-1/4" (13.5 cm).

ITEM #	DESCRIPTION
KM46505	3/16" (4 mm)
KM46506	1/4" (6 mm)
KM46507	3/8" (10 mm)
KM46508	1/2" (13 mm)
KM46509	3/4" (19 mm)





# CHISELS AND GOUGES

## Chisels

### LEXER CHISELS

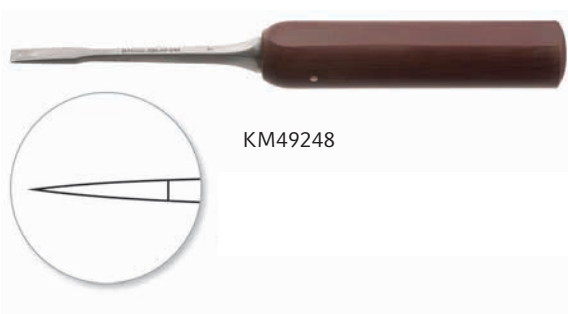

Phenolic handle, 8-5/8" (22 cm).

ITEM #	DESCRIPTION
KM49246	5 mm
KM49248	7 mm
KM49250	10 mm
KM49252	15 mm
KM49254	20 mm
KM49256	25 mm
KM49258	30 mm

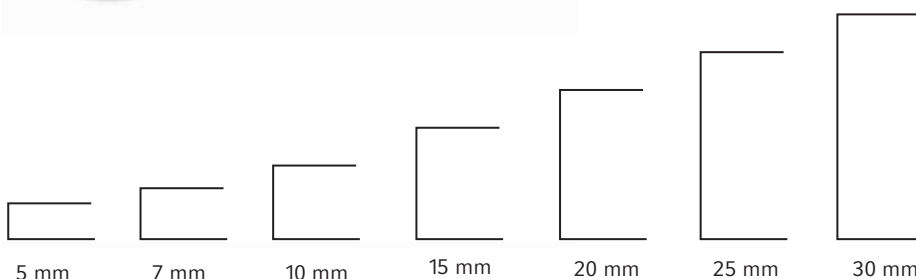

### LEXER MINI CHISELS



Phenolic handle, 7-1/8" (18 cm).

ITEM #	DESCRIPTION
KM49260	4 mm
KM49262	6 mm
KM49264	8 mm
KM49266	10 mm
KM49268	12 mm

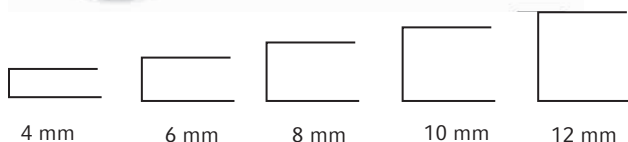

### STILLE-TYPE CHISELS



8-1/8" (20.5 cm).

ITEM #	DESCRIPTION
KM49010	10 mm
KM49012	14 mm
KM49014	18 mm
KM49016	22 mm





# CHISELS AND GOUGES

## Gouges

### ALEXANDER GOUGES



7" (18 cm).

ITEM #	DESCRIPTION
KM49050	4 mm
KM49051	6 mm
KM49052	8 mm
KM49053	10 mm
KM49054	12 mm
KM49055	14 mm

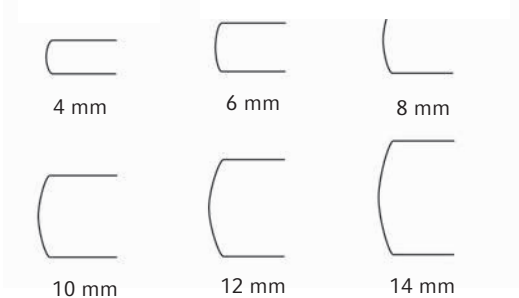

### U.S. ARMY PATTERN GOUGES



7" (18 cm).

ITEM #	DESCRIPTION
KM46292	6 mm
KM46293	12 mm
KM46294	14 mm

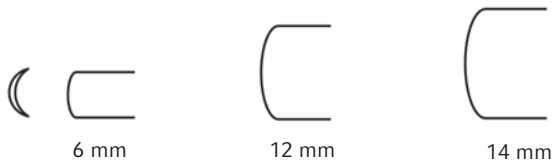



# CHISELS AND GOUGES

## Gouges

### STILLE-TYPE GOUGES



8" (20.5 cm).

ITEM #	DESCRIPTION
KM49018	10 mm
KM49020	14 mm
KM49022	18 mm
KM49024	22 mm

### SHOULDER PENETRATING GOUGE



ITEM #	DESCRIPTION
KM46919	3 mm tip, 8-1/2" (21.5 cm)

### SMITH PETERSON GOUGES

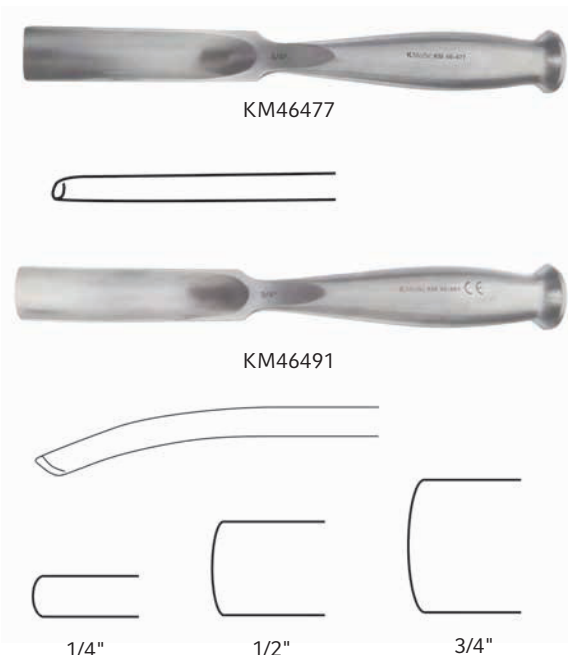

ITEM #	TIP	TIP WIDTH
KM46466	Straight	1/4"
KM46467	Straight	3/8"
KM46468	Straight	1/2"
KM46476	Straight	5/8"
KM46477	Straight	3/4"
KM46478	Straight	1"
KM46479	Straight	1-1/4"
KM46487	Curved	1/4"
KM46488	Curved	3/8"
KM46489	Curved	1/2"
KM46490	Curved	5/8"
KM46491	Curved	3/4"
KM46493	Curved	1"
KM46495	Curved	1-1/4"



# CHISELS AND GOUGES

## Gouges

### HIBBS GOUGES

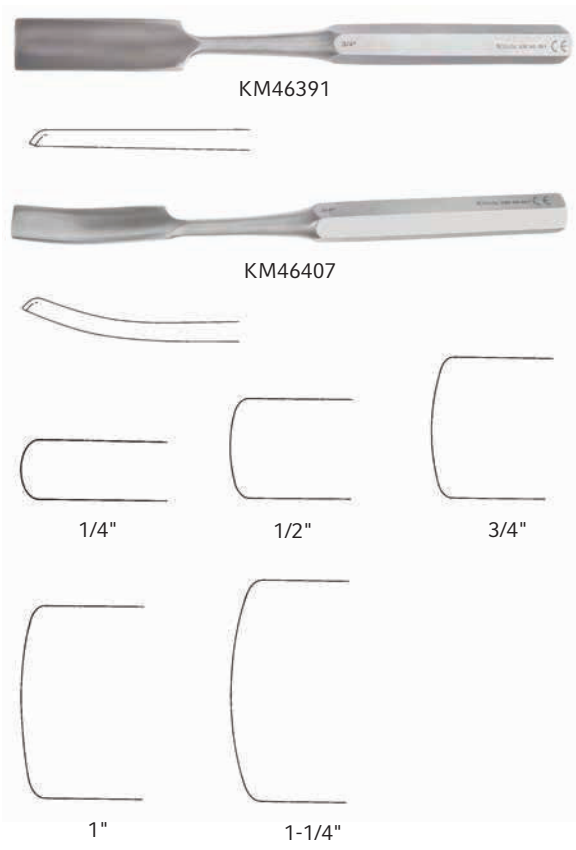

9" (23 cm).

ITEM #	TIP	TIP WIDTH
KM46387	Straight	1/4"
KM46388	Straight	3/8"
KM46389	Straight	1/2"
KM46390	Straight	5/8"
KM46391	Straight	3/4"
KM46392	Straight	7/8"
KM46393	Straight	1"
KM46394	Straight	1-1/8"
KM46395	Straight	1-1/4"
KM46401	Straight	1-1/2"
KM46402	Curved	1/4"
KM46403	Curved	3/8"
KM46404	Curved	1/2"
KM46405	Curved	5/8"
KM46407	Curved	3/4"
KM46408	Curved	7/8"
KM46409	Curved	1"
KM46410	Curved	1-1/8"
KM46411	Curved	1-1/4"
KM46412	Curved	1-1/2"

### SWAN NECK GOUGE

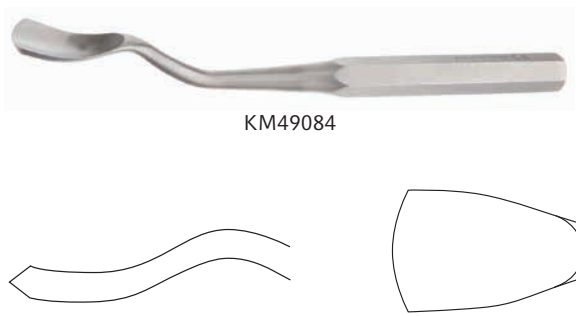

ITEM #	DESCRIPTION
KM49084	1" distal tip, 9" (23 cm)





# CHISELS AND GOUGES

## Gouges

### COBB-TYPE SPINAL GOUGES

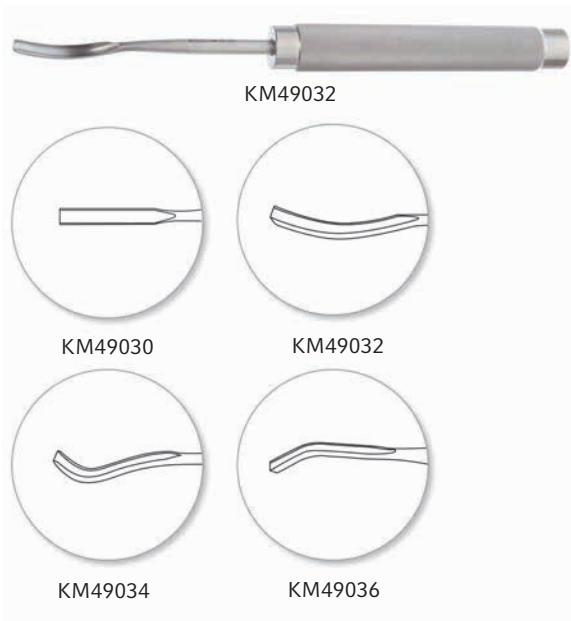

All stainless, with knurled handle, 5/32" (7 mm) distal tip, 11" (28 cm).

ITEM #	DESCRIPTION
KM49030	Straight
KM49032	Medium curve
KM49034	Strong curve
KM49036	Reverse curve

### HIBBS ENDOSCOPIC GOUGE



Straight tip, stainless steel handle, 18-1/2" (47 cm).

ITEM #	TIP WIDTH	TIP LENGTH	SHAFT LENGTH	SHAFT DIAMETER	HANDLE LENGTH
KM55630	0.28" (7 mm)	3-1/2"	10-3/4"	0.43"	4-1/4"



# BONE TAMPS AND IMPACTORS

## Bone Tamps

### BONE TAMPS

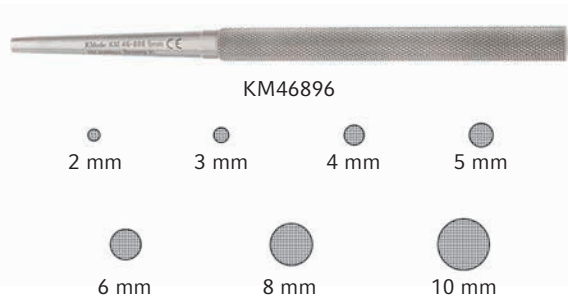

Cross-serrated tip, 6-1/4" (16 cm).

ITEM #	DESCRIPTION
KM46893	2 mm diameter
KM46894	3 mm
KM46895	4 mm
KM46896	5 mm
KM46897	6 mm
KM46898	8 mm
KM46899	10 mm

### BONE IMPACTOR



Designed to tap bone graft or bone parts into place with minimal trauma to the bone. The compactor head is nylon with a grid surface to prevent slippage.

ITEM #	DESCRIPTION
KM69980	Anodized aluminum handle with replaceable nylon caps, head diameter 20 mm, 6-1/2" (16.5 cm)

Autoclavable to 250°F (121°C)

### BONE CHIP PACKERS

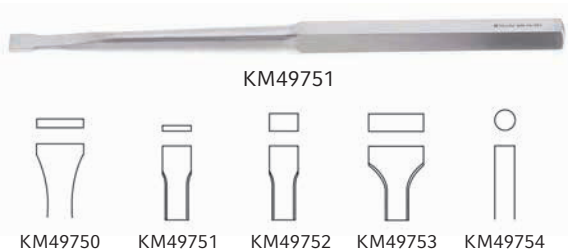

Stainless steel handle, 9-7/8" (25 cm).

ITEM #	DESCRIPTION
KM49750	3 mm x 16 mm
KM49751	2 mm x 9 mm
KM49752	6 mm x 9 mm
KM49753	6 mm x 19 mm
KM49754	1/4" (5 mm)





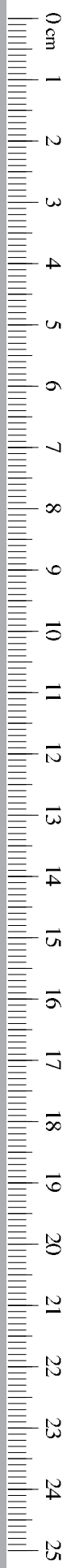

# BONE TAMPS AND IMPACTORS

## Impactors

### ENDOSCOPIC BONE TAMP



Straight, stainless steel handle, 17" (43 cm).

ITEM #	TIP WIDTH	TIP LENGTH	SHAFT LENGTH	SHAFT DIAMETER	HANDLE LENGTH
KM55676	3/8" (10 mm)	0.16"	12.59"	0.280" (7.1 mm)	4-1/4"

### LUMBAR AND CERVICAL IMPACTORS AND DRIVERS



KM55373

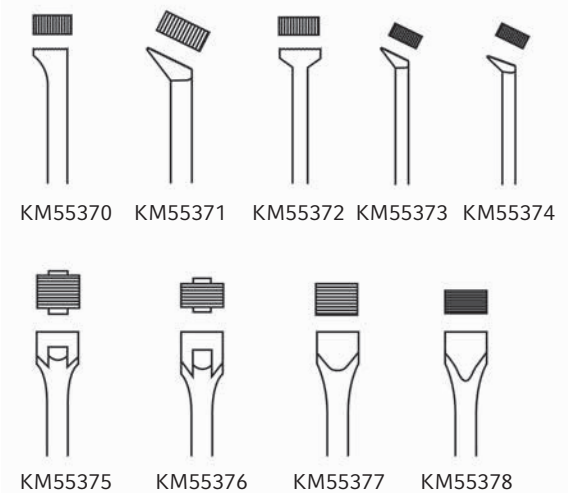

ITEM #	DESCRIPTION
KM55370	Impactor, standard offset, 6 mm x 12 mm, 8-1/2" (21.5 cm)
KM55371	Impactor, central canal, 7 mm x 16 mm, 8-1/2" (21.5 cm)
KM55372	Impactor, lateral narrow, 6 mm x 13 mm, 8-1/2" (21.5 cm)
KM55373	Impactor, micro offset, 4 mm x 9.5 mm, 7" (18 cm)
KM55374	Impactor, micro lateral, 4 mm x 10 mm, 7" (18 cm)
KM55375	Graft driver, lumbar, guarded, 10 mm x 13 mm, 8-1/2" (21.5 cm)
KM55376	Graft driver, anterior, guarded, 7 mm x 13 mm, 8-1/2" (21.5 cm)
KM55377	Graft driver, lumbar, unguarded, 10 mm x 13 mm, 8-1/2" (21.5 cm)
KM55378	Graft driver, anterior, unguarded, 7 mm x 13 mm, 8-1/2" (21.5 cm)



# MALLETS

## Light and Medium Weight Mallets

### NARROW TIP MALLET



KM49764

Useful for hand surgery and in areas where access is limited.

ITEM #	WEIGHT	HEAD WEIGHT	HEAD DIAMETER	OVERALL LENGTH
KM49764	7 oz. (198 g.)	3 oz. (85 g.)	18 x 18 mm (square contact surface) 7 mm (round contact surface)	8" (20.5 cm)

Autoclavable to 290°F (143°C)

### SOLID COPPER HEAD MALLET



051510

ITEM #	WEIGHT	HEAD DIAMETER	OVERALL LENGTH
051510	4 oz. (113 g.)	3/4" (20 mm)	6-1/2" (16.5 cm)

### MINI MALLET



KM49765

Solid stainless steel.

ITEM #	WEIGHT	HEAD WEIGHT	HEAD DIAMETER	OVERALL LENGTH
KM49765	4 oz. (113 g.)	3 oz. (85 g.)	20 mm	7" (18 cm)





# MALLETS

## Light and Medium Weight Mallets

### LUCAE BONE MALLETS



Solid stainless steel handles.

ITEM #	WEIGHT	HEAD	HEAD WEIGHT	HEAD DIAMETER	OVERALL LENGTH
KM49761	7 oz. (198 g.)	Stainless steel	3 oz. (85 g.)	19 mm	7-1/2" (19 cm)
KM46660	9 oz. (260 g.)	Brass	5 oz. (142 g.)	25 mm	8" (20.5 cm)

### MALLET #49



Lead filled and faced.

ITEM #	WEIGHT	HEAD WEIGHT	HEAD DIAMETER	OVERALL LENGTH
KM46656	7 oz. (198 g.)	5 oz. (142 g.)	22 mm	7-3/4" (19.5 cm)

*Lead filled mallets should only be used to strike flat surfaces. Do not use to hit sharp objects as doing so can lead to flake off.*

### MALLET



Lightweight. Includes two replaceable nylon caps, anodized aluminum handle.

ITEM #	WEIGHT	HEAD WEIGHT	HEAD DIAMETER	OVERALL LENGTH
KM46662	7 oz. (198 g.)	4 oz. (113 g.)	25 mm	7-1/2" (19 cm)

*Autoclavable to 250°F (121°C)*

### MALLET CAPS



ITEM #	DESCRIPTION
KM46662P	Pair of nylon caps for KM46662, 1" (2.5 cm)



# MALLETS

## Light and Medium Weight Mallets

### NYLON HEAD MALLETS



ITEM #	WEIGHT	HEAD DIAMETER	OVERALL LENGTH
051520	8 oz. (227 g.)	1" (25 mm)	7-1/2" (19 cm)
051525	11 oz. (312 g.)	1-1/4" (32 mm)	7-5/8" (19.5 cm)

### NYLON HEAD MALLET FACES



051526

ITEM #	DESCRIPTION
051521	Extra 1" nylon face for 051520
051526	Extra 1-1/2" nylon face for 051525

### COLLIN MALLET



KM49760

Solid stainless steel.

ITEM #	WEIGHT	HEAD WEIGHT	HEAD DIAMETER	OVERALL LENGTH
KM49760	7 oz. (198 g.)	5 oz. (142 g.)	30 mm	8" (20.5 cm)





# MALLETS

## Light and Medium Weight Mallets

### PECK MALLET



ITEM #	WEIGHT	OVERALL LENGTH
441420	7.7 oz. (218 g.)	7-7/8" (20 cm)

### MEAD MALLET

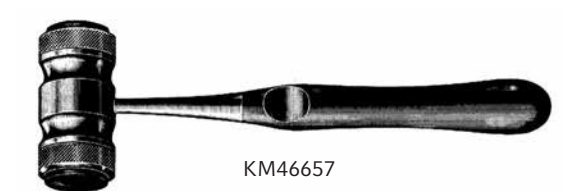

Includes replaceable nylon caps.

ITEM #	WEIGHT	HEAD WEIGHT	HEAD DIAMETER	OVERALL LENGTH
KM46657	11 oz. (315 g.)	6 oz. (170 g.)	20 mm	7-1/2" (19 cm)

Autoclavable to 250 °F (121 °C)

### GERZOG BONE MALLET



Lead filled and faced.

ITEM #	WEIGHT	HEAD WEIGHT	HEAD DIAMETER	OVERALL LENGTH
KM46661	10 oz. (285 g.)	7 oz. (200 g.)	25 mm	7-1/2" (19 cm)

Lead filled mallets should only be used to strike flat surfaces. Do not use to hit sharp objects as doing so can lead to flake off.





# MALLETS

## Light and Medium Weight Mallets

### BERGMAN MALLETS



Aluminum alloy handle.

ITEM #	WEIGHT	HEAD WEIGHT	HEAD DIAMETER	OVERALL LENGTH
KM49766	15 oz. (425 g.)	9 oz. (255 g.)	30 mm	8-7/8" (22.5 cm)
KM49767	1 lb. 1 oz. (482 g.)	11 oz. (312 g.)	45 mm	9-1/2" (24 cm)

### COMBINATION MALLETS



With one nylon cap and one solid stainless side.

ITEM #	WEIGHT	HEAD WEIGHT	HEAD DIAMETER	OVERALL LENGTH
KM46686	9 oz. (260 g.)	5 oz. (142 g.)	25 mm	7-1/2" (19 cm)
KM46687	12 oz. (340 g.)	8 oz. (227 g.)	32 mm	7-1/2" (19 cm)

Autoclavable to 250°F (121°C)

### COMBINATION Mallet CAPS



KM46687P

With one nylon cap and one solid stainless side.

ITEM #	DESCRIPTION
KM46686P	Nylon cap for KM46686, 1" (2.5 cm)
KM46687P	Nylon cap for KM46687, 1-1/4" (3.2 cm)





# MALLETS

## Light and Medium Weight Mallets

### CLOWARD-STYLE MALLETS



Solid stainless steel.

ITEM #	WEIGHT	HEAD WEIGHT	HEAD DIAMETER	BALL PEEN DIAMETER	OVERALL LENGTH
KM55400	8 oz. (227 g.)	4 oz. (113 g.)	20.5 mm	17.5 mm	7-1/2" (19 cm)
KM55401	16 oz. (454 g.)	8 oz. (227 g.)	25 mm	22 mm	9" (23 cm)

### ORTHOPEDIC MALLETS



Solid stainless steel.

ITEM #	HANDLE LENGTH	WEIGHT	HEAD WEIGHT	HEAD DIAMETER	OVERALL LENGTH
KM49763	Short	1 lb. 2 oz. (510 g.)	8 oz. (227 g.)	30.5 mm	7" (18 cm)
KM46666	Normal	2 lbs. (900 g.)	1 lb. (455 g.)	32 mm	10-3/4" (27.5 cm)



# MALLETS

## Heavyweight Mallets

### KIRK MALLET



Brass filled with stainless steel face.

ITEM #	WEIGHT	HEAD WEIGHT	HEAD DIAMETER	OVERALL LENGTH
KM46658	1 lb. 7 oz. (650 g.)	1 lb. 4 oz. (570 g.)	38 mm	8" (20.5 cm)

Head is brass filled and should only be used to strike flat surfaces.

### HEATH MALLET



Heavyweight, solid stainless steel.

ITEM #	WEIGHT	HEAD WEIGHT	HEAD DIAMETER	OVERALL LENGTH
KM46663	2 lbs. (907 g.)	1 lb. 4 oz. (570 g.)	40 mm	7-1/2" (19 cm)

### ORTHOPEDIC MALLETS



Solid stainless steel.

ITEM #	HANDLE LENGTH	WEIGHT	HEAD WEIGHT	HEAD DIAMETER	OVERALL LENGTH
KM49762	Short	2 lbs. (900 g.)	1 lb. 5 oz. (595 g.)	38 mm	7-1/2" (19 cm)
KM46667	Normal	3 lbs. (1360 g.)	2 lbs. (900 g.)	50 mm	11" (28 cm)







# MALLETS

## Heavyweight Mallets

### PHENOLIC HANDLE MALLETS



Grooved phenolic handle for comfortable and safe grip.

ITEM #	WEIGHT	HEAD WEIGHT	HEAD DIAMETER	OVERALL LENGTH
KM46688	1 lb. 11 oz. (765 g.)	1 lb. (455 g.)	32 mm	11" (28 cm)
KM46689	2 lbs. 9 oz. (1162 g.)	2 lbs. (900 g.)	45 mm	11" (28 cm)

Autoclavable to 290°F (143°C)

### REPROCUSSION FREE MALLET



Also known as a dead blow mallet. One nylon cap and one stainless steel side. Grooved phenolic handle for comfortable grip.

ITEM #	WEIGHT	HEAD WEIGHT	HEAD DIAMETER	OVERALL LENGTH
KM46690	1 lb. 5 oz. (600 g.)	10 oz. (285 g.)	30 mm	11" (28 cm)

Autoclavable to 250°F (121°C)

### REPROCUSSION FREE MALLET CAP



ITEM #	DESCRIPTION
KM46690P	Cap only for KM46690



# BONE CUTTING FORCEPS

## CLEVELAND BONE CUTTING FORCEPS



For small bones.

ITEM #	DESCRIPTION
KM47270	5-3/4" (15 cm)
KM47272	6-1/2" (17 cm)

## MCINDOE BONE CUTTING FORCEPS



ITEM #	DESCRIPTION
KM47546	Angled, very delicate, 7" (18 cm)

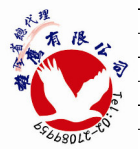



# BONE CUTTING FORCEPS

## LISTON BONE CUTTING FORCEPS



KM47402

ITEM #	DESCRIPTION
KM47398	Straight, 5-1/2" (14 cm)
KM47410	Angled on flat, 5-1/2" (14 cm)
KM47400	Straight, 6-3/4" (17 cm)
KM47404	Angled on flat, 6-3/4" (17 cm)
KM47402	Straight, 7-7/8" (20 cm)
KM47412	Angled, 7-7/8" (20 cm)
KM47406	Straight, 8-5/8" (22 cm)
KM47408	Angled on flat, 8-1/2" (22 cm)

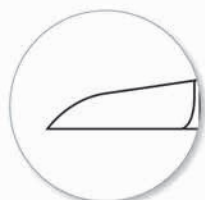

KM47398



KM47410

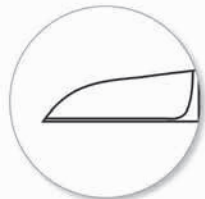

KM47400



KM47404

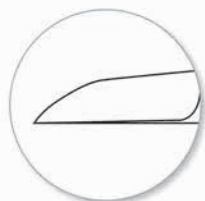

KM47402



KM47412

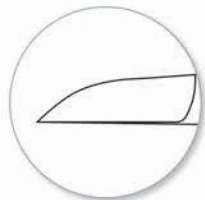

KM47406



KM47408





# BONE CUTTING FORCEPS

## RUSKIN-LISTON BONE CUTTING FORCEPS

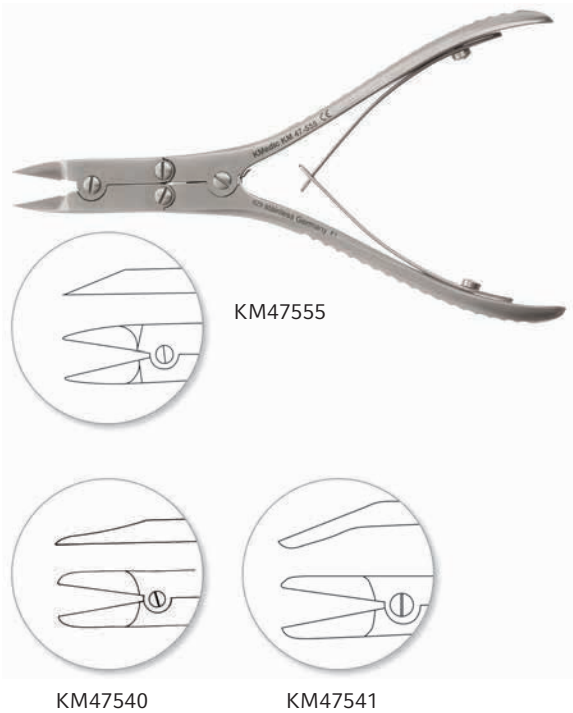

Delicate blades.

ITEM #	DESCRIPTION
KM47555	Straight, 5-5/8" (15 cm)
KM47557	Angled, 5-1/2" (14 cm)
KM47540	Straight, 7-1/8" (18 cm)
KM47541	Angled on flat, 7" (18 cm)

## STILLE-LISTON BONE CUTTING FORCEPS

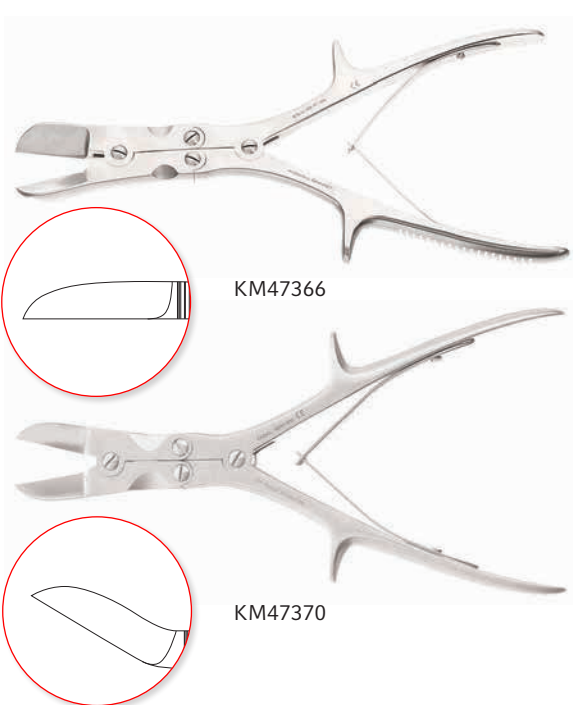

10-1/2" (27 cm).

ITEM #	DESCRIPTION
KM47366	Straight
KM47370	Angled on flat





# BONE CUTTING FORCEPS

## RUSKIN-LISTON BONE CUTTING FORCEPS

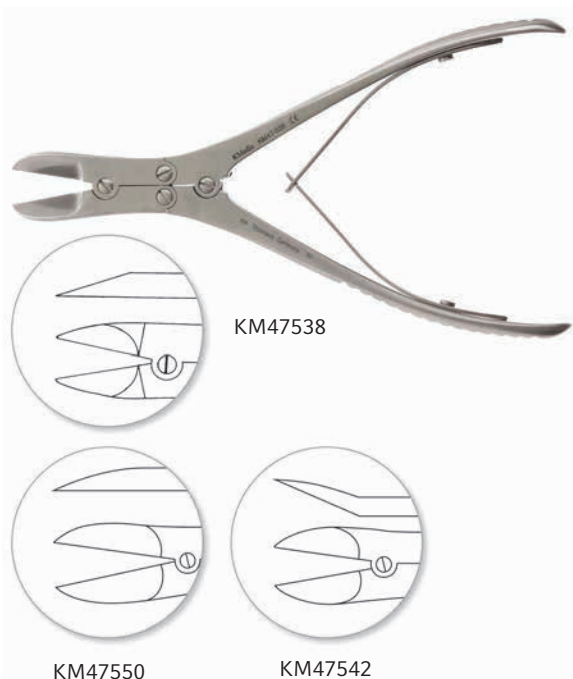

ITEM #	DESCRIPTION
KM47550	Straight, 6" (15 cm)
KM47538	Straight, 7-1/4" (19 cm)
KM47542	Angled, 7-1/4" (19 cm)

## STILLE-HORSLEY BONE CUTTING FORCEPS



ITEM #	DESCRIPTION
KM47374	Angled, 9-3/8" (24 cm)





# RONGEURS

Single Action Design

## SYNOVECTOMY RONGEURS



2 x 5 mm bite, extremely delicate.

ITEM #	DESCRIPTION
KM47252	Slightly curved, 6-7/8" (17.5 cm)
KM47253	Strongly curved, 6-3/4" (17 cm)

## RONGEUR #4



ITEM #	DESCRIPTION
KM47274	Curved, 4 x 9 mm bite, 5-1/2" (14 cm)

## RONGEUR #4A

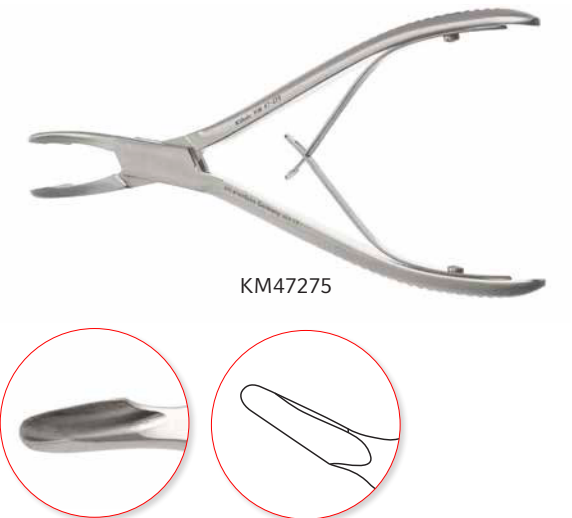

ITEM #	DESCRIPTION
KM47275	Curved, 4 x 7 mm bite, 6-1/2" (16.5 cm)





# RONGEURS

## Single Action Design

### RONGEUR #10 (1A)

ITEM #	DESCRIPTION
KM47296	6-1/2" (16.5 cm)

### MICRO FRIEDMAN RONGEURS



1.5 x 5 mm bite. For soft tissue and cancellous bone only. Extremely delicate.

ITEM #	DESCRIPTION
KM47240	Straight, 5-3/4" (14.5 cm)
KM47242	30 degree angled, 5-1/2" (14 cm)
KM47244	90 degree angled, 5-1/2" (14 cm)



# RONGEURS

Single Action Design

## MINI FREIDMAN FONGEURS

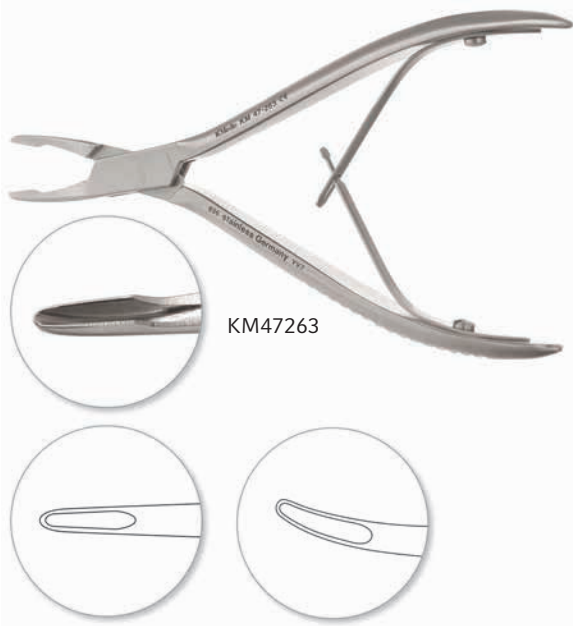

KM47263

KM47263

KM47264

Delicate, 2 x 8 mm bite, 6" (15 cm).

ITEM #	DESCRIPTION
KM47263	Straight
KM47264	Curved

## FRIEDMAN RONGEUR



KM47262

ITEM #	DESCRIPTION
KM47262	Curved, delicate, 4 x 11 mm bite, 5-3/4" (14.5 cm)







# RONGEURS

Single Action Design

## KLEINERT-KUTZ SYNOVECTOMY RONGEUR



ITEM #	DESCRIPTION
065202	25 degrees strongly curved, 5-1/4" (13.5 cm)

## BANE RONGEUR



ITEM #	DESCRIPTION
KM47310	Curved, 3 x 16 mm bite, 7" (18 cm)





# RONGEURS

Single Action Design

## DEAN RONGEUR



ITEM #	DESCRIPTION
KM47286	Curved, 3 mm bite, 5-3/4" (14.5 cm)

## CHICHIRELLI (BLUMENTHAL) RONGEUR



ITEM #	DESCRIPTION
KM47267	Curved 45 degrees, 4 x 13 mm bite, 6" (15 cm)





# RONGEURS

## Single Action Design

### BACON RONGEUR



ITEM #	DESCRIPTION
KM47308	Curved on side, 5 x 15 mm bite, 8" (20.5 cm)

### LEMPERT RONGEURS

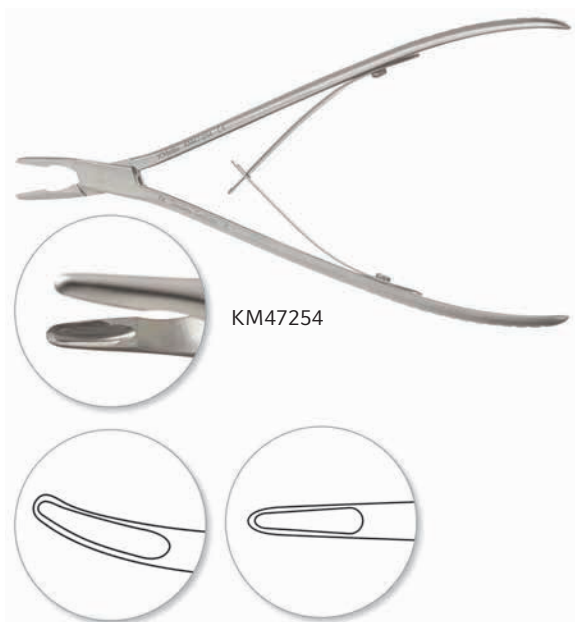

Delicate, 3 x 7 mm bite.

ITEM #	DESCRIPTION
KM47258	Straight, 6" (15 cm)
KM47260	Curved, 6" (15 cm)
KM47254	Straight, 7-1/2" (19 cm)
KM47256	Curved, 7-1/2" (19 cm)

KM47258

KM47260





# RONGEURS

Single Action Design

## BEYER BONE BITING RONGEUR



028120

ITEM #	DESCRIPTION
028120	Curved jaw, 16 x 3 mm cup, 6-3/4" (17 cm)

## DEAN (BLUMENTHAL) RONGEURS



KM47266

KM47268

4 x 11 mm, 6" (15 cm).

ITEM #	DESCRIPTION
KM47266	Curved 30 degrees
KM47268	Curved 90 degrees





# RONGEURS

## Single Action Design

### HARTMAN RONGEUR



ITEM #	DESCRIPTION
KM47285	Curved, 4 x 14 mm bite, 7-1/4" (18.5 cm)

### MEAD RONGEUR

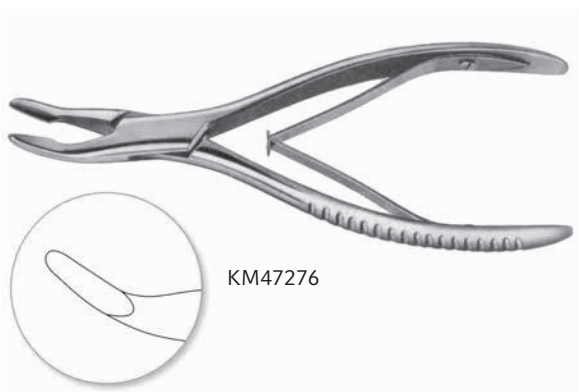

ITEM #	DESCRIPTION
KM47276	Curved, 5 x 13 mm bite, 6-1/2" (16.5 cm)





# RONGEURS

Single Action Design

## ADSON RONGEURS



7 x 15 mm bite, 8" (20.5 cm).

ITEM #	DESCRIPTION
KM47302	Straight
KM47306	Curved

## ADSON RAT TOOTH RONGEUR



Teeth facilitate easier bone excision.

ITEM #	DESCRIPTION
KM47304	Straight with teeth, 8 x 15 mm bite, 8" (20.5 cm)





# RONGEURS

Single Action Design

## LEUR RONGEURS



8 x 12 mm bite, 7-1/8" (18 cm).

ITEM #	DESCRIPTION
KM47278	Straight
KM47284	Curved

Double Action Design

## KLEINERT-KUTZ SYNOVECTOMY RONGEUR

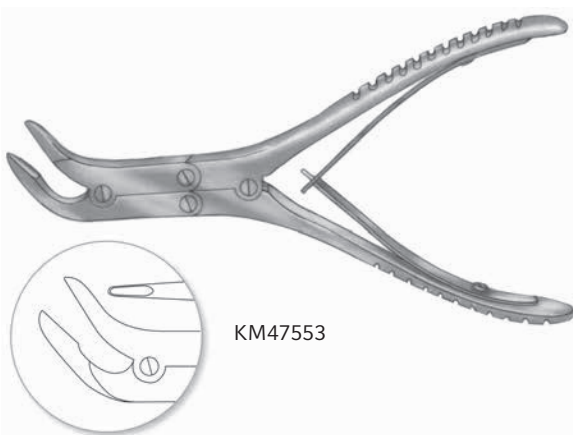

ITEM #	DESCRIPTION
KM47553	Curved on side, delicate, 2 x 10 mm bite, 6" (15 cm)



# RONGEURS

Double Action Design

## KLEINERT-KUTZ SYNOVECTOMY RONGEUR



ITEM #	DESCRIPTION
KM47558	Fully curved, delicate, 3 mm bite, 6-1/8" (15.5 cm)

## KLEINERT-KUTZ SYNOVECTOMY RONGEURS



Delicate, 6-1/8" (15.5 cm).

ITEM #	DESCRIPTION
KM47560	Curved, 2 mm bite
KM47562	Curved, 3 mm bite







# RONGEURS

## Double Action Design

### KLEINERT-KUTZ DOUBLE ACTION RONGEUR



ITEM #	DESCRIPTION
065212	10 degrees lightly curved, 18.5 x 5 mm cup, 7-1/4" (18.5 cm)

### BEYER RONGEURS



Curved, 7" (18 cm).

ITEM #	DESCRIPTION
KM47520	3 x 14 mm bite
KM47522	4 x 15 mm bite

KM47520

KM47522





# RONGEURS

Double Action Design

## RUSKIN RONGEURS

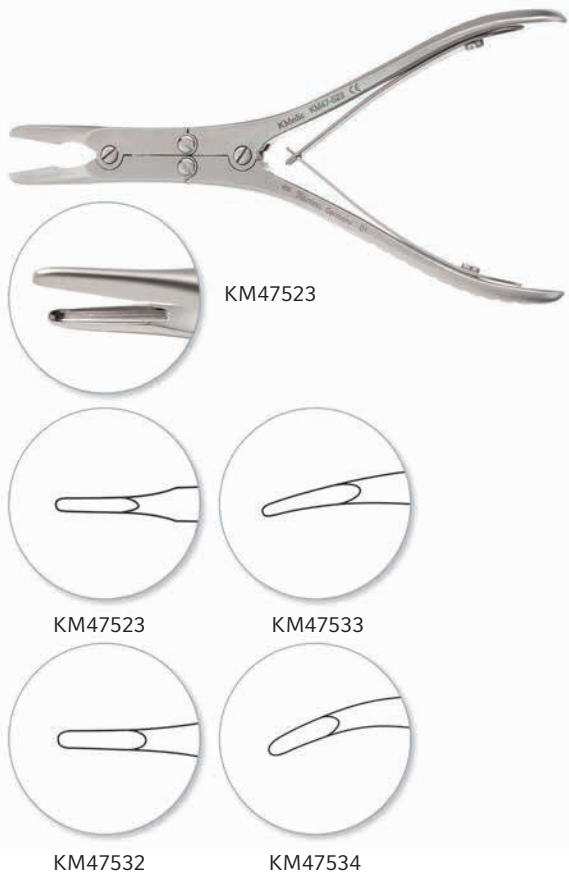

6" (15.5 cm).

ITEM #	DESCRIPTION
KM47523	Straight, 2 x 14 mm bite
KM47532	Straight, 3 x 15 mm bite
KM47533	Curved, 2 x 15 mm bite
KM47534	Curved, 3 x 15 mm bite

## RUSKIN RONGEURS

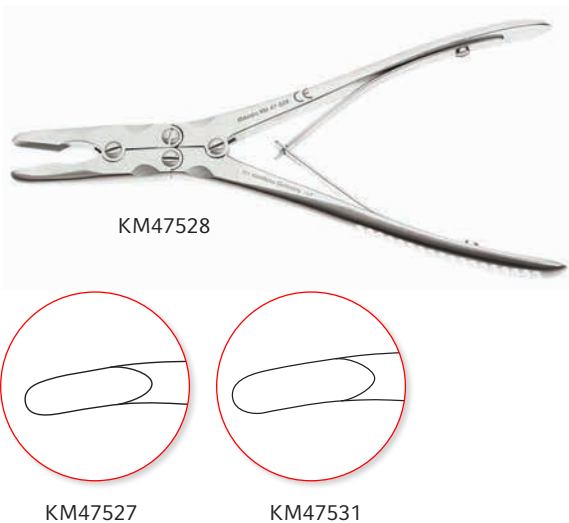

7-1/4" (18.5 cm).

ITEM #	DESCRIPTION
KM47526	Straight, 4 x 16 mm bite
KM47527	Curved, 4 x 16 mm bite
KM47528	Straight, 6 x 16 mm bite
KM47531	Curved, 6 x 16 mm bite





# RONGEURS

Double Action Design

## RUSKIN RONGEUR

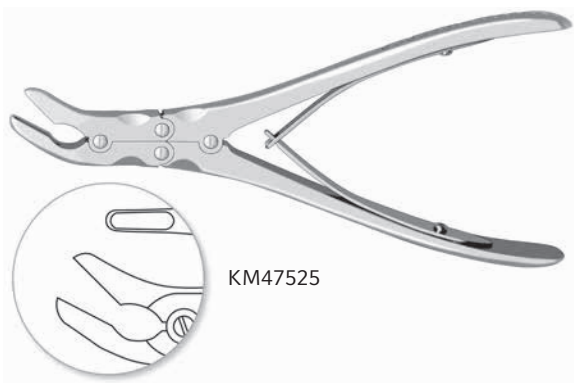

KM47525

ITEM #	DESCRIPTION
KM47525	Curved, 5 x 10 mm bite, 7-1/4" (18.5 cm)

## PILLING RUSKIN RONGEUR



341836

ITEM #	DESCRIPTION
341836	Double action, curved, 4 mm bite, 6-1/8" (15.5 cm)





# RONGEURS

Double Action Design

## ZAUFAL-JANSEN RONGEUR



ITEM #	DESCRIPTION
KM47524	Curved, 5 x 15 mm bite, 7" (18 cm)

## SMITH-PETERSEN LAMINECTOMY RONGEUR



ITEM #	DESCRIPTION
386152	Double action, curved 15 degrees, 7-1/2" (19 cm)





# RONGEURS

Double Action Design

## SMITH-PETERSON LAMINECTOMY RONGEURS

3 x 16 mm bite, 9-1/2" (24 cm).

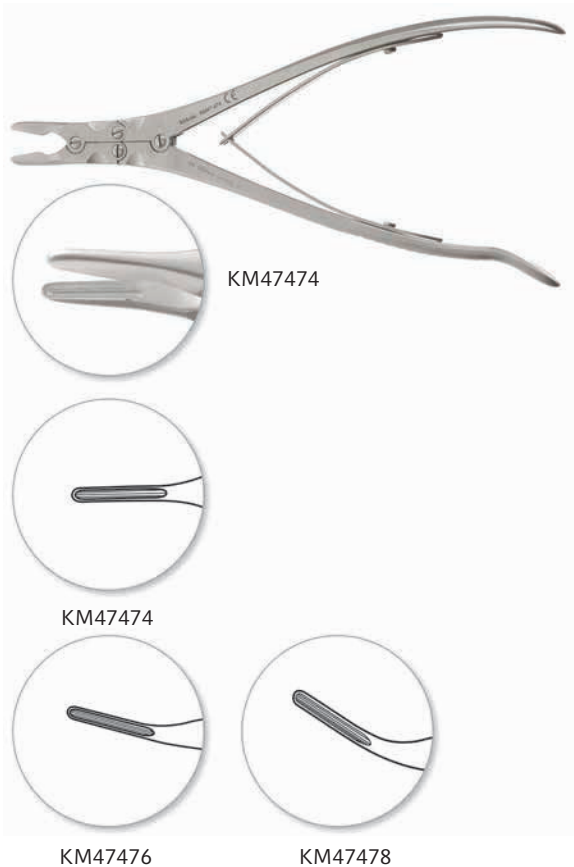

ITEM #	DESCRIPTION
KM47474	Straight
KM47476	Curved
KM47478	Full curved



# RONGEURS

Double Action Design

## LEKSELL RONGEURS

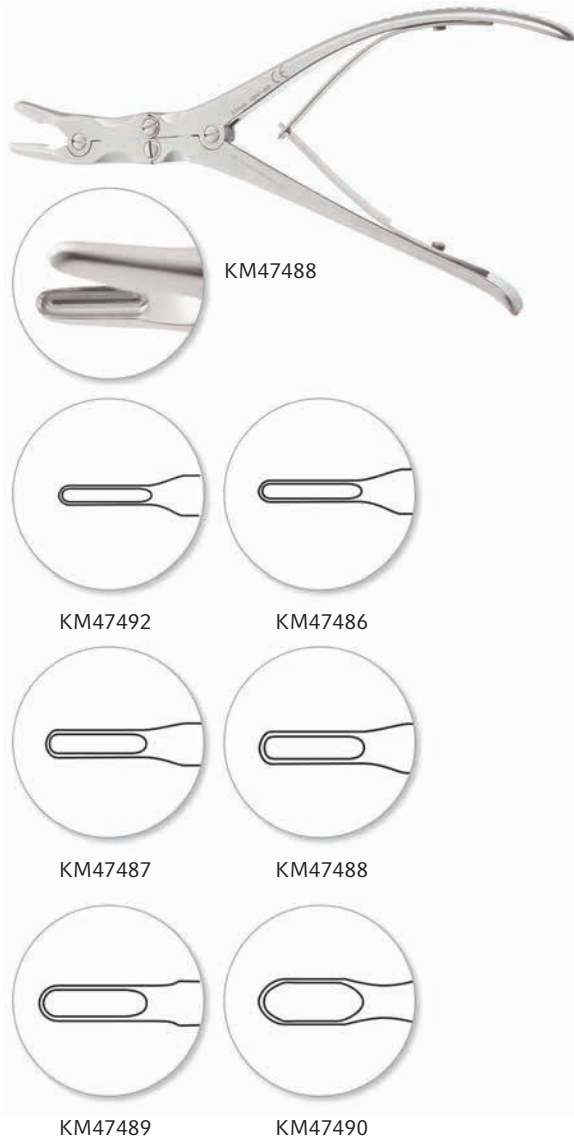

Curved 15 degrees, 9" (23 cm).

ITEM #	DESCRIPTION
KM47492	3 x 16 mm bite
KM47486	4.5 x 16 mm bite
KM47487	5 x 16 mm bite
KM47488	6 x 16 mm bite
KM47489	7 x 16 mm bite
KM47490	8 x 16 mm bite





# RONGEURS

## Double Action Design

### LEKSELL RONGEURS

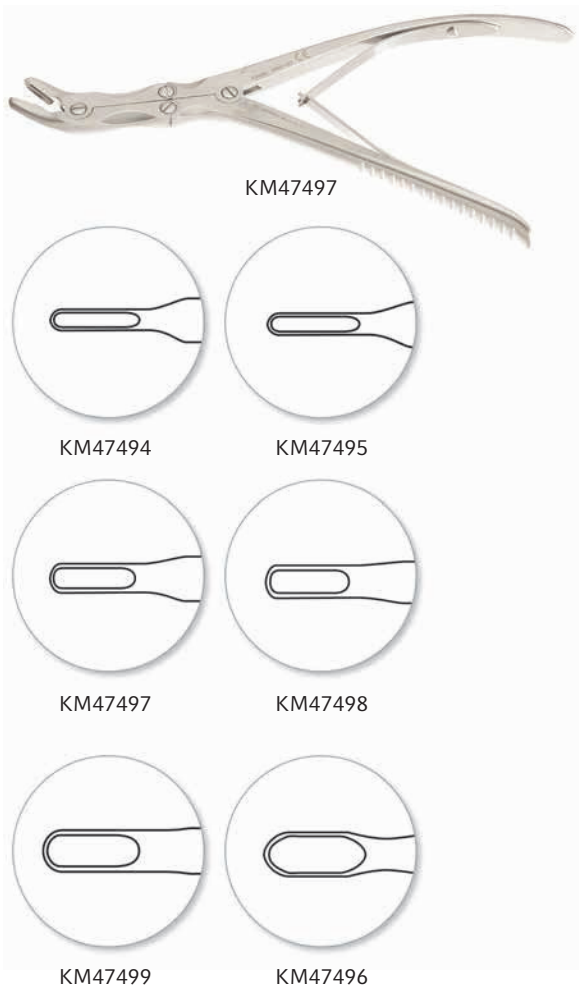

Curved 50 degrees, 9-1/2" (24 cm).

ITEM #	DESCRIPTION
KM47494	3 x 13 mm bite
KM47495	4 x 13 mm bite
KM47497	5 x 13 mm bite
KM47498	6 x 13 mm bite
KM47499	7 x 13 mm bite
KM47496	8 x 16 mm bite



# RONGEURS

Double Action Design

## ECHLIN DUCKBILL RONGEURS

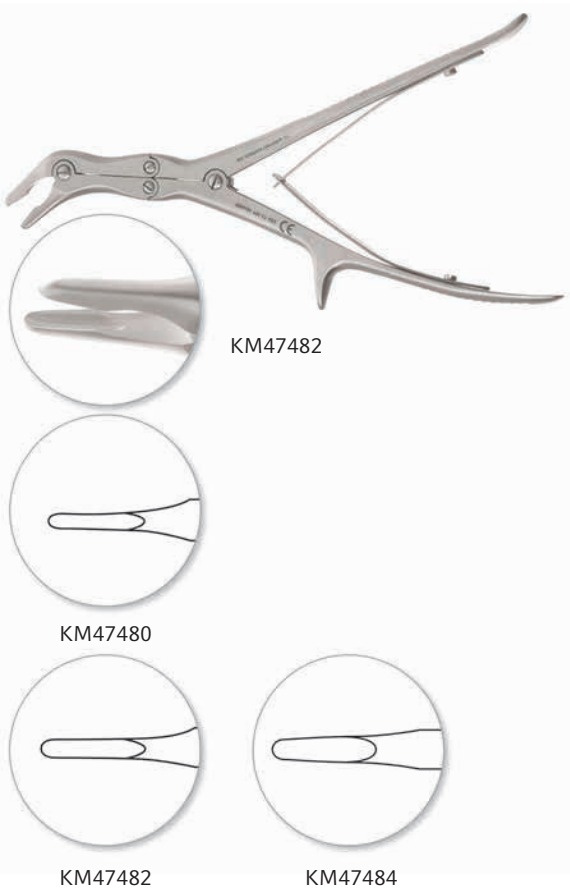

Curved on side, 9" (23 cm).

ITEM #	DESCRIPTION
KM47480	2 x 12 mm bite
KM47482	3 x 12 mm bite
KM47484	4 x 12 mm bite







# RONGEURS

Double Action Design

## STILLE-LUER ECHLIN DUCKBILL RONGEURS



Curved on side, 9" (23 cm).

ITEM #	DESCRIPTION
KM47472	6 x 13 mm bite
KM47473	6 x 15 mm bite





# RONGEURS

Double Action Design

## STILLE-LEUR RONGEURS

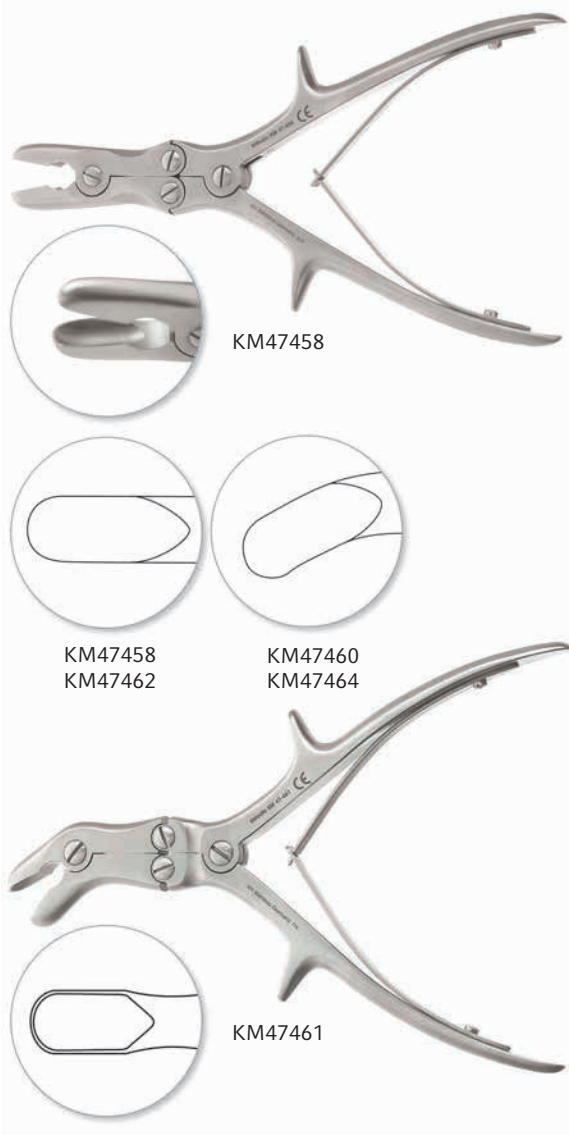

ITEM #	DESCRIPTION
KM47458	Straight, 10 x 18 mm, 8-1/2" (21.5 cm)
KM47462	Straight, 10 x 18 mm, 10-1/2" (26.5 cm)
KM47460	Curved, 10 x 18 mm, 8-3/8" (21 cm)
KM47464	Curved, 10 x 18 mm, 10-1/2" (26.5 cm)
KM47461	Curved on side, 10 x 16 mm, 8-1/2" (21.5 cm)

KM47458

KM47458  
KM47462

KM47460  
KM47464

KM47461





# RONGEURS

Double Action Design

## SYPERT RONGEURS

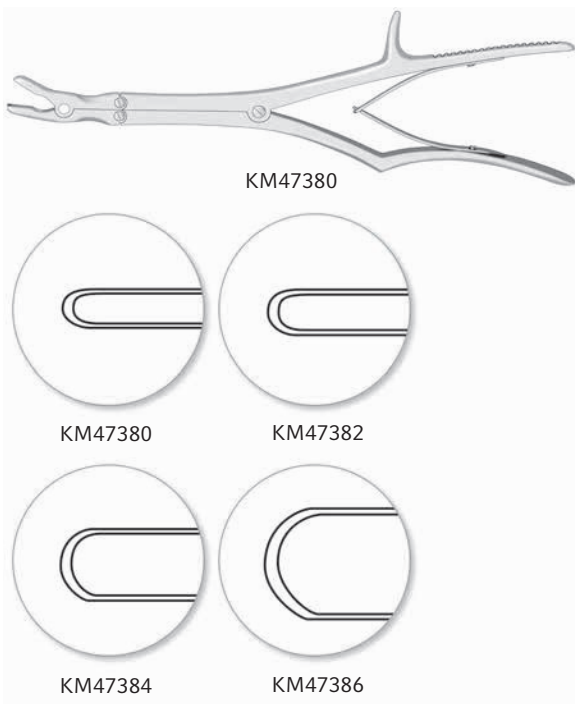

14" (35.5 cm).

ITEM #	DESCRIPTION
KM47380	4 x 16 mm
KM47382	5 x 16 mm
KM47384	8 x 16 mm
KM47386	12 x 16 mm



# KMEDIC® SPINAL RONGEURS AND PUNCHES

SHAFT LENGTH *measured in closed position*



## IDENTIFICATION CHART

### BITE STYLES *punch jaws, thin footplate*

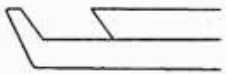

Forward 40°

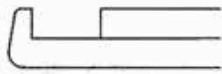

Up 90°

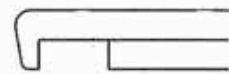

Down 90°

### BITE STYLES *punch jaws, regular footplate*



Forward 40°

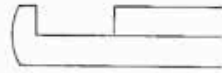

Up 90°

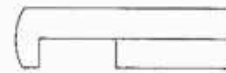

Down 90°

### BITE STYLES *cup jaws*



Straight



Up



Down

### PUNCH JAWS



Foot plate



Bite opening

Bite size



Bite size is etched on handles of spinal rongeurs and punches





# Handle Styles

**STYLE I**  
Ring Handle  
Handle Height 4"



**STYLE II**  
Kerrison Handle  
Handle Height 6-1/4"



**STYLE III**  
Love-Kerrison Handle  
(Cherry)  
Handle Height 6"



**STYLE IV**  
Large Kerrison Handle  
Handle Height 6-1/4"



**STYLE V**  
Small Kerrison Handle  
Handle Height 5"



**STYLE VI**  
Ferris-Smith  
Herrison Ring Handle  
Handle Height 5"



**STYLE VII**  
Spurling Kerrison Handle  
Handle Height 4-3/4"  
Wider grip improves  
comfort and control.

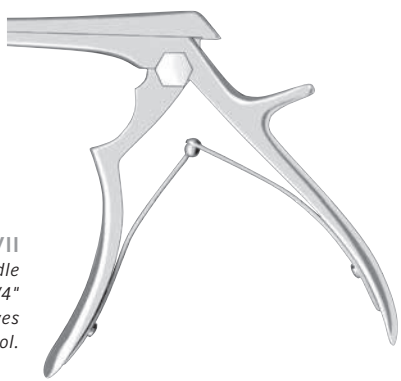

**STYLE VIII**  
Medium Kerrison Handle  
Handle Height 5-1/4"



All KMedic® Spinal Rongeurs and Punches have bite size etched on handles for easy identification



# KMEDIC® CLEANPUNCH® RONGEURS

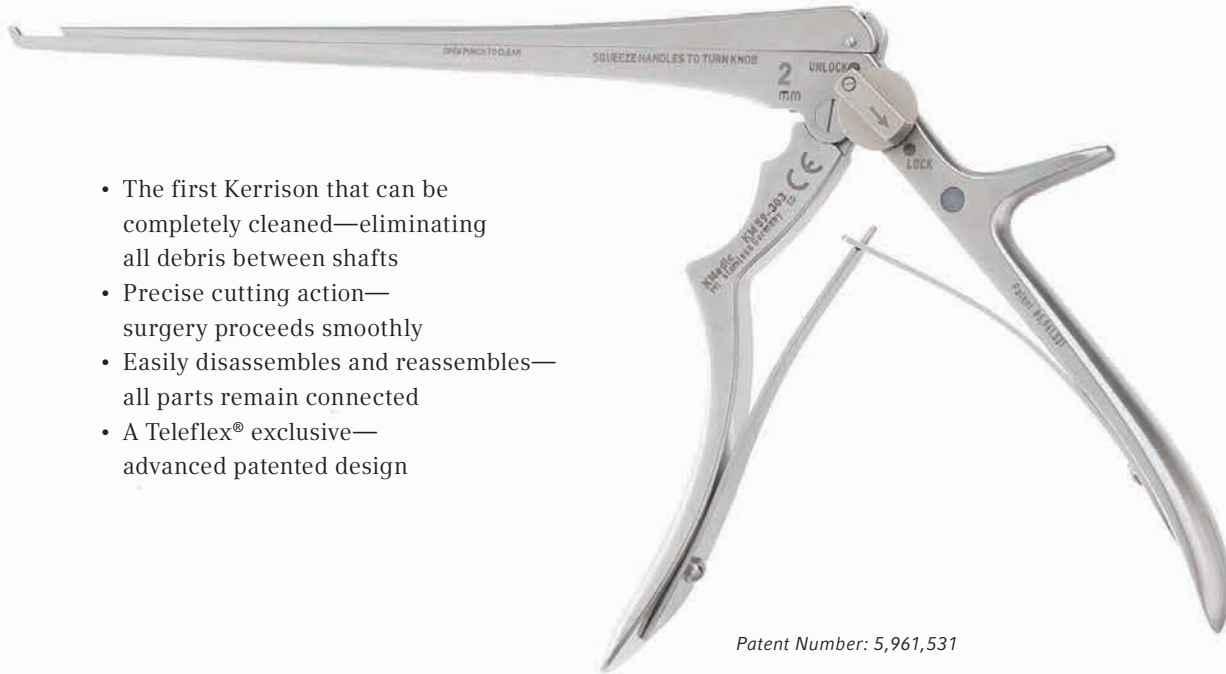

Patent Number: 5,961,531

- The first Kerrison that can be completely cleaned—eliminating all debris between shafts
- Precise cutting action—surgery proceeds smoothly
- Easily disassembles and reassembles—all parts remain connected
- A Teleflex® exclusive—advanced patented design

In most punches, tissue and debris can be trapped between the top and bottom shafts. This “buildup” is not only unsanitary, but adversely affects the functioning of the instruments, which slows down procedures and can distract the surgeon. This problem caused by the common punch design, which does not allow parts to be disassembled and properly cleaned.

The KMedic® CleanPunch® Rongeur is the first Kerrison that easily disassembles and reassembles to ensure surgeons benefit from a clean, smooth cutting action. The product of fine craftsmanship and superior technology, the CleanPunch® Rongeur — like all KMedic® Certified Instruments—is designed and manufactured to perform impeccably.

## COMPLETELY CLEAN

With total access to the top shaft, debris is quickly removed. Cleaning requires no scraping or “excavating”, which can damage an instrument and delay surgery.

## SIMPLE TO OPEN AND CLOSE

To open, simply turn knob arrow to “open” and pull back the top slider. To close, align top slider and bottom shaft, push slider forward, and turn knob arrow back to “close”.

## REMAINS IN ONE PIECE

The KMedic® CleanPunch® Rongeur remains in one piece throughout disassembly and reassembly. Patented design ensures there’s no possibility of losing or switching parts.

## ERGONOMIC DESIGN

The custom-designed handle has a wider grip for optimum control and comfort. In addition, it reduces fatigue and enhances concentration.

## GREATER FLEXIBILITY

The CleanPunch® Rongeur is available in 7” and 8” shaft lengths with regular and thin footplates, from 1 mm to 5 mm bites.

## A TELEFLEX® EXCLUSIVE

The patented CleanPunch® Rongeur conforms to the exacting standards that distinguish all KMedic® Certified Instruments.





# KMEDIC® CLEANPUNCH® RONGEUR

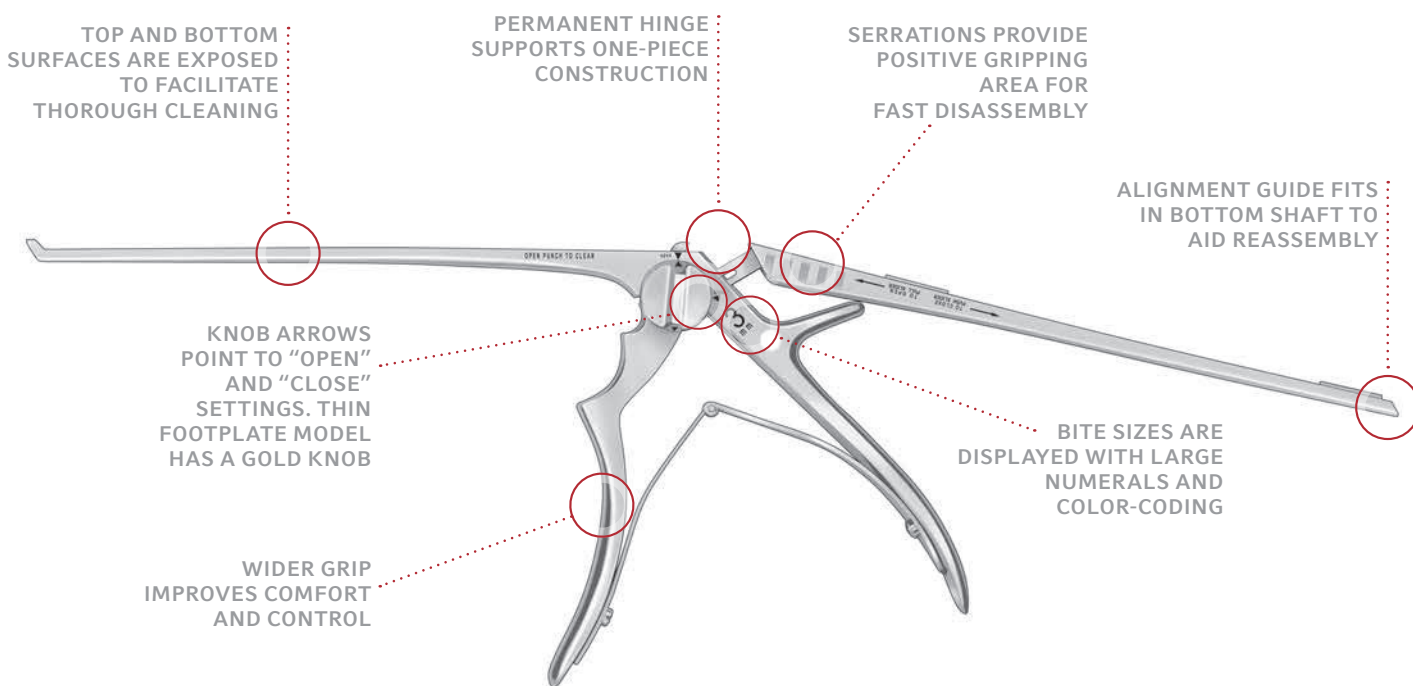

## FEATURES AND BENEFITS:

- Patented design enables the instrument to be completely cleaned, eliminating the "buildup" of bone, tissue and fluids that cause sticking and resistance to action.
- Provides a consistently smooth cutting action.
- Eliminates distractions that interrupt a surgeon's concentration required in delicate spinal procedures.
- Instant identification enables surgeons to quickly locate the right bite size. Large, legible mm sizes are etched on handles, as well as color coded.

## COLOR-CODED FOR INSTANT BITE SIZE RECOGNITION

- 1 mm - Red
- 2 mm - Blue
- 3 mm - Yellow
- 4 mm - Black
- 5 mm - Green
- 6 mm - White

## HANDLING THE KMEDIC® CLEANPUNCH® RONGEUR TO OPEN:

1. Hold punch in left hand. Turn knob to "open" position (align arrows).
2. Push knob up with left thumb. Grip top slider on serrations with right hand and pull back.
3. Clean interior surfaces.

## TO CLOSE:

1. Put knob in "open" position.
2. Align guides on top slider.
3. Push top slider forward until it clicks into place.
4. Turn knob to "close" position.
5. Test for proper functioning.







雄鷹有限公司  
ASIA EAGLE CO., LTD.

Pilling®

Teleflex Medical

KMedic



Address: 台北市大安區仁愛路  
四段300巷27號1樓

Tel: 02-27089959

Toll Free: 0800-082-001

Order Email: [service@asiaeagle.com.tw](mailto:service@asiaeagle.com.tw)  
林群雄 0988-670-709

Teleflex®  
MEDICAL



# RONGEURS

Kerrison Rongeurs — CleanPunch® 2

## KERRISON CLEANPUNCH® 2 LAMINECTOMY RONGEURS



KM59306

Handle style VII, thin footplate, 7" (18 cm).

ITEM #	BITE	SIZE
KM59300	Forward	1 mm
KM59303	Forward	2 mm
KM59306	Forward	3 mm
KM59309	Forward	4 mm
KM59312	Forward	5 mm

## KERRISON CLEANPUNCH® 2 LAMINECTOMY RONGEURS



KM59313

Handle style VII, thin footplate, 8" (20.5 cm).

ITEM #	BITE	SIZE
KM59313	Forward	1 mm
KM59315	Forward	2 mm
KM59316	Forward	3 mm
KM59321	Forward	4 mm
KM59322	Forward	5 mm

## CLEANPUNCH® CLEANING SYSTEM

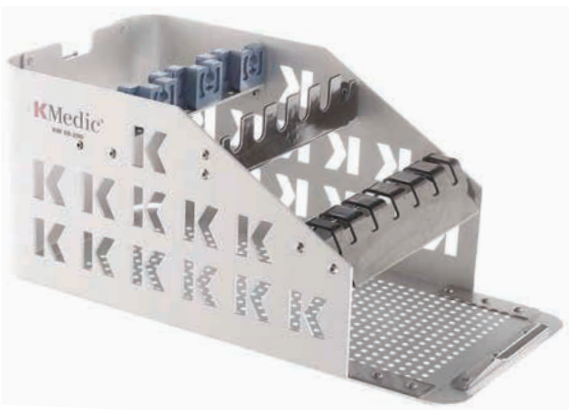

KM59200

- Holds six CleanPunches in open position for maximum exposure during cleaning and sterilization.
- Lightweight anodized aluminum construction.
- Minimize footprint – compact design has removable lid that fits under rack.
- When open, instrument handles are exposed for quick identification and easy access in the O.R.
- Silicone-coated brackets prevent metal to metal contact.
- Protects sharp cutting edge during cleaning and sterilization process.
- Fits inside a standard container or can be wrapped separately.

ITEM #	DESCRIPTION
KM59200	Approximately 13-1/2" x 7" x 6"



# RONGEURS

## Kerrison Rongeurs — Thin Footplate Design

### CERVICAL KERRISON THIN FOOTPLATE RONGEURS

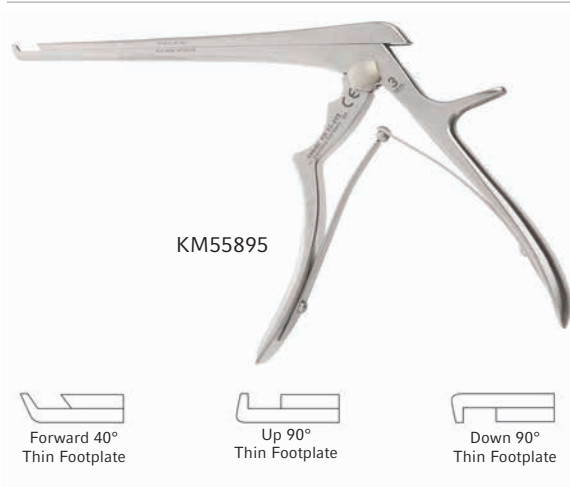

- Thin footplate designed specifically for small bone in the cervical area.
- Gold hexagonal screw denotes thin footplate.
- Bite size etched on handle for quick identification.
- Care should be taken when using delicate thin footplate punches.
- Do not twist or pry instrument while cutting.
- Do not use on large bones.

See the Instructions For Use for all instructions and contraindications.

Handle style VII, thin footplate.

ITEM #	BITE	SIZE	OVERALL LENGTH
KM55891	Forward	1 mm	6" (15 cm)
KM55892	Forward	2 mm	6" (15 cm)
KM55895	Forward	3 mm	6" (15 cm)
KM55898	Forward	4 mm	6" (15 cm)
KM55901	Forward	5 mm	6" (15 cm)
KM55904	Forward	1 mm	7" (18 cm)
KM55908	Forward	2 mm	7" (18 cm)
KM55911	Forward	3 mm	7" (18 cm)
KM55914	Forward	4 mm	7" (18 cm)
KM55917	Forward	5 mm	7" (18 cm)
KM55925	Forward	1 mm	8" (20.5 cm)
KM55926	Forward	2 mm	8" (20.5 cm)
KM55927	Forward	3 mm	8" (20.5 cm)
KM55928	Forward	4 mm	8" (20.5 cm)
KM55929	Forward	5 mm	8" (20.5 cm)
KM55905	Up	1 mm	7" (18 cm)
KM55909	Up	2 mm	7" (18 cm)
KM55912	Up	3 mm	7" (18 cm)
KM55915	Up	4 mm	7" (18 cm)
KM55918	Up	5 mm	7" (18 cm)
KM55906	Down	1 mm	7" (18 cm)
KM55910	Down	2 mm	7" (18 cm)
KM55913	Down	3 mm	7" (18 cm)
KM55916	Down	4 mm	7" (18 cm)
KM55919	Down	5 mm	7" (18 cm)



# RONGEURS

Kerrison Rongeurs — Standard Design

## LOVE-KERRISON LAMINECTOMY PUNCHES

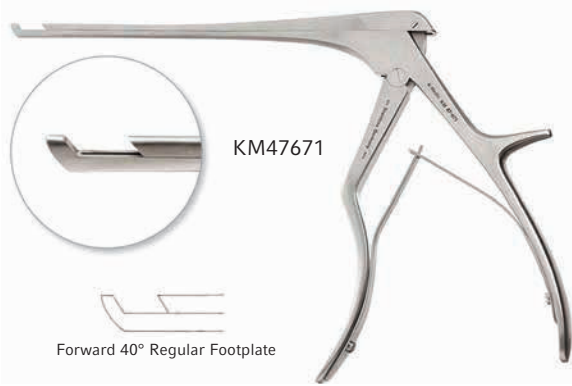

Handle style IV, large handle, regular footplate.

ITEM #	BITE	SIZE	OVERALL LENGTH
KM47676	Forward	2 mm	8" (20.5 cm)
KM47670	Forward	3 mm	6" (15 cm)
KM47671	Forward	3 mm	7" (18 cm)
KM47678	Forward	3 mm	8" (20.5 cm)
KM47680	Forward	4 mm	8" (20.5 cm)
KM47674	Forward	5 mm	6" (15 cm)
KM47682	Forward	5 mm	8" (20.5 cm)
KM47689	Forward	6 mm	11" (28 cm)





# RONGEURS

Kerrison Rongeurs — Standard Design

## LOVE-KERRISON LAMINECTOMY PUNCHES



Handle style IV, large handle, regular footplate.

ITEM #	BITE	SIZE	OVERALL LENGTH
KM47644	Up	3 mm	6" (15 cm)
KM47645	Up	4 mm	6" (15 cm)
KM47646	Up	5 mm	6" (15 cm)
KM47648	Down	3 mm	6" (15 cm)
KM47649	Down	4 mm	6" (15 cm)
KM47650	Down	5 mm	6" (15 cm)

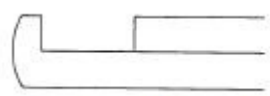

Up 90° Regular Footplate

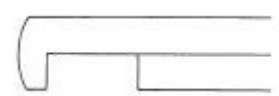

Down 90° Regular Footplate



# RONGEURS

Kerrison Rongeurs — Standard Design

## LOVE-KERRISON RONGEURS



Handle style II, large handle, regular footplate, 8" (20.5 cm).

ITEM #	BITE	SIZE
KM47620	Forward	1 mm
KM47621	Forward	2 mm
KM47622	Forward	3 mm
KM47623	Forward	4 mm
KM47624	Forward	5 mm

Forward 40° Regular Footplate

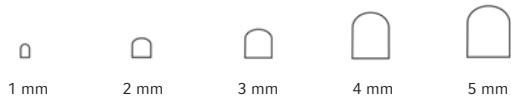



# RONGEURS

Kerrison Rongeurs — Standard Design

## LOVE-KERRISON LAMINECTOMY PUNCHES



KM47644

Handle style IV, large handle, regular footplate.

ITEM #	BITE	SIZE	OVERALL LENGTH
KM47644	Up	3 mm	6" (15 cm)
KM47645	Up	4 mm	6" (15 cm)
KM47646	Up	5 mm	6" (15 cm)
KM47648	Down	3 mm	6" (15 cm)
KM47649	Down	4 mm	6" (15 cm)
KM47650	Down	5 mm	6" (15 cm)
KM47652	Up	3 mm	8" (20.5 cm)
KM47853	Up	4 mm	8" (20.5 cm)
KM47654	Up	5 mm	8" (20.5 cm)
KM47656	Down	3 mm	8" (20.5 cm)
KM47657	Down	4 mm	8" (20.5 cm)
KM47658	Down	5 mm	8" (20.5 cm)



KM47648

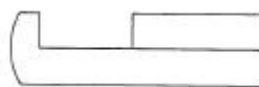

Up 90° Regular Footplate



Down 90° Regular Footplate



3 mm



4 mm



5 mm

## SPURLING-KERRISON PUNCHES



KM55871

Handle style IV, regular footplate, 8" (20.5 cm).

ITEM #	BITE	SIZE
KM55870	Forward	3 mm
KM55871	Forward	4 mm
KM55872	Forward	5 mm



Forward 40° Regular Footplate



3 mm



4 mm



5 mm



# RONGEURS

## Kerrison Rongeurs — Standard Design

### SPURLING-KERRISON PUNCHES



Compact handle design to accommodate smaller hands. Handle style V, regular footplate.

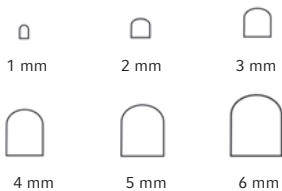
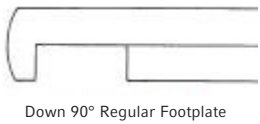
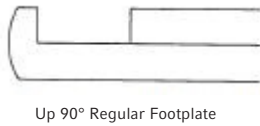
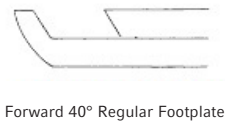

ITEM #	BITE	SIZE	OVERALL LENGTH
KM47879	Forward	1 mm	7" (18 cm)
KM47996	Forward	2 mm	7" (18 cm)
KM48024	Forward	2 mm	8" (20.5 cm)
KM47685	Forward	2 mm	11" (28 cm)
KM47997	Forward	3 mm	7" (18 cm)
KM48025	Forward	3 mm	8" (20.5 cm)
KM47686	Forward	3 mm	11" (28 cm)
KM47998	Forward	4 mm	7" (18 cm)
KM48026	Forward	4 mm	8" (20.5 cm)
KM47687	Forward	4 mm	11" (28 cm)
KM47999	Forward	5 mm	7" (18 cm)
KM48027	Forward	5 mm	8" (20.5 cm)
KM47688	Forward	5 mm	11" (28 cm)
KM47855	Forward	6 mm	7" (18 cm)
KM48028	Forward	6 mm	8" (20.5 cm)
KM48029	Forward	6 mm	11" (28 cm)
KM47988	Up	2 mm	7" (18 cm)
KM48016	Up	2 mm	8" (20.5 cm)
KM47989	Up	3 mm	7" (18 cm)
KM48017	Up	3 mm	8" (20.5 cm)
KM47990	Up	4 mm	7" (18 cm)
KM48018	Up	4 mm	8" (20.5 cm)
KM47991	Up	5 mm	7" (18 cm)
KM48019	Up	5 mm	8" (20.5 cm)
KM47857	Up	6 mm	7" (18 cm)
KM47992	Down	2 mm	7" (18 cm)
KM48020	Down	2 mm	8" (20.5 cm)
KM47993	Down	3 mm	7" (18 cm)
KM48021	Down	3 mm	8" (20.5 cm)
KM47994	Down	4 mm	7" (18 cm)
KM48022	Down	4 mm	8" (20.5 cm)
KM47995	Down	5 mm	7" (18 cm)
KM48023	Down	5 mm	8" (20.5 cm)
KM47856	Down	6 mm	7" (18 cm)





# RONGEURS

## Kerrison Rongeurs — Standard Design

### SCHLESINGER CERVICAL LAMINECTOMY RONGEURS



Handle style IV, large handle, regular footplate, 6" (15 cm).

ITEM #	BITE	SIZE
KM47610	Up	3 mm
KM47612	Up	5 mm
KM47614	Down	3 mm
KM47616	Down	5 mm

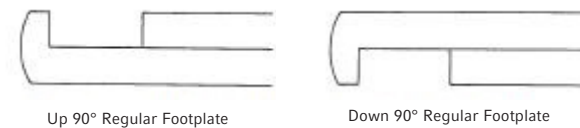

### FERRIS-SMITH KERRISON RONGEURS



Handle style IV, thin footplate, 7" (18 cm).

ITEM #	BITE	SIZE
KM48040	Up	6 mm
KM48041	Down	6 mm

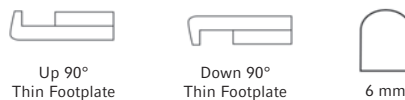

KM48041





# RONGEURS

Kerrison Rongeurs — Standard Design

## FERRIS-SMITH KERRISON RONGEURS



Handle style V, regular footplate.

ITEM #	BITE	SIZE	OVERALL LENGTH
KM48010	Forward	1 mm	6" (15 cm)
KM47987	Up	6 mm	7" (18 cm)

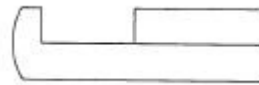

Up 90° Regular Footplate

1 mm

## FERRIS-SMITH KERRISON PUNCHES

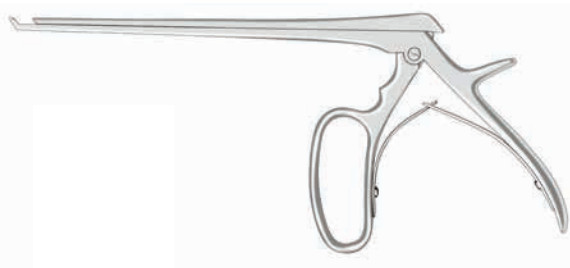

Ring handle (handle style VI), regular footplate.

ITEM #	BITE	SIZE	OVERALL LENGTH
KM55813	Forward	3 mm	7" (18 cm)
KM55823	Forward	3 mm	8" (20.5 cm)
KM55815	Forward	5 mm	7" (18 cm)
KM55825	Forward	5 mm	8" (20.5 cm)



Forward 40° Regular Footplate

3 mm

5 mm





# RONGEURS

## Kerrison Rongeurs — Standard Design

### FERRIS-SMITH ENDOSCOPIC KERRISON RONGEURS



Graduated tip, ring handle, 3-1/4" tip length, .470" shaft diameter, working length 14" (35.5 cm), overall 20" (51 cm).

ITEM #	BITE	SIZE
KM55788	Forward	2.5 mm
KM55790	Forward	4 mm
KM55782	Down	4 mm

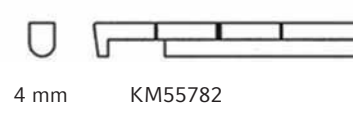
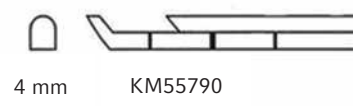
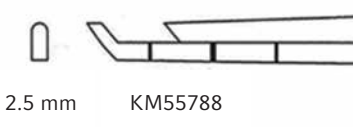

### KERRISON RONGEUR



ITEM #	BITE	SIZE	OVERALL LENGTH
411625	Up	3 mm	3-1/2" (9 cm)

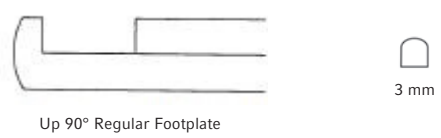

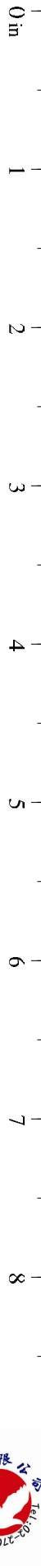

# RONGEURS

Kerrison Rongeurs — Standard Design

## KERRISON MULTI-BITE PUNCHES



Fenestrated upper shaft ejects cut pieces of bone and tissue. Delicate, thin footplate, for cervical use only, 7" (18 cm).

ITEM #	BITE	SIZE
KM55980	Up, fenestrated	2 mm
KM55981	Up, fenestrated	3 mm



## MOORELAND RONGEUR



ITEM #	DESCRIPTION
KM47850	5 x 15 mm, 13-3/4" (35 cm)

## FORAMINOTOMY PUNCHES

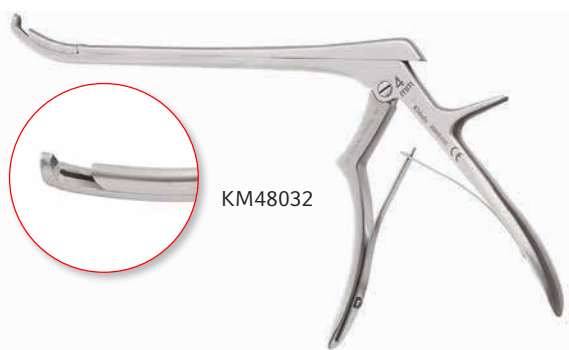

Handle style V, regular footplate, 8" (20.5 cm).

ITEM #	BITE	SIZE
KM48030	Curved up	2 mm
KM48033	Curved up	3 mm
KM48032	Curved up	4 mm

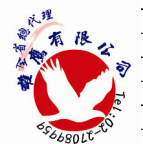
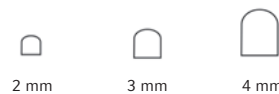



# RONGEURS

## IVD Rongeurs

### DECKER IVD RONGEUR



ITEM #	BITE	SIZE	OVERALL LENGTH
KM55858	Straight	2 x 6 mm	6" (15 cm)

### PEAPOD IVD RONGEUR



ITEM #	BITE	SIZE	OVERALL LENGTH
KM55842	Up angle	2 x 6 mm	5-1/2" (14 cm)

### SELVERSTONE IVD RONGEUR



ITEM #	BITE	SIZE	OVERALL LENGTH
KM55860	Straight	2 x 3 mm	6" (15 cm)





# RONGEURS

## IVD Rongeurs

### WILDE IVD RONGEURS



Fenestrated jaws, straight.

ITEM #	DESCRIPTION	OVERALL LENGTH
KM47707	Small, 4 x 9 mm bite	5" (12.5 cm)
KM47708	Medium, 5 x 10 mm bite	5" (12.5 cm)
KM47709	Large, 6 x 11 mm bite	5" (12.5 cm)

### CUSHING IVD RONGEURS



ITEM #	BITE	SIZE	OVERALL LENGTH
KM47710	Straight	2 x 10 mm	5" (12.5 cm)
KM47730	Straight	2 x 10 mm	7" (18 cm)
KM47712	Up angle	2 x 10 mm	5" (12.5 cm)
KM47732	Up angle	2 x 10 mm	7" (18 cm)
KM47714	Down angle	2 x 10 mm	5" (12.5 cm)
KM47734	Down angle	2 x 10 mm	7" (18 cm)

### LOVE-GRUENWALD IVD RONGEURS



ITEM #	BITE	SIZE	OVERALL LENGTH
KM47760	Straight	3 x 10 mm	5" (12.5 cm)
KM47780	Straight	3 x 10 mm	7" (18 cm)
KM47762	Up angle	3 x 10 mm	5" (12.5 cm)
KM47782	Up angle	3 x 10 mm	7" (18 cm)
KM47764	Down angle	3 x 10 mm	5" (12.5 cm)
KM47784	Down angle	3 x 10 mm	7" (18 cm)





# RONGEURS

## IVD Rongeurs

### SPURLING IVD RONGEURS



ITEM #	BITE	SIZE	OVERALL LENGTH
KM47800	Straight	4 x 10 mm	5" (12.5 cm)
KM47840	Straight	4 x 10 mm	7" (18 cm)
KM47802	Up angle	4 x 10 mm	5" (12.5 cm)
KM47842	Up angle	4 x 10 mm	7" (18 cm)
KM47804	Down angle	4 x 10 mm	5" (12.5 cm)
KM47844	Down angle	4 x 10 mm	7" (18 cm)

### CASPAR IVD RONGEURS



Fenestrated jaw, serrated cup.

ITEM #	BITE	SIZE	OVERALL LENGTH
KM55935	Straight	2 x 12 mm	6-1/4" (16 cm)
KM55936	Straight	3 x 12 mm	6-1/4" (16 cm)
KM55937	Straight	4 x 14 mm	6-1/4" (16 cm)
KM55938	Straight	5 x 14 mm	6-1/4" (16 cm)
KM55960	Straight	2 x 12 mm	7-1/4" (18.5 cm)
KM55961	Straight	3 x 12 mm	7-1/4" (18.5 cm)
KM55962	Straight	4 x 14 mm	7-1/4" (18.5 cm)
KM55963	Straight	5 x 14 mm	7-1/4" (18.5 cm)
KM55964	Straight	6 x 16 mm	7-1/4" (18.5 cm)
KM55972	Up angle	3 x 12 mm	7-1/4" (18.5 cm)
KM55973	Up angle	4 x 14 mm	7-1/4" (18.5 cm)
KM55974	Up angle	5 x 14 mm	7-1/4" (18.5 cm)
KM55966	Down angle	3 x 12 mm	7-1/4" (18.5 cm)
KM55967	Down angle	4 x 14 mm	7-1/4" (18.5 cm)



2 x 12 mm

bite straight  
KM55935  
KM55960



3 x 12 mm

bite straight  
KM55936  
KM55961



4 x 14 mm

bite straight  
KM55937  
KM55962



5 x 14 mm

bite straight  
KM55938  
KM55963



6 x 16 mm

bite straight  
KM55964

bite up angle  
KM55972

bite up angle  
KM55973

bite up angle  
KM55974

bite down angle  
KM55966

bite down angle  
KM55967



# RONGEURS

## IVD Rongeurs

### CASPAR IVD RONGEURS



6" (15 cm).

ITEM #	BITE	SIZE
KM55946	Straight	2 x 10 mm
KM55947	Straight	3 x 10 mm
KM55948	Straight	4 x 10 mm
KM55949	Straight	5 x 10 mm
KM55952	Up angle	2 x 10 mm
KM55953	Up angle	3 x 10 mm
KM55954	Up angle	4 x 10 mm
KM55940	Down angle	2 x 10 mm
KM55941	Down angle	3 x 10 mm
KM55942	Down angle	4 x 10 mm

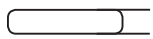

2 x 10 mm

bite straight  
KM55946

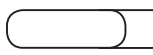

3 x 10 mm

bite straight  
KM55947

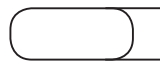

4 x 10 mm

bite straight  
KM55948



5 x 10 mm

bite straight  
KM55949

bite up angle  
KM55952

bite up angle  
KM55953

bite up angle  
KM55954

bite down angle  
KM55940

bite down angle  
KM55941

bite down angle  
KM55942

### SCHLESINGER IVD RONGEURS



Serrated jaws.

ITEM #	BITE	SIZE	OVERALL LENGTH
KM47700	Straight	2 x 10 mm	6" (15 cm)
KM47702	Straight	3 x 10 mm	6" (15 cm)
KM47704	Straight	4 x 10 mm	6" (15 cm)
KM47703	Up angle	3 x 10 mm	6" (15 cm)



2 x 10 mm

bite straight  
KM47700



3 x 10 mm

bite straight  
KM47702



4 x 10 mm

bite straight  
KM47704

bite up angle  
KM47703





# RONGEURS

## IVD Rongeurs

### SCHLESINGER IVD RONGEURS



9" (23 cm).

ITEM #	BITE	SIZE
KM55690	Straight	3 x 10 mm
KM55691	Straight	5 x 10 mm
KM55693	Up angle	3 x 10 mm
KM55694	Up angle	5 x 10 mm

### OLDBERG IVD RONGEUR



ITEM #	BITE	SIZE	OVERALL LENGTH
KM55856	Round	6 mm	7" (18 cm)





# RONGEURS

## IVD Rongeurs

### FERRIS-SMITH IVD RONGEURS



Ring handle lessens chance of slippage.  
Handle style VI, 7" (18 cm) shaft.

ITEM #	BITE	SIZE
KM47858	Straight	2 x 10 mm
KM47864	Straight	3 x 10 mm
KM47870	Straight	4 x 10 mm
KM47878	Straight	6 x 12 mm
KM47860	Up angle	2 x 10 mm
KM47866	Up angle	3 x 10 mm
KM47872	Up angle	4 x 10 mm
KM47873	Up angle	6 x 12 mm
KM47862	Down angle	2 x 10 mm
KM47868	Down angle	3 x 10 mm
KM47874	Down angle	4 x 10 mm
KM47875	Down angle	6 x 12 mm



2 x 10 mm

bite straight  
KM47858

bite up  
KM47860

bite down  
KM47862



3 x 10 mm

bite straight  
KM47864

bite up  
KM47866

bite down  
KM47868



4 x 10 mm

bite straight  
KM47870

bite up  
KM47872

bite down  
KM47874



6 x 12 mm

bite straight  
KM47878

bite up  
KM47873

bite down  
KM47875

### FERRIS-SMITH ENDOSCOPIC IVD RONGEURS

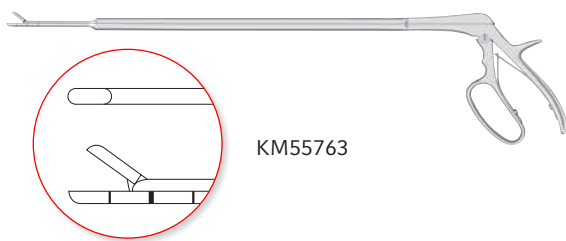

Handle style VI, ring handle, 3-1/4" tip length,  
0.470" (12 mm) shaft diameter, 10-3/4" shaft length,  
6" handle length, 20" (51 cm).

ITEM #	BITE	SIZE
KM55762	Straight	2.5 x 10 mm
KM55763	Straight	4 x 10 mm
KM55767	Up angle	4 x 10 mm
KM55777	Straight, serrated	8 x 12 mm

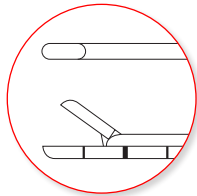

KM55763

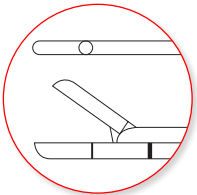

KM55762

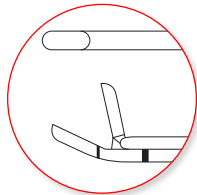

KM55767

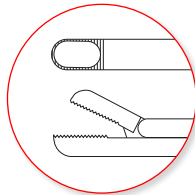

KM55777



# TL SPINAL IMPLANT REMOVAL SYSTEM

## THORACOLUMBAR SPINAL IMPLANT REMOVAL SET

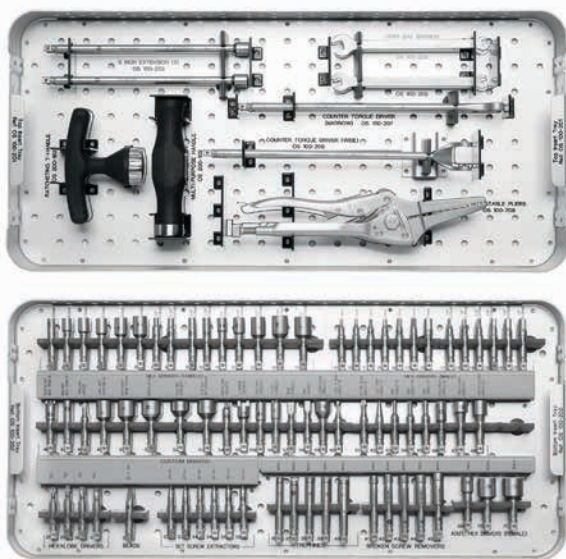

OS100200

The new **OrthoSpecialties by KMedic™ Spinal Implant Removal Set** will satisfy a surgeon's instrument needs when conducting thoracic and lumbar implant revisions.

This set offers a unique combination of implant-specific instruments in one convenient yet comprehensive set, including more than 80 standard drivers, broken screw removers, trephines, and custom bits.

ITEM #	DESCRIPTION
OS100200	Complete Thoracolumbar Set
OS100198	Instruments Only
OS100199	Case Components Only
<b>CASE COMPONENTS</b>	
OS100201	Upper Tray Insert
OS100202	Bottom Tray Insert
OS100209	Case Lid
OS100210	Case Bottom
<b>GENERAL INSTRUMENTS</b>	
OS100203	8" Extender
OS100204	Open End Wrench, 1/4" & 3/8"
OS100205	Open End Wrench, 7/32" & 9/32"
OS100206	Counter Torque Wrench, Wide
OS100207	Counter Torque Wrench, Narrow
OS100208	Adjustable Needle Nose Pliers
OS100102	Multi-purpose Handle
OS100182	Racheting T-Handle
<b>CUSTOM DRIVERS</b>	
OS100211	Advanced Spine®, Sleeve Nut
OS100212	Advanced Spine®, Anchor Screw
OS100216	Aesculap®, 4-Prong
OS100221	Corin®, 3-Lok
OS100217	Cross®, 13.8 mm Hex
OS100220	Cross®, 2-Prong
OS100218	Cross®, Cap Nut Remover
OS100224	Cross®, External Hex Scr Ext.
OS100219	Cross®, Pentalobe
OS100228	DePuy®, Cam Tightener
OS100225	DePuy®, Dodecagon
OS100293	DePuy®, Isola, Open
OS100294	DePuy®, Isola, Closed
OS100226	DePuy®, Locking & Inner
OS100292	DePuy®, Monarch Pedicle
OS100227	DePuy®, Outer Bone
OS100229	DePuy®, X15, Hexalobe
OS100290	DePuy®, X20 Hexalobe
OS100291	DePuy®, X25 Hexalobe
OS100215	SpineTech®, Octagon
OS100214	Synthes®, 11 mm (12 pt) Hex
<b>HEX DRIVERS-MALE</b>	
OS100230	2.5 mm
OS100231	3.0 mm
OS100232	3.5 mm
OS100234	4.5 mm
OS100235	5.0 mm
OS100236	7.0 mm
OS100237	7/64" (2.78 mm)
OS100238	1/8" (3.18 mm)
OS100239	5/32" (3.97 mm)
OS100240	3/16" (4.76 mm)
OS100241	7/32" (5.56 mm)
OS100242	1/4" (6.35 mm)
<b>HEX DRIVERS - FEMALE</b>	
OS100250	5.0 mm



# TL SPINAL IMPLANT REMOVAL SYSTEM

## THORACOLUMBAR SPINAL IMPLANT REMOVAL SET (CONTINUED)

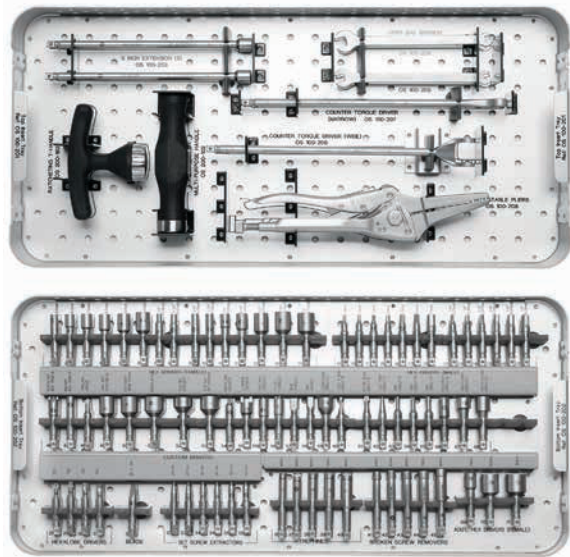

OS100200

ITEM #	DESCRIPTION
OS100251	6.0 mm
OS100252	7.0 mm
OS100295	7.5 mm
OS100253	8.0 mm
OS100254	9.0 mm
OS100255	10.0 mm
OS100296	13.0 mm
OS100297	15.0 mm
OS100256	1/8" (3.18 mm)
OS100257	5/32" (3.97 mm)
OS100258	3/16" (4.76 mm)
OS100259	7/32" (5.56 mm)
OS100260	1/4" (6.35 mm)
OS100261	5/16" (7.94 mm)
OS100262	3/8" (9.53 mm)
OS100263	7/16" (11.11 mm)
OS100264	1/2" (12.70 mm)
<b>STANDARD DRIVERS</b>	
OS100213	Phillips Driver
OS100222	Saddle, 5 mm
OS100223	Saddle, 6 mm
OS100274	Medium Blade
<b>HEXALOBE DRIVERS</b>	
OS100270	T20
OS100271	T25
OS100272	T30
OS100273	T40
<b>SET SCREW EXTRACTORS</b>	
OS100275	For 2.5 mm Hex
OS100276	For 3.0 mm Hex
OS100277	For 3.5 mm Hex
<b>TREPHINES</b>	
OS100280	For 4 mm Screw
OS100281	For 5 mm Screw
OS100282	For 6 mm Screw
OS100283	For 7 mm Screw
OS100284	For 8 mm Screw
<b>BROKEN SCREW REMOVERS</b>	
OS100285	For 4 mm Screw
OS100286	For 5 mm Screw
OS100287	For 6 mm Screw
OS100288	For 7 mm Screw
OS100289	For 8 mm Screw





# NAIL INSTRUMENTS

## Nail Nippers

### TURNBULL NAIL NIPPERS



ITEM #	DESCRIPTION
188030	4-1/2" (11.5 cm)
188032	5-5/8" (14.5 cm)

### MYCOTIC NAIL NIPPERS



Double action helps prevent hand fatigue. Ideal for Mycotic and Onychiauxis nails. Stainless, double action, barrel spring, 6" (15.5 cm).

ITEM #	DESCRIPTION
KM69445	Straight
KM69446	Concave



KM69445

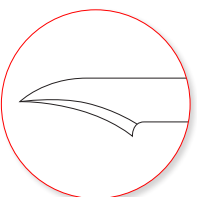
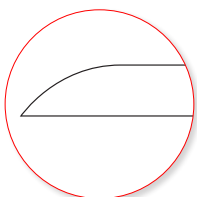

KM69445

KM69446





# NAIL INSTRUMENTS

## Nail Nippers

### NAIL NIPPERS

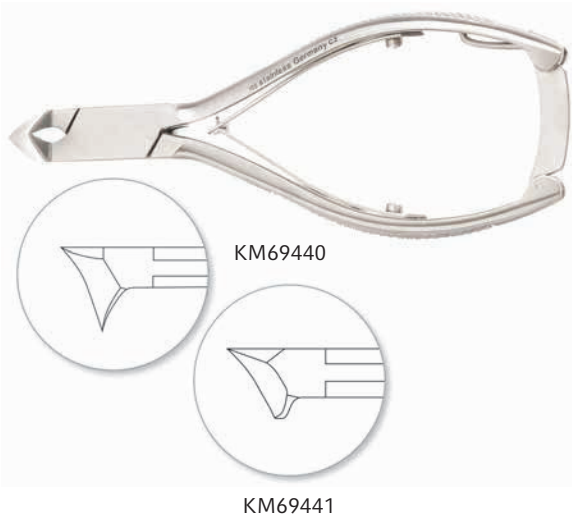

Stainless steel. Angled, concave, 5-1/2" (14 cm).

ITEM #	DESCRIPTION
KM69440	Sharp end
KM69441	Blunt end

KM69440

KM69441

### NAIL NIPPERS



Stainless steel, 5-1/2" (14 cm).

ITEM #	DESCRIPTION
KM69418	Narrow, concave
KM69430	Heavy, concave
KM69432	Heavy, straight
KM69438	Heavy, concave, super size

KM69430

KM69418

KM69430

KM69432

KM69438





# NAIL INSTRUMENTS

## Nail Nippers

### TISSUE NIPPERS



Stainless steel.

ITEM #	DESCRIPTION
KM69290	6 mm, 4" (10 cm)
KM69291	9 mm, 4" (10 cm)
KM69292	11 mm, 4-1/2" (11.5 cm)
KM69294	14 mm, 5" (12.5 cm)

## Nail Splitters

### NAIL SPLITTERS



ITEM #	DESCRIPTION
KM69557	Small, straight blade, single-ended, 6-1/8" (15.5 cm)





# NAIL INSTRUMENTS

## Nail Splitters

### NAIL SPLITTERS



With grooved handles to improve grip.

ITEM #	DESCRIPTION
KM69320	4" (10 cm)
KM69322	4-1/2" (11.5 cm)
KM69326	Heavy jaw, 5" (12.5 cm)
KM69327	Narrow jaw, 5" (12.5 cm)
KM69340	6" (15 cm)

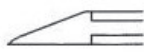

KM69320



KM69322



KM69326



KM69327



KM69340

### NAIL SPLITTERS



Our splitters have the true feel of superb craftsmanship. The cutting edge is expertly ground and specially heat treated. For a sure grip, our stainless splitters come with grooved handles. Stainless steel.

ITEM #	DESCRIPTION
KM69341	Tapered, 4" (10 cm)
KM69342	Tapered, 4-1/2" (11.5 cm)
KM69343	Tapered, 5" (12.5 cm)
KM69344	Tapered, 6" (15 cm)
KM69448	Delicate, 4-1/2" (11.5 cm)

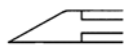

KM69341



KM69342



KM69343



KM69344



KM69348





# NAIL INSTRUMENTS

## Nail Splitters

### SHORT JAW NAIL SPLITTERS

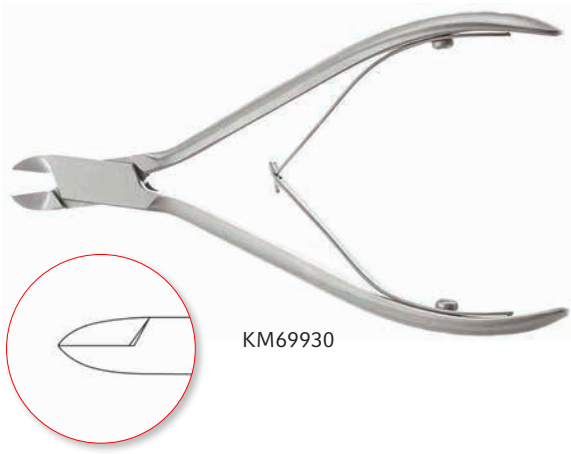

Short jaw design provides increased leverage for easier cutting of thick nails — less strain on hand and splitter. Stainless steel.

ITEM #	DESCRIPTION
KM69930	Straight, 5" (12.5 cm)
KM69932	Straight, 6" (15 cm)

## Nail Forceps

### INGROWN NAIL FORCEPS

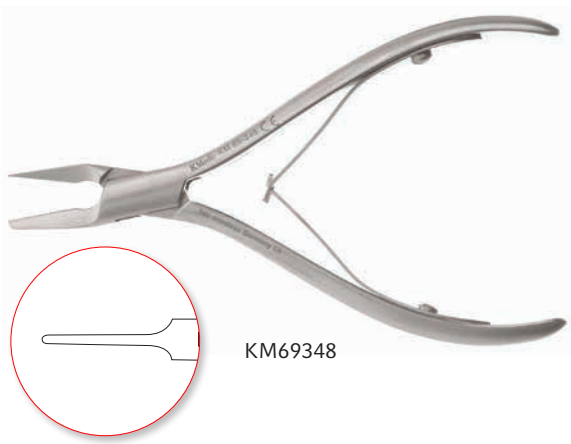

Very delicate anvil design slides easily under nails.

ITEM #	DESCRIPTION
KM69348	Anvil pattern, narrow blade, 5" (12.5 cm)







# NAIL INSTRUMENTS

## Nail Forceps

### PLATYPUS NAIL REMOVING FORCEPS



ITEM #	DESCRIPTION
KM69792	3 mm, narrow, 5-1/2" (14 cm)
KM69793	6 mm, broad, 5-1/2" (14 cm)

## Nail Scissors

### INGROWN NAIL INSTRUMENT #81



ITEM #	DESCRIPTION
KM69595	Single-ended, 5" (12.5 cm)





# NAIL INSTRUMENTS

## Nail Scissors

### INGROWN NAIL SPLITTING SCISSORS



KM69805

ITEM #	DESCRIPTION
KM69805	One serrated blade, 6" (15 cm)

### NAIL SCISSORS



KM69106

ITEM #	DESCRIPTION
KM69106	Curved, 4" (10.5 cm)





# BONE SAWS AND KNIVES

## GIGLI SAW BLADES

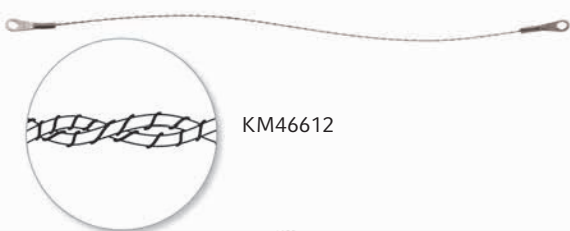

For cutting hard bone in difficult areas or situations.

ITEM #	DESCRIPTION
KM46612	9" (23 cm)
KM46613	12" (30.5 cm)
KM46609	16" (40.5 cm)
KM46614	20" (51 cm)
KM46615	30" (76 cm)
KM46616	Loop-style, 3-1/2" (9 cm) wide, one pair
KM46610	Loop-style with snap lock, 3-3/8" (8.5 cm) wide, one pair
KM46617	T-style, 2-1/2" wide, one pair



KM46616



KM46610



KM46617





# BONE SAWS AND KNIVES

## RANEY GIGLI SAW GUIDE

ITEM #	DESCRIPTION
KM46620	Curved tip, straight shaft

## CHARRIERE BONE SAWS



KM46683

Stainless steel frame, chrome blades.

ITEM #	DESCRIPTION
KM46645	10-1/2" (26.5 cm) complete
KM46646	Chrome blade only for KM46645
KM46683	14" (35.5 cm) complete
KM46684	12 mm chrome blade only for KM46683
KM46685	14 mm chrome blade only for KM46683

## JOSEPH BONE SAWS



KM58096

7" (19 cm).

ITEM #	DESCRIPTION
KM58096	Straight
KM58097	Bayonet left
KM58098	Bayonet right



KM58097

KM58098

## LANGENBECK METACARPAL SAW



KM46601

ITEM #	DESCRIPTION
KM46601	9" (23 cm)





# BONE SAWS AND KNIVES

## LISTON AMPUTATING KNIVES



KM46598

ITEM #	DESCRIPTION
KM46598	6-3/4" (17 cm) blade
KM46600	8" (20.5 cm) blade

## SATTERLEE BONE SAW



KM46643

ITEM #	DESCRIPTION
KM46643	Complete with ring handle, 11-1/2" (29 cm)

## SATTERLEE SAW BLADES ONLY



KM46642



KM46644

ITEM #	DESCRIPTION
KM46642	Blade only for KM46643, 8-3/8" (21.5 cm)
KM46644	Blade only for KM46643

## PERCY AMPUTATION SHIELD



KM46602

ITEM #	DESCRIPTION
KM46602	12" (30.5 cm)





# PLASTER CAST INSTRUMENTS

## BRUNS SHEARS



For heavier plaster.

ITEM #	DESCRIPTION
KM46090	One blade serrated, 9-3/8" (24 cm)

## STILLE PLASTER SHEARS



For cast removal.

ITEM #	DESCRIPTION
KM46156	15" (38 cm)

## PEDIATRIC CAST BREAKER

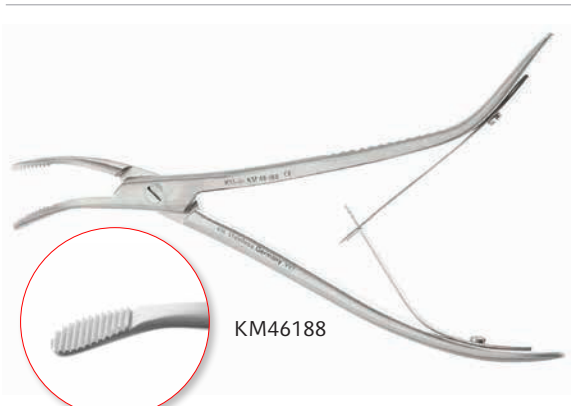

ITEM #	DESCRIPTION
KM46188	7" (18 cm)





# PLASTER CAST INSTRUMENTS

## WOLFF (BOEHLER) CAST BREAKERS

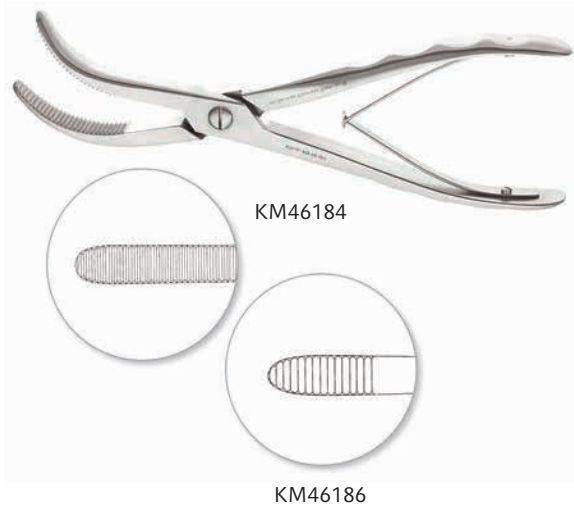

ITEM #	DESCRIPTION
KM46186	Small, 7" (18 cm)
KM46184	9-7/8" (25 cm)

## HENNIG PLASTER SPREADER



To relieve cast pressure or for cast removal.  
One-handed operation.

ITEM #	DESCRIPTION
KM46138	10-5/8" (27 cm)





# PLASTER CAST INSTRUMENTS

## KMEDIC® CAST SPREADER



KM46134

To relieve cast pressure or for cast removal.  
One-handed operation.

ITEM #	DESCRIPTION
KM46134	8-7/8" (22.5 cm)

## WALTON CAST SPREADER



KM46133

To relieve cast pressure or for cast removal.  
One-handed operation.

ITEM #	DESCRIPTION
KM46133	8-5/8" (22 cm)

## REINER PLASTER KNIFE



KM46058

Stainless handle.

ITEM #	DESCRIPTION
KM46058	7" (18 cm)





# PLASTER CAST INSTRUMENTS

## ENGEL PLASTER SAW



KM46056

Chrome handle and stainless blade.

ITEM #	DESCRIPTION
KM46056	6" (15 cm)

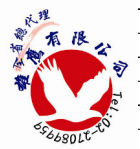



# MEASURING DEVICES

## Rulers

### FLEXIBLE RULERS



KM39694

Inch and millimeter graduated.

ITEM #	DESCRIPTION
KM39692	6" (152 mm)
KM39694	8" (203 mm)
KM39698	12" (305 mm)
KM39700	20" (508 mm)

### KUNTSCHER X-RAY SCALE



KM48299

Ruler for X-rays.

ITEM #	DESCRIPTION
KM48299	Graduated in mm, 19-5/8" (50 cm)

### MEASURING TAPE



KM48313

ITEM #	DESCRIPTION
KM48313	Linen, graduated in inch and cm up to 150 cm



# MEASURING DEVICES

## Calipers

### CASTOVIEJO CALIPER



ITEM #	DESCRIPTION
KM53042	Graduated in mm up to 40 mm, 6-1/2" (16.5 cm)

### TOWNLEY FEMUR CALIPER



Takes inside and outside measurements up to 4" (10 cm).

ITEM #	DESCRIPTION
KM48314	4-1/2" (11.5 cm)

### NEURO CALIPER



Inside measuring faces extra long (60 mm) for neurosurgery. Inside and outside measuring faces and depth bar, stainless steel.

ITEM #	DESCRIPTION
KM48315	Graduated in inch/mm to 5-3/4" (145 mm), 9" (23 cm)





# MEASURING DEVICES

## Specialty

### BONE COMPASS

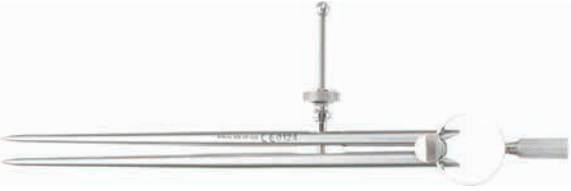

KM48302

ITEM #	DESCRIPTION
KM48302	8" (20.5 cm)

### POLK FINGER GONIOMETER



KM48310

ITEM #	DESCRIPTION
KM48310	Graduated in inch and cm, 6" (15 cm)



# SMARTRACKS

## CLEANPUNCH® CLEANING SYSTEM



KM59200

- Holds six CleanPunches® in open position for maximum exposure during cleaning and sterilization.
- Lightweight anodized aluminum construction.
- Minimize footprint - compact design has removable lid that fits under rack.
- When open, instrument handles are exposed for quick identification and easy access in the OR.
- Silicone-coated brackets prevent metal to metal contact.
- Protects sharp cutting edge during cleaning and sterilization process.
- Fits inside a standard container or can be wrapped separately.

ITEM #	DESCRIPTION
KM59200	Approximately 13-1/2" x 7" x 6"



# SMARTRACKS FOR OSTEOTOMES



## HOKE SMARTRACK

KM98150

8-1/4" x 5" x 2-1/4"

(21 cm x 12.5 cm x 5.5 cm)

Holds eight 5-1/4" (13.5 cm)

## LIGHTWEIGHT RACKS FOR STERILIZATION AND STORAGE

- Nylon coated brackets help avoid metal-to-metal contact.
- Plastic plate on underside of top bracket helps protect sharp tips from being damaged.
- Side arm stays locked to help prevent instruments from falling out, even when turned upside down.
- Deep brackets hold instruments in place.
- Custom designed base keeps instruments upright during loading and unloading.
- Reinforced, sturdier frames are made from corrosion-resistant anodized aluminum.
- Fully autoclavable to 270°F/132°C.
- Quick reference chart easily identifies the type and size instrument rack holds.
- Manufactured only by Teleflex®.



# SMARTRACKS

## BRUN SMARTRACK FOR 7" CURETTES

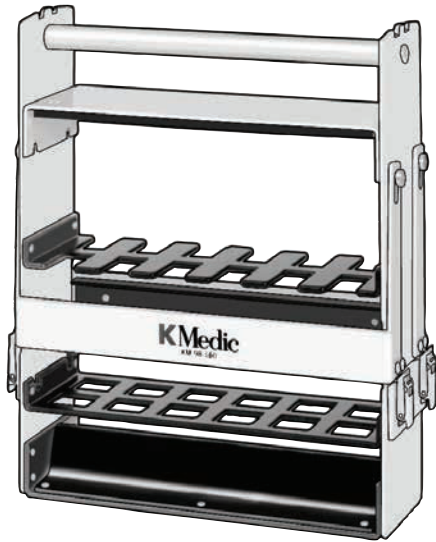

KM98160

Aluminum and stainless steel, nylon coated brackets.

ITEM #	DESCRIPTION
KM98160	Holds twelve 7" KMedic® Brun Currettes

## COBB SMARTRACK FOR 11" INSTRUMENTS



KM98170

Aluminum and stainless steel, nylon coated brackets.

ITEM #	DESCRIPTION
KM98170	Holds nine 11" KMedic® Cobb Currettes, Elevators or Gouges





# SMARTRACKS

## HIBBS AND BRUN SMARTRACK FOR 9" INSTRUMENTS



KM98180

Aluminum and stainless steel, nylon coated brackets.

ITEM #	DESCRIPTION
KM98180	Holds twelve 9" KMedic® Brun Currettes, or Hibbs Chisels, Gouges or Osteotomes

## SMARTRACK LAMBOTTE FOR 9" OSTEOTOMES



KM98190

ITEM #	DESCRIPTION
KM98190	Holds twelve 9" (23 cm) KMedic® Lambotte Osteotomes, 11-3/4" x 5-1/2" x 3-3/8" (30 x 8.5 x 14 cm), nylon coated brackets





# SMARTRACKS

## SMITH PETERSON SMARTRACK



KM98195

Holds fourteen 8" KMedic® Smith Peterson osteotomes or gouges, nylon coated brackets.

ITEM #	DESCRIPTION
KM98195	Approximately 11" x 10" x 4" (28 x 25.5 x 10 cm)

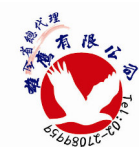



# SPECIALTY TRAYS

## Flat Packs

### INSTRUMENT FLAT PACKS



Covers made of leather. Removeable inserts made of cotton.

ITEM #	DESCRIPTION
KM98112	Holds twelve instruments, 7" x 4" (18 x 10 cm)
KM98116	Holds sixteen instruments, 8" x 5" (20 x 12.5 cm)
KM98120	Holds twenty instruments, 8" x 6" (20 x 15 cm)
KM98112P	One cotton insert for KM98112. Holds twelve instruments.
KM98116P	Pair of cotton inserts for KM98116. Holds sixteen instruments.
KM98120P	Pair of cotton inserts for KM98120. Holds twenty instruments.



# MISCELLANEOUS ORTHOPEDIC

## Lead Hands

### LEAD HANDS



KM49090

Oxidation of lead surfaces is a normal process. To prolong the life of lead hands, autoclave temperatures should not exceed 248 degrees F (120 degrees C). Avoid using chemical sterilization as it can cause severe corrosion.

ITEM #	DESCRIPTION
KM49090	Adult, 14-1/2" (37 cm)
KM49092	Child, 9-1/2" (24 cm)

### LEAD HANDS

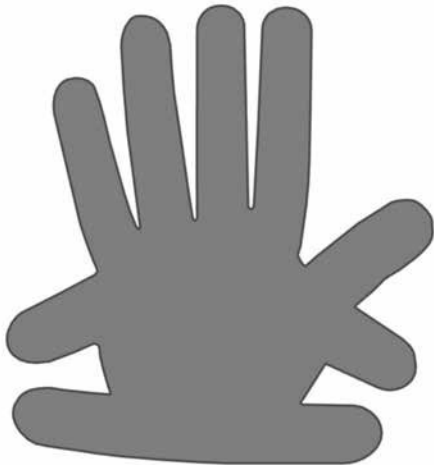

KM49093

Thinner and more flexible model. Longer fingers wrap on ends eliminating side tabs.

ITEM #	DESCRIPTION
KM49093	Adult, 2 mm thick, 9-1/2" (24 cm)





# MISCELLANEOUS ORTHOPEDIC

## Ring Cutters

### FINGER RING CUTTER



ITEM #	DESCRIPTION
KM29430	Chrome, with saw blade, 6-1/4" (16 cm)
KM29434	Saw blade only

## Diagnostic Instruments

### BUCK NEURO HAMMER STAINLESS



Stainless steel with brush and needle.

ITEM #	DESCRIPTION
KM28492	7-3/4" (19.5 cm)



# MISCELLANEOUS ORTHOPEDIC

## Diagnostic Instruments

### TAYLOR PERCUSSION HAMMER



KM28468

ITEM #	DESCRIPTION
KM28468	8" (20.5 cm)

### WARTENBERG NEUROLOGICAL PIN WHEEL



KM28514

ITEM #	DESCRIPTION
KM28514	7" (18 cm)

## Specialty Hand Instruments

### JOHNSON-TUCKER HOOK AND FORK



KM69790

ITEM #	DESCRIPTION
KM69790	Double ended, delicate, 6-1/2" (16.5 cm)

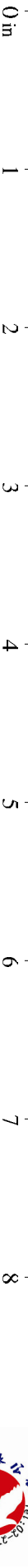



# MISCELLANEOUS ORTHOPEDIC

## Specialty Hand Instruments

### EXCAVATOR AND PACKER



KM69502

ITEM #	DESCRIPTION
KM69502	Double-ended

### PROBE AND PACKER



KM69495

ITEM #	DESCRIPTION
KM69495	Double-ended, 1 mm and 2 mm ends, 6" (15 cm)

### SPATULA AND PACKER



KM69498

ITEM #	DESCRIPTION
KM69498	Double-ended, 5-3/4" (14.5 cm)

### VERUCCA CURETTE EXCAVATOR



KM69457

With McGlamry Bullneck. Will resist bending.



ITEM #	DESCRIPTION
KM69457	Single-ended, straight, 4 mm without hole, 5" (12.5 cm)

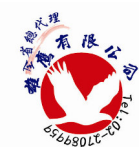



# MISCELLANEOUS ORTHOPEDIC

## Specialty Hand Instruments

### EXCAVATOR AND PROBE



KM69518

ITEM #	DESCRIPTION
KM69518	Double-ended, 1 mm and 1.5 mm ends, 6" (15 cm)

### CURETTE EXCAVATORS



KM69488

ITEM #	DESCRIPTION
KM69488	Double-ended, 1.5 mm and 2.0 mm ends, 5-1/2" (14 cm)
KM69492	Double-ended, 1.5 mm and 2.5 mm ends, 5-1/2" (14 cm)

### CURETTE EXCAVATORS



KM69480

Single-ended, with hole, 5" (12.5 cm).

ITEM #	DESCRIPTION
KM69468	#58, 1.0 mm
KM69478	#58, 1.5 mm
KM69480	#58, 2.0 mm
KM69484	#58, 2.5 mm

### CURETTE EXCAVATORS



KM69463

Single-ended, without hole, 5" (12.5 cm).

ITEM #	DESCRIPTION
KM69459	#57, 1.0 mm
KM69461	#57, 1.5 mm
KM69463	#57, 2.0 mm
KM69465	#57, 2.5 mm





# MISCELLANEOUS ORTHOPEDIC

## Specialty Hand Instruments

### LOCKE ELEVATORS



KM69579

With McGlamry Bullneck. Will resist bending.

ITEM #	DESCRIPTION
KM69579	Narrow blade, single-ended, 4-1/2" (11.5 cm)
KM69590	Wide blade, single-ended, 5" (12.5 cm)

### CORN KNIVES



KM69623



KM69625

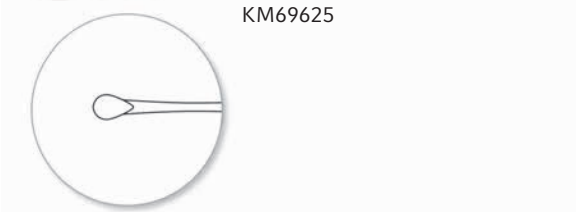

KM69622

Single-ended.

ITEM #	DESCRIPTION
KM69622	Soft Corn Knife, #45, straight, round blade
KM69623	Soft Corn Spoon Knife, slightly curved, oval blade
KM69625	Corn Knife, curved

### GOLF STICK KNIVES



KM69620

ITEM #	DESCRIPTION
KM69618	#41
KM69620	#43







# MISCELLANEOUS ORTHOPEDIC

## Specialty Hand Instruments

### CHISELS

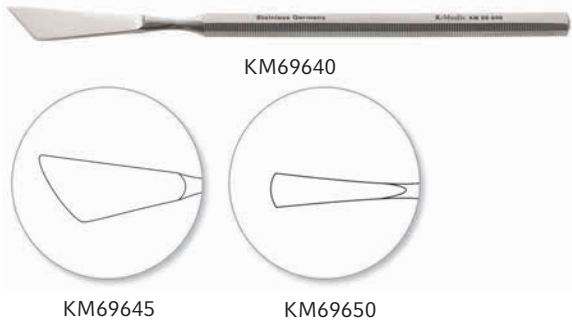

ITEM #	DESCRIPTION
KM69640	Curved, medium
KM69645	Curved, extra-large
KM69650	Curved, spade pattern

### WRIST TENDON APPROXIMATOR

ITEM #
KM52450





# MISCELLANEOUS ORTHOPEDIC

## PELVIC BALL SPIKE



ITEM #	DESCRIPTION
KM47906	Straight, 11-3/4" (30 cm)
KM47921	Spiked disk only

## BONE MILL

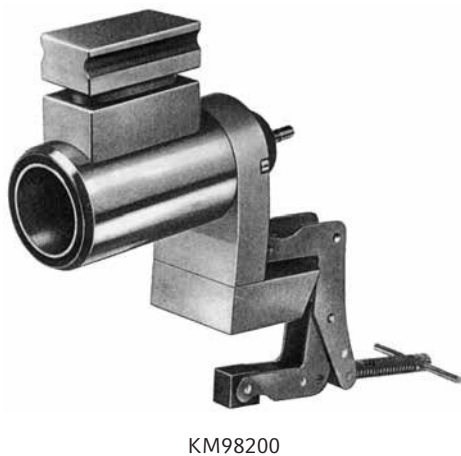

ITEM #	DESCRIPTION
KM98200	With crank and table clamp

## FIXATION PIN

ITEM #
KM47907



# MISCELLANEOUS ORTHOPEDIC



## KUNTSCHER EXTRACTORS

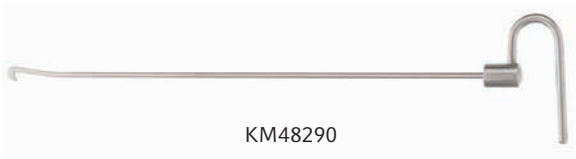

ITEM #	DESCRIPTION
KM48288	Femoral, 19-1/8" (48.5 cm)
KM48290	Tibial, 19-1/4" (49 cm)

## KUNTSCHER REAMER

ITEM #	DESCRIPTION
KM48301	Cannulated, 15" (38 cm)

## KUNTSCHER SKIN PROTECTOR

ITEM #	DESCRIPTION
KM48297	6-1/8" (15.5 cm)





雄鷹有限公司  
ASIA EAGLE CO., LTD.

Pilling®

Teleflex Medical

KMedic



Address: 台北市大安區仁愛路  
四段300巷27號1樓

Tel: 02-27089959

Toll Free: 0800-082-001

Order Email: [service@asiaeagle.com.tw](mailto:service@asiaeagle.com.tw)  
林群雄 0988-670-709

Teleflex®  
MEDICAL

# INDEX

## Alphabetical

### #

1 mm Fine Perforated Cases.....	322
10 mm Dissectors.....	1138
5 mm Bipolar Forceps.....	1141
5 mm Dissectors, Grasping Forceps.....	1135
5 mm Needle Holders.....	1147
5 mm Ratcheted Graspers.....	1142
5 mm Scissors.....	1148
5-10 mm Biopsy Forceps.....	1139

### A

Abdominal Vascular Retractor Set With Split Wishbone - Components.....	241
Ablaza-Blanco Cardiac Valve Retractor.....	755
Abraham Laryngeal Syringe Cannula.....	435
Abramson-Dedo Micro-Laryngoscope.....	397
Abrams Pleural Biopsy Needle.....	767
Access Ports.....	1167
Accessory Boxes.....	334
ACMI Illuminator End Adapter For Type II Cables.....	464
Adair-Allis Intestinal Tissue Forceps.....	87
Adair Tenaculum.....	278
Adams Tissue Forceps.....	53
Adapter, Electrosurgical.....	1161
Adapter (Power Drill).....	856
Adapters, Fiber Optic.....	464
Adenotome Blades.....	521
Adenotomes/Tonsectomes.....	521
Adson-Brown Laser Tissue Forceps.....	45
Adson-Brown Titanium Tissue Forceps.....	686
Adson-Debaque® Tissue Forceps.....	44
Adson Dissector Hooks.....	882
Adson Dressing Forceps.....	34
Adson Hemostatic Forceps.....	56
Adson Laser Tissue Forceps.....	36
Adson Periosteal Elevators.....	960
Adson Rat Tooth Rongeur.....	1031
Adson Retractor.....	220, 907
Adson Rongeurs.....	1031
Adson Suction Tubes.....	243
Adson Suction Tubes, Curved.....	243
Adson Tissue Forceps.....	43
Adson Titanium Dressing Forceps.....	686
Adson Titanium Tissue Forceps.....	686
Air Injection Cannula.....	1128
Air-Lon® Trachea Tube Inhalation Sets.....	484
Air-Lon® Trachea Tubes.....	484
Alexander Chisels.....	1002
Alexander Gouges.....	1005
Alexander Periosteal Rasp.....	978
Alexander Periosteotome.....	716
Allen Intestinal Clamps.....	87
Allerdyce Elevator and Dissector.....	504, 957
Alligator Applying Forceps and Ligating Clips.....	779
Alligator Forceps.....	494
Alligator Nasal Forceps.....	505
Allis Delicate Tissue Forceps.....	88
Allis Grasper.....	1144
Allison Lung Retractors.....	215, 744
Allis Tissue Forceps.....	88, 251
Alm Retractors.....	217
Aluminum Utility Cases.....	322
Amato Neonatal Sternal Retractors.....	728
Amato Pediatric Dilators Set.....	768
Anderson Adson Retractor.....	221
Anderson-Nievert Osteotomes.....	508
Andrews Infant Suction Tube.....	246, 765
Andrews Pynchon Suction Tube.....	246, 765
Andrews Tongue Depressor.....	528
Angled Bone Holding Forceps.....	929
Angled Laser Retractors.....	430
Angled Pelvic Bone Reduction Forceps.....	936
Angle Finder.....	310
<b>Aortic Punches</b> .....	762
Diamond Edge Design.....	762
Reusable Punches.....	763
Aortic Vascular Clamps.....	628
Approximation Clamp.....	319
Approximators.....	714
Army Pattern Chisels.....	1002
Asch Septum Forceps.....	507
Aspirating Needle.....	775
Aspirating Tubes.....	431
Asymetric Pelvic Reduction Forceps.....	936
Atraumatic Allis Grasper.....	1145
Aufranc Cobra Retractors.....	889
Aufricht-Glabella Rasp.....	510, 974
Aufricht Nasal Retractor.....	520
Aufricht Rasp.....	509, 974
Auto Endo5® Applier.....	375
Auvard Weighted Vaginal Specula.....	285
Awls.....	942
<b>B</b>	
Babcock Grasper.....	1145
Babcock Tissue Forceps.....	90, 251, 555
Baby Metzenbaum Scissors.....	122
Backbiter Forceps.....	514
Backhaus Towel Clamps.....	30
Backhaus Towel Forceps Ebonized.....	30
Bacon Rongeur.....	1028
Bahnson Aorta Clamp.....	629
Bailey Aorta Clamps.....	629
Bailey Aortic Valve Rongeurs.....	757
Bailey Cardiac Technique® Needle Holder.....	169, 674
Bailey-Gibbon Rib Approximator Retractor.....	716
Bailey Rib Approximator Retractors.....	716
Bainbridge Forceps.....	91
Bakes Common Duct Dilators Set.....	309
Bakst Cardiac Scissors.....	667
Balfour Center Blades.....	233
Balfour Fourth Blade Attachments.....	234



Balfour Retractors .....	230	Biopsy Punch, OB/GYN .....	266
Balfour Retractors Permanent Side Blade Model .....	231	Biopsy Punch Forceps .....	1139
Ballenger Knives .....	508	Biro Dermal Naevus Scissors .....	133
Ballenger Sponge Forceps .....	25	Bishop Bone Clamp .....	939
Balloon Catheter .....	1166	Bishop Harmon Anterior Chamber Irrigation Cannula .....	1129
Bane Rongeur .....	1026	Bishop-Harmon Dressing Forceps .....	1102
Bantam Wire Cutting Scissors .....	110	Bishop-Harmon Tissue Forceps .....	1104
<b>Bariatric, Open/Extended Length</b> .....	249	Blade Retractors .....	886
Forceps and Clamps .....	249	Blair (Rollet) Retractor .....	193
Knife Handles/Suction Tubes .....	249	Blake Gallstone Grasping Forceps .....	93
Needle Holders .....	259	Blakesley Nasal Forceps .....	505
Retractors .....	261	Blanco Valve Instruments .....	755
Scissors .....	256	Bland Cervical Traction Forceps .....	264
Barnhill Adenoid Curettes .....	522	Blepharoplasty Scissors .....	133
Baron Suction Tubes .....	245	Blount Double Prong Retractor .....	893
Barraquer Cilia And Suture Forceps .....	1109	Blount Knee Retractor .....	893
Barraquer Delicate Needle Holders .....	181	Blount Single Prong Retractor .....	893
Barraquer Micro Needle Holders .....	175, 180	Blue Fiber Optic Cables .....	463
Barraquer Needle Holders .....	1121	Blunt Nose Grasper .....	1136
Barraquer Wire Speculums .....	216, 1125	Bodenhammer Rectal Speculum .....	302
Barraya Titanium Tissue Forceps .....	687	Boettcher Tonsil Scissors .....	530
Barr Crypt Hook .....	305	Boies Nasal Elevator .....	503
Barrett Tenaculum .....	278	Bonchek-Carpentier Sternal/Atrial Valve Retractor .....	737
Barron Hemorrhoidal Alligator Seizing Forceps .....	298	Bone Awl .....	943
Baumgarten Wire Twister .....	182, 684	Bone Chip Packers .....	1009
Baumgartner Bulldog® Needle Holder .....	150	Bone Compass .....	311, 1084
Baumgartner Needle Holder .....	150	Bone Cutting Forceps .....	1019
Bayonet Nerve Retractor .....	884	Bone File .....	973
Beall Circumflex Artery Scissors .....	656	Bone File #10 .....	970
Beall Micro Coronary Scissors .....	657	Bone File #12 .....	970
Beasley-Babcock Tissue Forceps .....	46	Bone File #12A .....	970
Becker Septum Scissors .....	512	Bone File #12Ca .....	971
Beckman-Adson Laminectomy Retractors .....	222, 908	Bone File #33 .....	971
Beckman-Adson Retractors .....	223, xx	Bone File #45 .....	971
Beckman-Eaton Retractor .....	908	Bone File #92A .....	972
Beckman Retractor .....	222, 907	Bone File #92B .....	972
Beckman-Weitlaner Retractors .....	221, 908	<b>Bone Files and Rasps</b> .....	970
Beck Miniature Pediatric Aortic Clamp .....	589	Bone Files .....	970
Beck-Type Aorta Clamps .....	630	Bone Rasps .....	973
Beck-Type Vessel Clamp .....	590, 596	<b>Bone Holding Instruments</b> .....	918
Bellina Laser Rulers .....	288	Bone Clamps .....	939
Bellucci Alligator Scissors .....	498	Bone Holding Forceps .....	918
Bending Irons .....	880	Bone Reduction Forceps .....	931
Bending Irons and Rod Holders .....	877	<b>Bone Hooks and Awls</b> .....	942
Bending Pliers .....	845	Awls .....	943
Bending Templates .....	880	Bone Hooks .....	942
Bengolea Forceps .....	57	Bone Impactor .....	1009
Bennett Bone Elevator and Retractors .....	889	Bone Mill .....	1098
Bergh Cilia Forceps .....	1109	Bone Rasp .....	974
Bergman Mallets .....	1015	Bone Rasp #64 .....	972
Bernay Finger Rake Tracheal Retractors .....	192, 491	Bone Reduction Forceps .....	932
Berry Angio Access Tunneler .....	796	Bone Saws and Knives .....	1075
Berry Sternal "Big Ugly" Technique® Needle Holder .....	183, 684	<b>Bone Tamps and Impactors</b> .....	1009
Best Colon Clamp .....	92	Bone Tamps .....	1009
Bethea Sheet Holders .....	291	Impactors .....	1010
Bethune Rib Cutter .....	718	Bonney Tissue Forceps .....	46
Beyer Bone Biting Rongeur .....	1029	Bonnier Catheter Adapter .....	435, 766
Beyer Rongeurs .....	1034	Bonn Iris Tissue Forceps .....	1104
Billeau Ear Loops .....	493	Boston University Suspension System .....	411
Biopsy Cup Forceps .....	451	Boston University System Laryngoscope	
Biopsy Forceps .....	1139	Handle Extension .....	412
Biopsy Grasper .....	1139	Boston University System Pivoting Extension	
Biopsy Punch .....	1140	Arm Assembly .....	412





Boucheon Ear Speculum.....	499
<b>Bougies/Dilators</b> .....	465
Esophageal Bougies.....	465
Laryngeal Dilators.....	468
Bougie Sterilization Tray.....	466
Bovie Cord For Suction Tube.....	462, 775
Bovie Pencil Handle.....	776
Bowel Grasper-Hunter.....	1137
Bowls.....	329
Bowman Lacrimal Probes.....	307, 1126
Boxes With Entries = Endoscope Sizes Available.....	444
Bozeman Uterine Dressing Forceps.....	262
Brachial Large Vessel Approximators.....	318
Brachial Large Vessel Clips.....	318, 567
Brand Tendon Pulling Forceps.....	950
Braun Episiotomy Scissors.....	272
Braun Tenaculum.....	278
Brewster Phrenic Retractors.....	202
Brewster Retractors.....	196
Bridge Hemostatic Forceps.....	57
Bridge X-Action Forceps.....	251
Brigham Dressing Forceps.....	41
Brinkerhoff Rectal Specula.....	302
Bristow/Bankart Humeral Retractor.....	892
Bristow/Bankart Soft Tissue Retractor.....	891
Bronchial and Esophageal Instrumentation.....	451
<b>Bronchoscopes</b> .....	445
Bronchoscope Accessories.....	441
Cleaning Brushes.....	445
Holinger Design.....	438
Holinger Pediatric Design.....	439
Laser Bronchoscopes.....	440
Bronchoscope Adapter.....	441
Bronchoscope System.....	440
Bronchoscope Window Plug Replacement Lens.....	441
Bronchus Clamp.....	555
Brown-Adson Tissue Forceps.....	44
Brown Needle Holder.....	151
Brown Tissue Forceps.....	46
Bruening Bayonet Nasal Snare.....	517
Brun Currettes.....	981
Brun Smartrack For 7" Currettes.....	991, 1087
Brun (Spratt) Currettes.....	979
Bruns Shears.....	1078
<b>Brushes</b> .....	444
Bronchoscope.....	444
Tracheostomy Tubes.....	492
Buck Ear Currettes.....	493
Buck Neuro Hammer Stainless.....	1092
Buie Pile Clamp.....	298
Buie Suction Tubes.....	306
<b>Bulldog® and Micro Vessel Clamps</b> .....	560
Bulldog® Clamps.....	560
Micro Vessel Clamps.....	568
Bulldog® Clamp Applying Forceps.....	567
Bullet Nose Dissector.....	1136
Bunnell Drill.....	850
Bunnell Tendon Strippers.....	952
Bunt Forceps Holder.....	341
Burford Adult Retractor.....	737
Burford Aluminum Adult Retractor.....	737
Burford-Finochietto Infant-Child Retractor.....	729
Busch Umbilical Scissors.....	271

## C

Cables, Pilling® Blue Fiber Optic.....	463
Calipers.....	1082, 1130
Callison-Adson Tissue Forceps.....	44
Calman Carotid Bulldog® Clamps.....	604
Calman Clamp.....	607
Camera and Light Cord Cases.....	330
Cannula Cleaners.....	343
Cannulas.....	764, 1151
Cannulas, Irrigation.....	1128
Cannulated Pin Cutter.....	827
Caplan Nasal Scissors.....	512
Capsule Retractor.....	891
Cardiac Valve Forceps.....	549
Cardiac Valve Hook, Calibrated.....	758
<b>Care and Cleaning</b> .....	10
Carlens Mediastinoscopes.....	774
Carmalt Forceps.....	58, 251
Carmalt Splinter Forceps.....	32
Carroll Tendon Retriever.....	949
<b>Cartilage and Tendon Instruments</b> .....	946
Cartilage Knives.....	950
Cartilage Scissors.....	951
Clamps and Forceps.....	946
Tendon Strippers.....	952
Caspar IVD Rongeurs.....	1062
Castaneda Pediatric Clamps.....	575
Castaneda Titanium Vascular Clamping Forceps.....	693
Castroviejo Caliper.....	311, 1083, 1130
Castroviejo-Colibri Tissue Forceps.....	1104
Castroviejo Corneo-Scleral Forceps.....	1111
Castroviejo Keratoplasty Micro Scissors.....	1112
Castroviejo Keratoplasty Scissors.....	1112
Castroviejo Lacrimal Dilator.....	1127
Castroviejo Micro Needle Holders.....	176, 681
Castroviejo Needle Holders.....	176, 681, 1121
Castroviejo Scissors.....	673, 1112
Castroviejo Suture Forceps.....	1106
Castroviejo Technique® Needle Holders.....	178, 680
<b>Catheters</b> .....	297
Catheter Guides.....	297
Cholangiography.....	1165
Coronary Perfusion Catheters.....	761
Centimeter Subtraction Ruler.....	309, 435
Cervical Kerrison Thin Footplate Rongeurs.....	1050
Cervical Laser Hooks.....	288
Cervical Retractor Set.....	906
Chandler Elevators.....	969
Chariere Bone Saws.....	1076
Chaux Deep Blade Assembly.....	722
Chaux-Lemole Bi-Angle T-Frame.....	754
Chaux Multipurpose Sternal Ima Retractor.....	720
Chaux Sternal Ima-Mitral Valve Retractor.....	721
Cheanvechai-Favaloro Swivel Rake Assembly.....	725
Cheanvechai Rake Assembly.....	725
Cherry Supraceliac Clamp.....	630
Chest Drain Pulling Clamp.....	559
Chichirelli (Blumenthal) Rongeur.....	1027
Children's Hospital Retractor.....	202
<b>Chisels and Gouges</b> .....	1002
Chisels.....	1002
Gouges.....	1005



<b>Chisel and Gouge Set</b> .....	1000	Collier Hemostatic Forceps.....	60
Interchangeable Osteotome, Chisel and Gouge Set.....	1000	Collin Lung Tissue Forceps.....	555
Church Scissors.....	118	Collin Mallet.....	1013
Circumtract Set - Components.....	239	Collins Tongue Seizing Forceps.....	523
<b>Clamps</b> .....	26	Colver Coakley Tonsil Forceps.....	523
Aortic Aneurysm Clamps.....	648	Combination Mallet Caps.....	1015
Aortic Compressor.....	655	Combination Mallets.....	1015
Aortic Vascular Clamps.....	629	Combination Wrench.....	847
Bariatric.....	249	Cone Ring Curettes.....	987
Bone Clamps.....	939	Conn Aortic Compressor.....	655
Bronchus and Lung Clamps.....	555	<b>Container Systems</b> .....	368
Bulldog® Clamps.....	560, 703	Accessories.....	370
Carotid Clamps.....	604	Pilling® Container Systems.....	368
Carotid Clamps, 1 mm Jaw.....	607	Containers and Trays.....	326
Carotid Clamps, 1.5 mm Jaw.....	609	Converse Needle Holder.....	151
Cartilage and Tendon Instruments.....	946	Converse Rasp.....	510, 975
Chest Drain Pulling Clamp.....	559	Converse Skin Hooks.....	185
Circumcision Clamps.....	269	Cooley Anastomosis Clamps.....	596
Cooley Vascular Clamps.....	622	Cooley Aorta Clamp.....	648
CVT.....	544	Cooley Carotid, Subclavian and Renal Clamp.....	622
Femoral-Popliteal Clamps.....	612	Cooley Clamps.....	597
Gastrointestinal Forceps and Clamps.....	87	Cooley Clamps For Pediatric and Infant Cardiovascular Surgery.....	597
General.....	25	Cooley Clamps For Pediatric Cardiovascular Surgery.....	595
Hemostatic Forceps and Clamps.....	56	Cooley Coarctation Clamps.....	623
Micro Vessel Clamps.....	568	Cooley Dilators.....	768
OB/GYN.....	262	Cooley Iliac Clamps.....	623
Pediatric Clamps, 1 mm Jaw.....	575	Cooley Jaw Multipurpose Clamps.....	624
Pediatric Clamps, 1.5 mm Jaw.....	577	Cooley Jaw Vascular Tissue Forceps.....	547
Pediatric Clamps, 2 mm Jaw.....	589	Cooley-Mayo Curved Scissors.....	118
Pediatric Clamps, Cooley-Type Jaw.....	595	Cooley Mitral Valve Retractors.....	751
Pediatric Vascular Clamps.....	693	Cooley Partial-Occlusion Clamps.....	625
Peripheral Vascular Clamps.....	613	Cooley Patent-Ductus Clamps.....	626
Rectal.....	298	Cooley Pediatric Cardiovascular Clamps.....	598
Renal Clamps.....	610	Cooley Pediatric Derra Clamps.....	599
Right Angle Clamps.....	76	Cooley Pediatric Modified Anastomosis Clamp.....	600
Ring Handled Bulldog® Clamps.....	602	Cooley Pediatric Multipurpose Clamps.....	600
Towel Clamps.....	29	Cooley Pediatric Patent Ductus Clamps.....	601
Tubing Clamps.....	26	Cooley Peripheral Vascular Clamps.....	627
Vascular Clamps.....	573, 696	Cooley Scissors.....	256
Clark Artery Forceps.....	251	Cooley Sternum Retractors.....	733
Clark Hysterectomy Clamps.....	254	Cooley Sump Suction Tube.....	247, 765
Claw Grasper.....	1135	Cooley Titanium Pediatric Clamp.....	695
Cleaners and Lubricants.....	345	Cooley Vena Cava Clamps.....	627
Cleanpunch® Cleaning System.....	1049, 1085	Corn Knives.....	1096
Clerf-Arrowsmith Safety Pin Closing Forceps.....	455	Coronary Potts Scissors.....	661
Cleveland Bone Cutting Forceps.....	1019	Coronary Ultra Fine Tissue Forceps.....	54, 547
Cleveland Clinic Renal Clamps.....	610	Coryllos-Bethune Rib Shears.....	718
<b>Clips and Appliers</b> .....	779	Cottle Alar Retractor.....	196
Mediastinoscopy.....	779	Cottle Columella Forceps.....	507, 1111
Micro Clips and Appliers.....	315	Cottle Double Ended Elevator.....	503, 959
Cloward-Style Mallets.....	1016	Cottle Knife Guide and Retractor.....	508
Coagulation Suction Tubes.....	1161	Cottle Nasal Knife.....	508
Coarctation Hook.....	758	Cottle Osteotomes.....	508
Cobb Curettes, Aluminum Handle.....	982	Cottle Rasp.....	510, 975
Cobb Curettes, Stainless Steel Handle.....	983	Cottle Septum Speculum.....	519
Cobb Osteotome.....	999	Cottle Skin Hooks.....	185
Cobb Smartrack For 11" Instruments.....	991, 1087	Couëtil Ima Sternal Retractor.....	723
Cobb Spinal Elevators, Aluminum Handle.....	966	Cox Metatarsal Spreader.....	901
Cobb Spinal Elevators, Hex Handle.....	965	Cradles and Holders.....	370
Cobb Spinal Elevators, Stainless Steel Handle.....	967	Crafoord Coarctation Vascular Clamps.....	631
Cobb-Type Spinal Gouges.....	1008	Crafoord Tissue Forceps.....	54
Colibri Corneal Tissue Forceps.....	1104	Crafoord Titanium Clamping Forceps.....	696
Coller Forceps.....	59	Crawford Aortic Retractors.....	751
Collier Anderson Clamps.....	252		





Crawford-Cooley Graft Tunneler.....	796
Crawford Suture Ring.....	756
Crawford Thoraco-Abdominal Aneurysm Clamps .....	648
Crego Periosteal Elevator.....	962
Crile Forceps.....	60
Crile Hemostats .....	60
Crile Murray Bulldog® Needle Holders.....	162
Crile Retractor .....	203
Crile Titanium Hemostatic Forceps .....	692
Crile Wood Bulldog® Needle Holders .....	162
Crile Wood Needle Holders.....	161, 259
Crouch Clamp .....	76
Crown Fixator .....	816
Cruciform Screwdriver .....	873
Crutchfield Tongs .....	917
<b>Curettes.....</b>	<b>979</b>
Brun Curettes .....	979
Cobb Curettes.....	982
Ear Curettes.....	493
Endoscopic Curettes .....	989
OB/GYN Curettes .....	275
Ophthalmic .....	1124
Specialty Bone Curettes.....	984
Curette Excavators .....	1095
Curved Masher Grasping Forceps .....	781
Cushing Bayonet Dressing Forceps.....	37
Cushing Bayonet Tissue Forceps.....	47
Cushing Blunt Elevator.....	717
Cushing Decompression Retractor.....	196, 745
Cushing Dressing Forceps .....	36
Cushing Gutsch Bayonet Dressing Forceps .....	37
Cushing Gutsch Dressing Forceps.....	36
Cushing Gutsch Tissue Forceps.....	47
Cushing IVD Rongeurs.....	1061
Cushing Little Joker Elevator .....	961
Cushing Nerve and Vein Retractor .....	197, 745
Cushing Periosteal Elevators .....	961
Cushing Tissue Forceps .....	47
Cushing Titanium Dressing Forceps.....	687
Cushing Titanium Tissue Forceps .....	687
Cushing Vein Retractors.....	261
<b>Customer Service.....</b>	<b>8</b>
Cutting Block.....	520, 1130
<b>CVT Forceps and Clamps .....</b>	<b>544</b>
Bronchus and Lung Clamps .....	555
Chest Drain Pulling Clamp .....	559
Ligature Carriers .....	553
Micro Forceps.....	550
Tissue Forceps.....	544
<b>CVT Needle Holders .....</b>	<b>674</b>
Castro-Type Micro Needle Holders .....	681
Pilling® Technique® Design.....	674
Wire Twisters.....	684
<b>CVT Retractors.....</b>	<b>720</b>
Epicardial.....	720
Hand-Held.....	744
Henly-Type Retractors.....	748
IMA .....	720
Sternal Retractors/Rib Spreaders.....	727
Pilling® Sternal Retractor and Rib Spreader Dimensions .....	741
Sternal Closure .....	743
C.W. Mayo Tissue Forceps.....	55
Cylindrical Sponges.....	357
Cystic Duct Catheter Clamps .....	93
<b>D</b>	
Dale Femoral-Popliteal Anastomosis Clamps.....	612
Dale Femoral-Popliteal Clamps.....	612
Dale First Rib Rongeur .....	714
Dandy Hemostatic Forceps.....	61
Dandy Kolodny Forceps .....	61
Dandy Nerve Hook .....	190
Darling Tape Passing Clamp "Aorta Go Around" .....	553
Darrach Elevators .....	968
Davidson Scapula Retractors .....	215, 746
Davis Brain Spatulas.....	214
Davis-Finochietto Infant Retractor .....	727
Davis & Mcivor Left Tongue Blades.....	524
Davis & Mcivor Right Tongue Blades.....	525
Davis Mouth Gag Blade, Size 2 .....	525
Davis Mouth Gags.....	526
Davis Retractors .....	203
Davis Tissue Forceps.....	55
Day Ear Hook.....	493
Dean (Blumenthal) Rongeurs.....	1029
Dean Rongeur .....	1027
Dean Scissors .....	121
Dean Tonsil Scissors.....	530
Deaver Retractors.....	207
DeBakey® Acutely Curved Clamps .....	591
DeBakey®-Adson Coronary Suction Tubes .....	248, 766
DeBakey® Angled Peripheral Vascular Clamp .....	614
DeBakey® Aorta Clamp.....	649
DeBakey® Aortic Aneurysm Clamps .....	650
DeBakey® Aortic Exclusion Clamp .....	614
DeBakey® Bainbridge Clamps .....	92
DeBakey® Bainbridge Vascular Clamps .....	615
DeBakey® Carbide Forceps .....	49, 545
DeBakey® Chest Retractors.....	734
DeBakey® Child Retractor .....	729
DeBakey® Coarctation Clamps .....	577, 616
DeBakey® Cooley Retractor .....	210
DeBakey® Cross Action Bulldog® Clamps.....	560
DeBakey® Curved Clamps.....	651
DeBakey® Curved Peripheral Vascular Clamp.....	616
DeBakey® Diethrich Delicate Vascular Tissue Forceps..	48, 546
DeBakey® Diethrich Dlama-Grip Tissue Forceps .....	546
DeBakey® Endarterectomy Scissors .....	667
DeBakey® Femoral Bypass Tunneler.....	796
DeBakey® Fiberoptic Illuminated Suction Tube .....	247
DeBakey® Full Curved Aortic Aneurysm Clamps .....	652
DeBakey® Gelpi Retractor, Short Model .....	224
DeBakey® Grasper .....	1145
DeBakey® Hysterectomy Clamp .....	265
DeBakey® Lung Grasping Forceps.....	556
DeBakey®-Metzenbaum Dissecting Scissors.....	127, 668
DeBakey® Miniature Anastomosis Clamp .....	591
DeBakey® Modified Semb Ligature Carrier .....	553
DeBakey® Multi-Purpose Angled Clamps .....	632
DeBakey® Multipurpose Vascular Clamps .....	580
DeBakey® Multipurpose Vascular Clamps Long.....	581
DeBakey® Partial Occlusion Clamps .....	578
DeBakey® Patent Ductus Clamps .....	584, 617
DeBakey® Pediatric and Adult Vascular Clamps.....	582
DeBakey® Pediatric Multipurpose Clamps.....	592
DeBakey® Potts Scissors .....	658
DeBakey® Renal Artery Clamp .....	611



Debakey® Right Angle Forceps.....	76	Fiber Optic Lighting.....	215
Debakey® Ring Handle Bulldog® Clamps.....	602	Diamond Pin Cutter.....	828
Debakey® Scissors.....	127, 667	Diethrich Bulldog® Clamps.....	561
Debakey® Spoon Clamps.....	579	Diethrich Caval Occlusion Clamp.....	619
Debakey® "S" Shaped Peripheral Vascular Clamp.....	613	Diethrich Coronary Artery Clamp.....	619
Debakey® Suction Tubes.....	247, 766	Diethrich Delicate Angled Coronary Scissors.....	662
Debakey® Tangential Occlusion Clamps.....	633	Diethrich-Potts Vascular Scissors.....	662
Debakey® Technique® Needle Holders.....	170, 674	Diethrich Right Angle Clamps.....	77
Debakey® Thoracic Dissecting Forceps.....	94	Digitate®-Heifetz Needle Holders.....	684, 1121
Debakey® Thoracic Tissue Forceps.....	47, 544	Digitate®-Heifetz Scissors.....	132, 1116
Debakey® Tissue Forceps.....	250	Dilator Instrument Trays.....	323
Debakey® Titanium Bulldog® Clamps.....	703	<b>Dilators</b> .....	
Debakey® Titanium Needle Holder.....	709	Amato Design, Vascular.....	768
Debakey® Titanium Pediatric Clamps.....	695	Cooley Design, Vascular.....	768
Debakey® Titanium Ring Handle Needle Holders.....	709	DeBakey® Design, Vascular.....	769
Debakey® Titanium Tissue Forceps.....	50, 688	Dilators, Sounds and Needles.....	295
Debakey® Titanium Vascular Clamps.....	697	Esophageal Bougies.....	465
Debakey® Ultralight Forceps.....	48, 545	Garrett Design, Vascular.....	770
Debakey® Valve Hooks.....	758	Hiebert Design, Vascular.....	771
Debakey® Valve Scissors.....	668	Laryngeal Dilators.....	468
Debakey® Vascular Dilators.....	769	OB/GYN.....	272
Debakey® Vascular Scissors.....	659	Ophthalmic.....	1126
Debakey® Vascular Tissue Forceps.....	48, 544	Tracheal Dilators.....	489
Deborah-Castaneda Partial Occlusion Clamps.....	585	Valve Dilators.....	760
Deborah-Castaneda Peripheral Vascular Clamps.....	586	Dingman Forceps.....	947
Decannulation Stoppers.....	488	Dingman Mouth Gag.....	526
Decker IVD Rongeur.....	1060	Dingman Zygoma Hook.....	192
Dedo Double-Action Anterior Commissure		<b>Dissectors and Elevators</b> .....	953
Laryngoscopes.....	404	Cobb Elevators.....	965
Dedo Laser Micro-Laryngoscope.....	400	Double Ended Elevators.....	957
Dedo-Pilling® Laser Laryngoscope Extra-Long.....	401	Enderectomy Dissectors.....	793
Dedo-Pilling® Micro-Laryngoscope.....	396	Endoscopic Elevators.....	967
Dedo Table-Mounted Mayo Tray.....	412	Laparoscopic Dissector.....	1135
Deep Deaver Retractors.....	209	Metatarsal Elevators.....	958
Deep Rake Retractors.....	194, 886	Penfield Elevators/Dissectors.....	956
Deklene® Maxx™ Polypropylene Suture.....	1164	Periosteal Elevators.....	959
De Lee Cervical Grasping Forceps.....	262	Specialty Elevators.....	968
De Lee Obstetrical Forceps.....	270	Dittel Urethral Sounds.....	295
De Lee Universal Retractor.....	286	Dix Spud and Needles.....	1127
Delicate Center-Action Bronchoscopic Forceps.....	459	Doering Carotid End Point Micro Rongeur Forceps.....	607
Delicate Operating Scissors.....	112	Double Action Pin Cutter.....	828
Delicate Wire Cutter.....	823	Double Action Wire Cutters.....	825
Demartel Acutely Angled Scissors.....	127	Double Action Wire Extraction Pliers.....	841
Demartel Scissors.....	128	Double Drill Sleeves.....	864
Demel Wire Guides.....	848	Double Ended Probes.....	307
Demos Tibial Artery Clamp.....	613	Douglas Cilia Forceps.....	1109
Denhardt Mouth Gag.....	528	Downing Cartilage Knife.....	950
Denis Micro Ring Forceps.....	553	Doyen Abdominal Scissors.....	118
Denis Titanium Micro Forceps.....	690	Doyen Ferguson Scissors.....	119
Dennis Anastomosis Clamp.....	95	Doyen Intestinal Clamps.....	95
Derf Needle Holders.....	151	Doyen Raspatories.....	717
Derf Needle Holder Standard - Stainless Steel Jaw.....	152	Doyen Retractors.....	210
Derf Titanium Ring Handle Needle Holder.....	710	Doyen Scissors.....	119
Dermal Instruments.....	312	Dressing Forceps.....	38, 1102
Derra Miniature Anastomosis Clamps.....	618	<b>Drills, Drill Bits and Guides</b> .....	850
Derra Partial Occlusion Clamps.....	587	Adapters.....	856
Derra Titanium Anastomosis Clamps.....	696	Countersinks.....	860
D'errico-Adson Retractor.....	904	Guides and Sleeves.....	863
Deschamps Ligature Carriers.....	314	Jacobs Chuck End.....	858
Desjardin Gallstone Grasping Forceps.....	95	Quick Coupling End.....	858
Desmarres Chalazion Forceps.....	1110	Quick Coupling Handles.....	856
Desmarres Lid Retractors.....	197	Taps.....	861
Desmarre Valve Retractors.....	752	Three-Fluted Drill Bits.....	859
Devine-Millard-Aufrecht Nasal Retractor		Dual Cup Grasper.....	1143



Duffield Scissors.....	137
Duplay Tenaculum.....	279
Duval Lung Tissue Forceps.....	556

## E

<b>Ear Instruments</b> .....	493
Curettes.....	493
Elevators.....	494
Forceps.....	494
Miscellaneous.....	501
Scissors.....	498
Specula.....	499
Ear Knife Blades.....	501
Eastman Vaginal Retractors.....	286
Echlin Duckbill Rongeurs.....	1041
Edna Non-Perforating Towel Clamps.....	29
Edna Towel Forceps.....	29
Effler-Groves Double-End Dissector and Hook.....	793
Effler-Groves Special Lightweight Bulldog® Clamp.....	561
EFx™ Endo Fascial Closure System.....	1168
Electrode Handle.....	1150
Electrode Tips.....	1150
<b>Electrosurgery</b> .....	1156
Bipolar Forceps and Cords.....	1156
Coagulation Suction Tubes.....	1161
Disposable Electrodes.....	1159
Electrodes.....	1160
Monopolar Handswitching Forceps.....	1160
<b>Elevators</b> .....	494
Cobb Elevators.....	965
Double Ended Elevators.....	957
Ear Elevators.....	494
Endoscopic Elevators.....	967
Metatarsal Elevators.....	958
Nasal Elevators.....	503
Penfield Elevators/Dissectors.....	956
Periosteal Elevators.....	959
Specialty Elevators.....	968
Elliot Obstetrical Forceps.....	270
Emesis Basins.....	338
Emmett Uterine Probe.....	272
Emmett Uterine Tenaculum Hooks.....	291
Endaural Ear Speculum.....	501
End Cutter.....	828
Endo Brun Curettes.....	989
Endo Cone Ring Curettes.....	990
Endo Epstein Curettes.....	990
Endoscopic Bone Tamp.....	1010
Endoscopic Cobb Elevators.....	967
Endoscopic Penfield Elevator.....	968
Endoscopic Rib Elevators.....	968
Endo Scoville Curette.....	990
Engel Plaster Saw.....	1081
Eppendorfer Biopsy Punch.....	266
Epstein Curettes.....	984
Esmarch Bandage Scissors.....	101
Esmarch Plaster Shears.....	101
<b>Esophagoscopes</b> .....	447
Holinger Design.....	448
Jackson Design.....	449
Jesberg Design.....	447
Pillsbury-Jesberg Design.....	447

Specula.....	450
Ethmoid Punch.....	516
Eve Tonsil Snare.....	531
Ewald Dressing Forceps.....	35
Ewald Tissue Forceps.....	45
Example Clamp.....	607
Excavator and Packer.....	1094
Excavator and Probe.....	1095
<b>Extended Length/Open Bariatric</b> .....	249
Forceps and Clamps.....	249
Knife Handles/Suction Tubes.....	249
Needle Holders.....	259
Retractors.....	261
Scissors.....	256
Extra Light Technique® Needle Holders.....	172, 676
Extra-Lightweight Construction Forceps.....	451
Extra Long Center Blades.....	229
Eye Scissors.....	1118
Eye Shields.....	1131
Eye Spuds/Needles.....	1127

## F

Face Lift Retractor Fiberoptic Lighting On #2	
Deaver Retractor.....	215
Fansler-Ives Rectal Specula.....	303
Fansler Operating Speculum.....	303
Farabeuf Bone Holding Forceps.....	924
Farabeuf-Lambotte Bone Holding Forceps.....	925
Farabeuf Periosteal Rasps.....	978
Farabeuf Retractors.....	203
Farrell (Lathbury) Applicator.....	501
Farrell Rubio Retractor.....	738
Farr Retractors.....	500
Favaloro-Semb Ligature Carriers.....	216
Favaloro-Morse Sternal Retractors.....	554
Favaloro Proximal Anastomosis Clamp.....	733
Feder-Ossoff Micro-Laryngeal Grasping Forceps.....	633
Feder-Ossoff Micro-Laryngeal Scissors.....	420
Feder-Ossoff Phonosurgery Instrument Sterilizing Tray.....	422
Feder-Ossoff Phonosurgery Set.....	424
Feilchenfeld Splinter Forceps.....	421
Female Catheter Silvers.....	32
Ferguson Angiotribe Forceps.....	297
Ferguson-Frazier Suction Tubes.....	298
Ferguson Long Dissecting Scissors.....	243
Fergusson Bone Holding Forceps.....	128, 668
Ferris-Smith Endoscopic IVD Rongeurs.....	925
Ferris-Smith Endoscopic Kerrison Rongeurs.....	1065
Ferris-Smith Ivd Rongeurs.....	1058
Ferris-Smith Kerrison Punches.....	1065
Ferris-Smith Kerrison Rongeurs.....	1057
Ferris Smith Tissue Forceps.....	1056
Fess Sinoscopy Forceps.....	50
Fiber Optic Cables.....	514
Fiber Optic Instrument Cable End Adapters.....	463
Fibula Bone Holding Forceps.....	464
Files.....	925
Filters.....	970
Fine Stitch Scissors.....	371
Finger Ring Cutters.....	1114
Finochietto Needle Holder.....	1092
	170





Gilles Titanium Tissue Forceps.....	689	Haight Retractors .....	214, 746
Gillies Converse Skin Hooks.....	186	Haimovici Scissors .....	669
Gillies Hooks.....	882	Hallman Tunneling Forceps .....	797
Gillies Needle Holder Scissors.....	153	Halsey Needle Holders.....	153
Gillies Zygoma Elevator.....	504	Halsey Titanium Ring Handle Needle Holder.....	710
Glenoid Perforating Forceps.....	918	Halsted Mosquito Forceps .....	62
Glover Atrial Appendage Clamp.....	634	Halsted Mosquito Forceps With Teeth .....	62
Glover Coarctation Clamps .....	635	Halsted Titanium Hemostatic Forceps .....	692
Glover Curved Clamps.....	636	Hamburger-Brennan-Mahorner Retractor .....	237
Glover Curved Miniature Pediatric Clamp.....	593	Hand-Held Rod Cutter.....	833
Glover Patent Ductus Clamps .....	636	Hank Uterine Dilators.....	273
Glover Right Angle Curved Clamps .....	637	Harken Clamps .....	638
Glover Spoon Shaped Clamps.....	637	Harrington Clamps .....	78
Glover Style Bulldog® Clamps.....	562	Harrington Extra Deep Retractors .....	210
Glover Titanium Auricular Clamp .....	699	Harrington Retractors.....	210
Glover Titanium Coarctation Vascular Clamps.....	699	Harrington Spinal Elevator.....	969
Goelet Retractor .....	204	Harrington Splanchnic Retractors .....	211
Goldman-Fox Scissors.....	143	Hartman Mosquito Forceps .....	63
Goldman Septum Displacer.....	503	Hartmann Alligator Forceps.....	495
Golf Stick Knives.....	1096	Hartmann Ear Dressing Forceps .....	495
Gomco® Circumcision Clamps .....	269	Hartmann Ear Speculum .....	500
Gomez/Poly-Tract Poly Clamps.....	242	Hartmann-Herzfeld Cup Forceps.....	497
Gordon Bead Grasping Forceps.....	455	Hartman Rongeur .....	1030
Gorney Rhytidectomy Scissors.....	121	Hasson "S" .....	1153
Gouges .....	1005	Hatfield Bone Curettes .....	985
Goulian Depth Gauge and Guards .....	24	Haverfield-Scoville Hemilaminectomy Retractor Body.....	913
Goulian Skin Graft Knife Set .....	23	Hayes Anterior Resection Clamps .....	96
Grabber Fenestrated Forceps.....	1143	Hayes Hand Retractors .....	895
Gradle Scissors.....	134, 1119	Healon Injection Cannula.....	1128
Graefe Eye Dressing Forceps.....	1103	Healy-Jako Pediatric Subglottiscope .....	406
Graefe Eye Speculum .....	1125	Heaney-Ballantine Hysterectomy Clamps.....	266
Graefe Fixation Forceps.....	1111	Heaney Ballentine Clamps .....	255
Graefe Strabismus Hooks.....	1122	Heaney Biopsy Curette.....	275
Graefe Tissue Forceps.....	51	Heaney Bulldog® Needle Holder.....	166
Grant Abdominal Aortic Aneurysm Clamps, "Texas Twister" .....	653	Heaney Hysterectomy Forceps.....	265
Graves Vaginal Specula.....	283	Heaney Needle Holders.....	166, 259
Gray Cystic Duct Forceps.....	78	Heaney-Simon Vaginal Retractor.....	286
Green Retractor.....	197	Heath Mallet .....	1017
Greg Comdone Extractor .....	312	Heath Suture and Wire Cutting Scissors.....	111
Gregory Carotid Angled Bulldog® Clamp .....	604	Heavy Duty Locking Pliers.....	843
Gregory Internal Carotid "Soft" Bulldog® Clamp.....	604	Hegar Baumgartner Needle Holders.....	163
Gregory Miniature Vascular Clamps.....	603	Hegar Uterine Dilators .....	274
Gregory Profunda Clamps.....	620	Heiss Retractors .....	217
Gregory Technique® Suture "Stay" Clamps .....	184, 679	Heiss Titanium Clamping Forceps.....	699
Grieshaber Wire Retractors .....	216	Heitmiller Mini Thoracotomy Retractor .....	740, 780
Grooved Director and Tongue Ties.....	307	Hemoclip® Clips and Appliers.....	384
Grooved Directors .....	307	Hemoclip® Plus.....	382
Gross Spoon and Hook.....	502	Hemoclip® Traditional .....	382
Gruber Ear Speculum.....	501	Hem-o-Lok® Endoscopic Appliers .....	375
Gruenwald Bayonet Forceps.....	38	Hem-o-lok® Open Appliers.....	375
Grunwald Suture Guide Holder.....	756	Hem-o-Lok® Polymer Ligating Clips.....	376
<b>Guarantee/Warranty.....</b>	<b>9</b>	Henly Popliteal Retractor .....	227
Guidewire with Drillpoint.....	866	Henly Subclavian Artery Clamp .....	621
Guilmet Titanium Dressing Forceps .....	690	Hennig Plaster Spreader .....	1079
Gunnar Roller Clamps.....	26	Henroten Vulsellum.....	281
Gut and Colon Clamps.....	99	Henroten Weighted Vaginal Speculum.....	285
Guthrie Skin Hook .....	186	Heparin Cannula With Luer-Lok .....	764
Guyon Catheter Guide .....	297	Hepp-Scheidel Dissecting Scissors .....	1116
		Hercules Plaster Scissors.....	101
		Herrick Kidney Clamp .....	292
		Hess Angular Mosquito Tip Serrefine .....	563
		Hexagonal Screwdrivers .....	869
		Hexagonal Screwdriver Shaft .....	871
		Hexagonal Screwdriver Shaft (Pelvic) .....	869

## H

Haight Baby Retractor.....730





Hex-Handle Osteotomes .....	509	Hudson Tissue Forceps.....	45
Hibbs and Brun Smartrack For 9" Instruments .....	991, 1088	Hufnagel Aorta Clamps.....	639
Hibbs Blades.....	914	Hufnagel Titanium Vascular Clamp .....	700
Hibbs Chisels .....	1003	Hulka Tenaculum and Probe .....	279
Hibbs Endoscopic Gouge .....	1008	Humeral Head Retractor .....	892
Hibbs Endoscopic Osteotome.....	998	Hurd Dissector and Pillar Retractor .....	529
Hibbs Gouges .....	1007	Hurst Tungsten-Filled Esophageal Bougies .....	465
Hibbs Osteotomes .....	998	Hysterectomy Scissors.....	257
Hibbs Retractors.....	888		
Hiebert Double-Ended Vascular Dilators .....	771		
High Mayo Perforated Trays .....	326		
Hi-Level Bandage Scissors.....	102		
Hill Ferguson Rectal Retractors.....	301		
Hill Stitch Scissors.....	106		
Hirschman Anoscopes.....	305		
Hoen Alligator Forceps .....	948		
Hoen Hooks .....	883		
Hohmann Retractors .....	896		
Hoke Chisels .....	1003		
Hoke Osteotomes .....	995		
Holinger Anterior Commissure Laryngoscopes.....	393		
Holinger Aspirating Tubes .....	461		
Holinger Cup Biting Specimen Forceps .....	452		
Holinger Fiberoptic Esophagosopes.....	448		
Holinger "Hour Glass" Anterior Commissure Laryngoscopes .....	394		
Holinger Infant Esophageal Speculum .....	450		
Holinger Infant (Newborn) Slide Laryngoscope .....	390		
Holinger Knife Handle.....	434, 533		
Holinger Laryngeal Knife Handle .....	24		
Holinger Laryngectomy Tubes.....	485		
Holinger "Slotted" Anterior Commissure Laryngoscope .....	394		
Holinger Tracheostomy Tube.....	482		
Holinger Ventilating Fiberoptic Bronchoscope.....	438		
Hollinger Laryngeal Dissector.....	434		
Holman Scope Brushes .....	445		
Holman Scope Brushes - For Bronchoscopes and Esophagosopes .....	492		
Holman Trachea Tube Brushes .....	492		
Holsher Nerve Retractors .....	884		
Hook Biopsy Punch .....	1140		
Hook Scissors .....	1148		
<b>Hooks</b> .....	1122		
Bone Hooks.....	942		
Lens Hooks .....	1122		
Muscle Hooks .....	1123		
Ophthalmic .....	1122		
Strabismus Hooks.....	1122		
Valve Hooks .....	758		
Horizon™ Cartridge.....	378		
Horizon™ Clips .....	378		
Horizon™ 11" Multi-Angle Access Open Surgical Applier.....	379		
Horizon™ Endosaphenous Vein Applier .....	379		
Horizontal Retractor.....	908		
House Alligator Forceps.....	495		
House Bellucci Mini Alligator Scissors.....	499		
House Curettes.....	494		
House Retractor.....	494		
House Strut Forceps.....	496		
Howard-Debakey® Aortic Aneurysm Clamps .....	653		
Howell Coronary Technique® Needle Holder .....	171, 675		
Howell Valve Technique® Needle Holder .....	171, 675		
Hudson Drill and Burrs .....	854		
Hudson Drill Bits .....	855		
		IMA Retractor.....	723
		Impactor/Bone.....	1009
		Improved Balfour Retractors Interchangeable Side Blade Model.....	231
		Improved Henly Retractors.....	227, 749
		Improved Henly Retractor Side Blades.....	228, 749
		Improved Holinger Ventilating Fiberoptic Bronchoscopes .....	439
		Improved Tucker Mediastinoscope.....	774
		In-Ex Adson Dressing Forceps .....	349
		In-Ex Adson Tissue Forceps .....	349
		In-Ex Allis Tissue Forceps.....	352
		In-Ex Backhaus Towel Clamps.....	350
		In-Ex Baumgartner Needle Holders.....	353
		In-Ex Bozeman Uterine Dressing Forceps .....	353
		In-Ex Crile Forceps.....	351
		In-Ex Edna Towel Clamp .....	350
		In-Ex Halsted Mosquito Forceps .....	351
		In-Ex Hoff Towel Clamp .....	350
		In-Ex Iris Scissors.....	355
		In-Ex Kelly Forceps .....	352
		In-Ex Lister Bandage Scissors .....	354
		In-Ex Littauer Suture Scissors.....	354
		In-Ex Mayo Hegar Needle Holders.....	354
		In-Ex Mayo Scissors.....	356
		In-Ex Operating Scissors .....	355
		In-Ex Rochester-Pean Forceps.....	352
		In-Ex Sponge Forceps.....	351
		In-Ex Thumb Forceps.....	349
		In-Ex Webster Needle Holder .....	353
		In-Ex Wire Scissors.....	355
		Infant Retractor .....	204
		Inge Retractor.....	910
		Ingrown Nail Forceps.....	1072
		Ingrown Nail Instrument #81.....	1073
		Ingrown Nail Splitting Scissors .....	1074
		Initial Incision (Charnley) Retractor.....	911
		Inline Ratcheted Handle.....	1134
		Insert Drill Sleeve .....	865
		<i>In Situ</i> Rod Benders .....	877
		<i>In Situ</i> Venous Valvulotome.....	773
		<i>In Situ</i> Venous Valvulotome Sterilizing Case .....	772
		<b>Instrument Accessories</b> .....	329
		Bowls.....	338
		Brushes.....	344, 444, 445, 492
		Cleaners and Lubricants .....	343
		Containers and Trays.....	322
		Instrument Holders and Stringers .....	339
		Miscellaneous .....	348
		Sterilization Case and Tray Solutions .....	329
		Instrument Cleaning Brushes .....	344
		Instrument Flat Packs.....	1090





Jarcho Tenaculum.....	279	Keyhole Brackets.....	336
Javid Carotid Shunt Clamps.....	605	Key Periosteal Elevator.....	960
Jehle Sterile Coronary Catheters.....	761	Killian Nasal Speculums.....	518
Jennings Mouth Gag.....	527	Kirklin Sternal Awls.....	744
Jesberg Fenestrated Grasping Forceps.....	457	Kirk Mallet.....	1017
Jesberg Oval Esophagoscopes.....	447	Kirmission Periosteal Rasp.....	978
Jeweler's Forceps.....	1108	Kirschner Bows.....	848
Johns Hopkins (Blalock) Bulldog® Clamps.....	564	Kirschner Drill Set.....	853
Johnson Bulldog® Needle Holder.....	154	Kleinert-Kutz Bone Rasp.....	976
Johnson Needle Holder.....	154	Kleinert-Kutz Double Action Rongeur.....	1034
Johnson Neuroma Retractor.....	226	Kleinert-Kutz Elevator and Dissector.....	504, 957
Johnson Skin Hook.....	187	Kleinert-Kutz Micro Clip Applying Forceps.....	319, 568
Johnson-Tucker Hook and Fork.....	1093	Kleinert-Kutz Micro Vessel Clips.....	315, 567
Jones Cross-Action Towel Forceps.....	31	Kleinert-Kutz Rasp.....	511, 976
Jones Hemostat.....	65	Kleinert-Kutz Skin Hooks.....	187
Jorgenson Scissors.....	120, 257	Kleinert-Kutz Synovectomy Rongeur.....	1026, 1032
Joseph Bone Saws.....	1076	Kleinert-Kutz Tendon Retrievers.....	949
Joseph Periosteal Elevator.....	504	Kleinert-Ragnell Retractor.....	202
Joseph Rasp.....	510, 975	Kleinert-Kutz Hook.....	188
Joseph Scissors.....	136	Klintermalm™ Liver Transplant Clamps.....	96
Joseph Skin Hooks.....	187	KMedic® Cable Cutter.....	832
Judd-Allis Intestinal Forceps.....	89	KMedic® Cast Spreader.....	1080
Julian Needle Holder.....	172	KMedic® CleanPunch® Rongeurs.....	1047
<b>K</b>			
Kahler Grasping Forceps.....	458	KMedic® Comdone Extractor (Walton).....	313
Kaiser-Pilling® Andrews Suction.....	791	KMedic® Corwin Wire Twister.....	819
Kaiser-Pilling® Angle Sickle Knife.....	790	KMedic® Drill Bit Sterilization Case.....	857
Kaiser-Pilling® Biopsy Forceps.....	790	KMedic® End Cutter.....	827
Kaiser-Pilling® Blunt Hook.....	790	KMedic® Gratloch™ Wire Bender.....	814
Kaiser-Pilling® Hook.....	791	KMedic® Jet Wire Twister.....	821
Kaiser-Pilling® Spatula.....	791	KMedic® Large Pin Cutter.....	830
Kaiser-Pilling® Sterilizing Tray.....	792	KMedic® P.I. Wire Twister and Tightener.....	820
Kaiser-Pilling® Suction With Thumb Valve.....	792	KMedic® Side Cutter.....	824
Kaiser-Pilling® Debakey®-Type Allis Ring Forceps.....	789	KMedic® Skin Hook.....	188
Kaiser-Pilling® Debakey®-Type Ring Forceps.....	789	KMedic® Spinal Rongeurs and Punches.....	1045
Kaiser-Pilling® Long Jaw Ring Forceps.....	787	KMedic® Utility Shears.....	102
Kaiser-Pilling® Short Jaw Ring Forceps.....	786	KMedic® Wire and Pin Drivers and Benders.....	811
Kaiser-Pilling® Thoracoscopic Forceps.....	788	KMedic® Wire and Pin Implants.....	806
Kantrowitz Forceps.....	79	KMedic® Wire Cutter With Safety Inserts.....	825
Kantrowitz Right Angle Forceps.....	252	Knapp Iris Scissors.....	137
Kartchner Internal Carotid Clamp.....	608	<b>Knife Handles</b> .....	22
Kay Aortic Anastomosis Clamp.....	641	Extended Length/Open Bariatric.....	249
Kaye Scissors.....	136	General.....	22
Kay-Lambert Aortic Anastomosis Clamp.....	640	Specialty.....	23
Kay Titanium Vascular Clamp.....	700	<b>Knives</b> .....	1125
"K" Dissector Sponges.....	359	Cartilage Knives.....	950
Kelly Fistula Scissors.....	137	Nasal Knives.....	508
Kelly Forceps.....	65	Nucleus Knife.....	1125
Kelly Placenta Clamp.....	262	Ophthalmic.....	1125
Kelly Retractors.....	211	Knight Nasal Scissors.....	513
Kelly Vulsellum.....	281	Knives and Knife Handle.....	423
Kelman-Mcpherson Forceps.....	1106	Knot Pushers.....	1151
Kern Bone Holding Forceps.....	926	Knowles Bandage Scissors.....	102
Kerrison Cleanpunch® 2 Laminectomy Rongeurs.....	1049	Kocher Intestinal Clamps.....	97
Kerrison Multi-Bite Punches.....	1059	Kocker X-Action Forceps.....	253
Kerrison Rongeur.....	1058	Kogan Endocervical Speculum.....	284
Kerrison Thru-Cut Rongeur.....	515	Kolbel Soft Tissue Retractor.....	903
Kevorkian-Young Cervical Biopsy Forceps.....	267	Krause Nasal Snares.....	517
Kevorkian-Young Biopsy Curette.....	276	Kuntscher Diamond Pointed Awl.....	943
Kevorkian-Young Curettes.....	276	Kuntscher Extractors.....	1099
Keyes Dermal Skin Punches.....	313	Kuntscher Reamer.....	1099
		Kuntscher Skin Protector.....	1099
		Kuntscher X-Ray Scale.....	309, 1082
		Kuyper-Murphy Sternal Retractors.....	735
		K-Wire and Plate Bender.....	811





K-Wire Bender .....	811	Micro-Laryngoscopes/Binocular View .....	395
K-Wire End Cutter .....	827	Teeth Guards.....	389
K-Wire Extraction Pliers .....	839	Venturi Anesthesia Devices .....	414
K-Wire Side Cutter.....	824	Video Laryngoscopes.....	409
<b>L</b>			
Laborde Tracheal Dilator.....	489	<b>Laryngoscope and Instrumentation</b> .....	
Lacrimal Cannula.....	1128	Laser Instrumentation.....	430
Lacrimal Probe .....	1126	Micro-Laryngeal/Feder-Ossoff .....	420
La Force Adenotomes.....	521	Micro-Laryngeal/Jako .....	427
La Grange Scissors.....	138	Micro-Laryngeal/Jako-Kleinsasser .....	425
Lahey (Baby Metz) Scissors.....	122	Miscellaneous.....	434
Lahey Dissecting Forceps .....	80	Ossoff Double-Action Posterior Commissure	
Lahey Finger Retractors.....	192	Laryngoscope .....	405
Lahey Gall Duct Forceps, Slender Blades .....	80	Suction Tubes .....	419
Lahey Retractor .....	198	Laser Mirror.....	289
Lahey Traction Forceps.....	66	Laser Operating Platform - Ebonized .....	430
Lambert-Kay Aortic Anastomosis Clamp .....	640	Laser Spatula Retractors.....	430
Lambert-Lowman Bone Clamps.....	939	Laser Specula .....	290
Lambotte Bone Holding Forceps .....	926	Lawrence Fine Dissecting Forceps.....	782
Lambotte Osteotomes, Curved 9".....	994	Lawrence Hemostatic Forceps .....	66
Lambotte Osteotomes, Straight 7" .....	993	Lazy "S" .....	1153
Lambotte Osteotomes, Straight 9" .....	994	"L" Brackets.....	334
Lambotte-Style Osteotomes.....	509, 992	Lead Hands .....	1091
Lamina Spreaders.....	911	Lebsche Sternum Knife .....	719
Laminectomy Wedge Sponges.....	360	Lees Bronchus Clamps .....	557
Landreneau Thoracoscopy Tray.....	784	Lejeune Thoracic Forceps.....	57
Landreneau Thoroscopy Set .....	784	Leksell Rongeurs .....	1039
Lane Bone Holding Forceps.....	927	Leland Jones Clamps .....	97, 621
Lane Periosteal Elevator .....	962	Leland-Jones Titanium Vascular Clamps .....	701
Langenbeck Bone Holding Forceps.....	924	Lemmon Intima Dissectors .....	793
Langenbeck Metacarpal Saw .....	1076	Lemole-Pilling® Valve Retractor .....	753
Langenbeck Periosteal Elevator .....	962	Lemole Self Retaining Atrial Retractor.....	754
Langenbeck Retractors .....	198, 886	Lemole Side Arm Extension.....	755
Lap Chole Instrument Inserts .....	331	Lemole-Strong Aorta Clamps.....	641
<b>Laparoscopic Instruments</b> .....	1134	Lempert Rongeurs.....	1028
10 mm Dissectors.....	1138	Leur Rongeurs .....	1032
5 mm Bipolar Forceps .....	1141	Lewin Bone Holding Forceps.....	918
5 mm Dissectors, Grasping Forceps.....	1135	Lewis Rasps .....	976
5 mm Needle Holders.....	1147	Lewis Tonsil Snare.....	531
5 mm Ratcheted Graspers.....	1142	Lexer Chisels.....	1004
5 mm Scissors.....	1148	Lexer Mini Chisels.....	1004
5-10 mm Biopsy Forceps.....	1139	Ligation .....	373
Electrodes, Coagulators.....	1150	<b>Ligature Carriers</b> .....	319
Handle Types .....	1134	Ligature Carriers and Wire Passers.....	849
Retractors .....	1152	Miscellaneous.....	314
Telescopes .....	1151	Scope and Light Carriers Identification Index .....	534
Trays.....	1149	Lincoln-Metzenbaum Scissors.....	131
Large Countersink .....	861	Lincoln Scissors.....	131
Large Hexagonal Screwdriver .....	870	Lineman Pliers .....	840
Large Hexagonal Screwdriver (Pelvic) .....	870	Lister Bandage Scissors.....	103
Large Hex Screwdriver With Universal Joint .....	870	Liston Amputating Knives.....	1077
Large Hex Screwdriver W/ T-Handle.....	874	Liston Bone Cutting Forceps .....	1020
Larry Probe and Groove Director .....	306	Littauer Cilia Forceps .....	1110
Laryngeal Instrumentation For Laryngoscopes and		Littauer Standard Suture Scissors .....	106
Micro-Laryngoscopes .....	416	Littauer Stitch Scissors .....	106
Laryngeal Micro Atomizer .....	436	Littler Dissecting Scissors .....	1120
Laryngeal Mirrors.....	436, 524	Little Retractor .....	198
<b>Laryngoscope and Laser Laryngoscope</b> .....	388	Littler Stitch Scissors .....	107
Laryngoscope Holders .....	411	Litvak Preyra Ligature Needle .....	296
Laryngoscopes/Monocular View .....	389	Locke Elevators.....	1096
Laser Micro-Laryngoscopes .....	400	Locke Phalangeal Forceps.....	920



Long 1 mm Pediatric Clamps .....	575	Masterson Hysterectomy Forceps .....	255
Long Bevel Osteotomes.....	993	Mastin Muscle Forceps .....	66
Long, Double-Action Grasper .....	1143	Mayo Abdominal Retractor .....	211
Long Grasper, Double-Action .....	1142	Mayo Beveled Blade Scissors .....	114
Long Grasper, Single-Action.....	1142	Mayo Clinic Tube .....	482
Long Jaw Needle Nose Pliers.....	836	Mayo-Collins Retractors.....	204
Long, Single-Action Grasper.....	1143	Mayo Dissecting Scissors .....	115
Lore Subglottic Specimen and Tissue Forceps .....	418	Mayo Dissecting Scissors, TC.....	116
Lore Tube Holding Forceps.....	26	Mayo (Guyon) Vessel Clamp .....	98
Lothrop Uvula Retractor .....	529	Mayo-Harrington Scissors .....	117
Louisville Micro Vessel Approximator With Clips.....	316, 568	Mayo Harrington Super-Cut Scissors .....	257
Loutie Wire Tightener .....	817	Mayo Hegar Broad Bulldog® Needle Holders .....	165
Love-Gruenwald Ivd Rongeurs .....	1061	Mayo Hegar Needle Holders.....	163, 260
Love-Kerrison Laminectomy Punches.....	1051	Mayo Hegar Titanium Ring Handle Needle Holders.....	711
Love-Kerrison Rongeurs .....	1053	Mayo Masson Needle Holder.....	260
Lovelace Lung Tissue Forceps.....	557	Mayo Noble Scissors.....	117
Love Nerve Retractors .....	199	Mayo-Pean Forceps.....	67
Lower Gall Duct Forceps.....	81	Mayo-Robson Intestinal Clamps .....	98
Lowman Bone Clamps.....	939	Mayo Round Surface Blade Scissors .....	115
Lowsley Prostatic Retractors .....	297	Mayo Scissors.....	257
Lucae Bayonet Dressing Forceps .....	39	Mayo-Stille Scissors .....	117
Lucae Bone Mallets .....	1012	Mayo Trays.....	326
Luer-Lock Catheter Adapter.....	435, 767	Mayo Vessel Clamp.....	293
Luer Tracheostomy Tube.....	483	Mcallister Bulldog® Needle Holder.....	167
Lukens Thymus Retractor .....	204, 490	Mcburney Retractor .....	199
Lumbar and Cervical Impactors and Drivers.....	1010	Mcclean Obstetrical Forceps .....	270
Lumbar Lamina Spreaders.....	909	Mcclore Iris Scissors.....	132, 673, 1113
<b>M</b>			
Macquigg-Mixer Forceps.....	81	Mcdougal™ Prostatectomy Clamps.....	293
Magill Catheter Forceps.....	523	Mcgivney Forceps .....	299
Magnetic Instrument Mats.....	348	Mcglamery® Metatarsal Elevator.....	958
Mahorner Thyroid Retractor.....	237	Mcindoe Bone Cutting Forceps .....	1019
Maini Richardson Double Ended Center Blade For Henly Retractor.....	228, 750	Mcindoe Titanium Tissue Forceps.....	690
Maini Side Blade For Henly Retractor .....	228	Mcivor Mouth Gag.....	527
Maini Side Blade For Improved Henly Retractor .....	750	Mckenty Elevator.....	504, 959
Maki™ Scissors.....	105	Mclean-Tucker-Luikart Obstetrical Forceps.....	271
Malleolar Countersink .....	860	Mcpheerson Tissue Forceps .....	1105
Malleolar Bone Holding Forceps .....	921	Mead Mallet.....	1014
<b>Mallets</b> .....	1011	Mead Rongeur .....	1030
Heavyweight Mallets.....	1017	<b>Measuring Devices</b> .....	1082
Light and Medium Weight Mallets.....	1011	Calipers.....	1083
Mallet #49 .....	1012	Measuring Tape .....	310, 1082
Mallet Caps .....	1012	Rulers.....	1082
Maloney-Style & Hurst-Style Bougies.....	465	Specialty .....	1084
Maloney Tapered Tungsten-Filled Esophageal Bougies.....	466	<b>Measuring Guidelines and Common Jaw Patterns of Surgical Instruments</b> .....	18
Maltz Rasp .....	511, 977	Mediastinal Blunt-Tipped Dissecting Forceps .....	777
Maltz Rasp Improved.....	977	<b>Mediastinoscopy</b> .....	774
Maltz-Seeburger Retractors.....	901	Clips and Applicators.....	779
Markham-Meyerding Hemilaminectomy Retractors .....	905	Instrumentation.....	775
Marking Rings .....	794	Mediastinoscopes.....	774
Marking Ring-Vein Graft.....	794	Scope Holders .....	778
Martin Cartilage Clamps .....	946	Medicine Cup.....	338
Martin Cartilage Scissors.....	121, 951	Medium Pin Cutter .....	829
Martin Drill .....	850	Meeker Dissecting Forceps.....	783
Martini Bone Curette.....	986	Meeker Hemostatic Dissecting Forceps.....	81
Martin Laryngectomy Tubes - Regular and Extension .....	486	Meltzer Adenoid Punch.....	533
Martin Rectal Hook .....	305	Meniscus Clamp .....	947
Maryland Dissectors .....	1135	Metal Labels .....	370
Masson Bulldog® Needle Holders.....	165	Metzenbaum Scissors .....	123, 258
Masson Needle Holder.....	166, 259	Metzenbaum Scissors, Curved .....	783
		Metzenbaum Scissors, Delicate.....	122
		Meyerding Blades.....	913
		Meyerding Finger Retractors.....	200
		Meyerding Laminectomy Retractors .....	887, 905



Meyhoeffer Currettes.....	1124	Marking Rings.....	794
M.G.H. Vulsellum.....	282	Obturator.....	794
Michel Clip Applying Forceps.....	320	Tourniquet Stylets.....	795
Michel Clip Forceps.....	320	Tunnelers.....	796
Michele Trepheine.....	868	<b>Miscellaneous General.....</b>	<b>307</b>
Michel Skin Clips.....	320	Dermal Instruments.....	312
Micro-Aneurysm Bulldog® Clips and Appliers.....	571	Ligature Carriers.....	314
Micro Clamp Applicator.....	319	Measuring Devices.....	309
Micro Clamp Case.....	321	Probes, Cannulae and Dilators.....	307
Micro Clips and Appliers.....	315	<b>Miscellaneous Orthopedic.....</b>	<b>1091</b>
Temporary Vessel Clips.....	315	Diagnostic Instruments.....	1092
Micro Clip Sterilizing Tray.....	321, 572	Lead Hands.....	1091
Micro Diama-Grip Ring Forceps.....	552	Ring Cutters.....	1092
Micro Dissector.....	1136	Specialty Hand Instruments.....	1093
Micro Friedman Rongeurs.....	1024	Miskimon Cerebellum Retractor.....	905
Micro Grasping Forceps.....	550	Mitchel-Adam Multipurpose Clamp.....	622
Micro Instrument Trays.....	323	Mitchell Aortomy Clamp.....	642
Micro-Laryngeal Forceps.....	425	Mixer Clamps.....	82
Micro-Laryngeal Probes - Ebonized.....	433	Mixer Dissecting Forceps.....	82
Microminiature Alligator Forceps.....	495	Mixer Dissectors.....	1135, 1138
Micro Mosquito Forceps.....	74	Mixer Forceps.....	83, 97
Micro Reill Scissors.....	1113	Mixer Gall Duct Forceps.....	83
Micro Ring Tip Forceps.....	552	Mixer "Pedi" Gall Duct Forceps.....	84
Micro Scissors.....	1148	Mixer Right Angle Forceps.....	252
Micro Spring Scissors.....	1113, 1117	Mixer Thoracic Forceps.....	82
Microsubglottic Instruments.....	408, 432	Mogen Circumcision Clamp.....	269
Micro Surgery Needle Holders.....	176, 683	Moisture Barrier For Co <sub>2</sub> Coupler-Manipulator.....	440
Micro Surgery Technique® Needle Holders.....	179, 680	Moleskin Scissors.....	104
Microsurgical Cases.....	332	Moore Drill and Bit Set.....	850
Micro Tip.....	1141	Mooreland Rongeur.....	1059
Micro Titanium Castroviejo Needle Holders.....	707	Morris Ascending Aorta Clamps.....	643
Micro Titanium Diama-Grip Tying Forceps.....	691	Morse-Andrews Suction Tube.....	248, 765
Micro Titanium Scissors.....	704	Morse Sternal Retractors With Double Blades.....	732
Micro Tying Forceps.....	551, 1106	Morse Towel Clip Tubing Holders.....	26
Micro Vascular Anastomosis Scissors.....	672	Morse Valve Retractor.....	752
Micro Vascular Nerve Hook.....	759	Mosquito Forceps.....	63
Micro Vascular Round Handle Needle Holders.....	175, 683	Mosquito Forceps Serrated.....	64
Micro Vascular Scissors.....	663	<b>Mouth and Throat Instruments.....</b>	<b>521</b>
Micro Vascular Set Of 11 Instruments.....	798	Adenotomes/Tonsectomes.....	521
Microvascular Titanium Ring Handle Needle Holders.....	712	Currettes.....	522
Milan-London Vacuum Tube.....	289	Forceps.....	523
Miller-Senn Retractors.....	207	Laryngeal Mirrors.....	524
Mills Valvulotome.....	772	Miscellaneous.....	533
Mini-Aneurysm Bulldog® Clips and Appliers.....	572	Mouth Gags.....	524
Miniature Eye Scissors.....	1118	Retractors.....	528
Miniature Pediatric Clamps.....	594	Scissors.....	530
Miniature Satinsky Reynolds Clamps.....	593	Snare.....	531
Mini Countersink.....	860	Mouth Gags.....	524
Mini Cruciform Screwdriver Bit.....	873	Mueller Capsule Scissors.....	951
Mini Freidman Fongeurs.....	1025	Mueller Rake Retractor.....	194
Mini Hexagonal Screwdriver.....	871	Multipurpose Retractors.....	229, 748
Mini Hohmann Retractors.....	895	Multipurpose Stainless Steel Trays.....	325
Mini-Lambotte Osteotomes, Straight 5".....	992	Murphy Bone Skid.....	890
Mini Mallet.....	1011	Murphy Rake Retractors.....	193
Mini Osteotomes.....	509, 995	Mycotic Nail Nippers.....	1068
Mini Plate Bending Iron.....	879	Myringotomy Knife.....	502
Mini Plate Bending Pliers.....	844		
Mini Quick Coupling Handle.....	856		
Mini Screw Fixation Set.....	875		
Mini Weck® Micro Vessel Approximator.....	316		
<b>Mirrors.....</b>	<b>524</b>		
Laryngeal Mirrors.....	524		
<b>Miscellaneous CVT.....</b>	<b>793</b>		
Endarterectomy Dissectors.....	793		

## N

<b>N-Compass™ Instrument Management System.....</b>	<b>14</b>
<b>Nail Instruments.....</b>	<b>1068</b>
Forceps.....	1072
Instruments.....	1074



Nippers .....	1068	Novak Biopsy Curette.....	276
Scissors.....	1073	Noyes Ear Forceps.....	496
Splitters.....	1070	Noyes Nasal Alligator Forceps.....	505
Nail Nippers.....	1069	Nucleus Knife .....	1125
Nail Rasp #93.....	972	Nylon Head Mallet Faces .....	1013
Narrow Nose Wire Pulling Forceps .....	835	Nylon Head Mallets .....	1013
Narrow Tip Mallet.....	1011		
<b>Nasal Instruments</b> .....	503		
Elevators .....	503		
Forceps .....	505		
Knives .....	508		
Miscellaneous .....	520		
Osteotomes .....	508		
Raspatories .....	509		
Scissors.....	512		
Sinus Instruments .....	514		
Snare .....	517		
Specula.....	518		
Nasal Snare Wires .....	517		
<b>Needle Holders</b> .....	150		
Bariatric .....	259		
Berry Sternal Technique® Needle Holder.....	183, 684		
Castro-Type Micro Needle Holders .....	175		
CVT-Type Needle Holders.....	169		
Extended Length/Open Bariatric.....	259		
Floor Grade Needle Holders .....	353		
General Needle Holders.....	150		
Intracardiac Technique® Needle Holders .....	173, 677		
Laparoscopic .....	1147		
Ophthalmic .....	1121		
Pilling® Extra Light Technique® Needle Holders .....	172, 676		
Suture Tags.....	184		
Wire Twisters.....	182		
<b>Needle Holders, Titanium</b> .....	707		
Flat Handle Micro Needle Holders .....	708		
Ring Handle Needle Holders.....	709		
Round Handle Micro Needle Holders.....	707		
Needle Nose Locking Pliers.....	843		
Needle Nose Pliers .....	835		
Needles, Urology .....	295		
Neivert-Eve Tonsil Snare.....	531		
Neivert Needle Holder .....	155		
Nelson Lobectomy Scissors.....	129		
Nelson Metzenbaum Scissors.....	258		
Nelson Metzenbaum Super-Cut Scissors .....	258		
Nelson Scissors .....	129		
Nelson Tissue Forceps .....	53, 549		
Nerve Root Retractor .....	884		
Neuro Caliper.....	311, 1083		
Neurofeel Micro Scissors.....	672		
Neuro Sponges .....	360		
Nevins Forceps .....	40		
News Trachea Retractor.....	190, 490		
NextStitch® Valve Suture .....	1164		
Nicholas-Jehle Sterile Multi-Headed Perfusion Catheter .....	761		
Nichols Tubing Holder.....	27		
Nippers .....	1068		
Nolan Needle Holders .....	261		
Non-Insulated Non-Rotating Handle .....	1134		
Non-Insulated Rotating Handle .....	1134		
Non-Perforated Container Bottom .....	368		
Norris Sponge Holding Forceps .....	418, 778		
Norris Tracheostomy Buttons.....	487		
Northbent Stitch Scissors .....	107		
		<b>O</b>	
		<b>OB/GYN</b> .....	262
		Biopsy Punch.....	266
		Circumcision Clamps.....	269
		Curettes .....	275
		Delivery Forceps.....	270
		Forceps and Clamps .....	262
		Laser Instruments .....	288
		Miscellaneous .....	291
		Probes, Sounds and Dilators.....	272
		Retractors .....	286
		Scissors.....	271
		Specula.....	283
		Tenaculums and Vulsellums.....	278
		Obturator.....	794
		Ochsner-Favaloro Improved Retractor Set	
		With Poly Clamps .....	723
		Ochsner-Favaloro Retractor Parts .....	724
		Ochsner-Favaloro Retractor Set.....	724
		Ochsner Forceps (Kocher) .....	69
		Ochsner Ribbon Retractors.....	214
		O'Conner Skin Hook .....	188
		O'Connor Hook .....	1123
		Offset Metzenbaum Scissors .....	670
		Oldberg IVD Rongeur.....	1064
		Olivekrona Double End Dissectors .....	793
		Ollier Rake Retractor.....	195, 887
		Olsen Hegar Needle Holder and Scissors .....	158
		Olsen-Hegar Needle Holders .....	159
		One-Handed Rod Bender .....	877
		O'Neill Double Curved Clamp .....	644
		<b>Operating Scissors</b> .....	114
		Operating Scissors, B/B .....	113
		Operating Scissors, S/B .....	113
		Operating Scissors, S/S.....	113
		Operating Scissors, TC.....	114
		Ophthalmic Instruments .....	1100
		O'Reilly Esophageal.....	1153
		Original Henly Popliteal Retractor.....	226, 750
		Orthopedic Mallets.....	1016
		<b>Orthopedic Retractors</b> .....	882
		Hand-Held Orthopedic Retractors.....	882
		Hohmann Retractors .....	895
		Self-Retaining Orthopedic Retractors .....	899
		Shoulder and Knee Retractors.....	891
		O'Shaughnessy Titanium Clamping Forceps .....	701
		Ossoff Adult Subglottoscopes.....	407
		Ossoff Double-Action Posterior Commissure	
		Laryngoscope .....	405
		Ossoff-Karlan-Dedo Laser Micro-Laryngoscopes .....	407
		Ossoff-Karlan Grasping Forceps - Ebonized .....	407
		Ossoff-Karlan-Jako Laser Micro-Laryngoscope.....	407
		Ossoff-Karlan Micro Suction Tube - Ebonized .....	407
		Ossoff-Karlan Posterior Commissure Micro-Laryngoscope.....	407
		Ossoff-Karlan Vocal Cord Roller - Ebonized.....	407



Ossoff-Pilling® Micro-Laryngoscope.....	398	Perforated Silicone Mat.....	369
Ossoff-Pilling® Micro-Laryngoscope (Laser Finish) .....	403	Perforated Tray With Feet.....	369
Ossoff Micro Suction Tube Ebonized.....	289	Periosteal Elevator.....	964
Osteotome Case.....	332	Perpendicular Nerve Retractor.....	885
<b>Osteotomes</b> .....	992	Perthes Bone Awl .....	944
Cobb.....	999	Phaneuf Uterine Artery Forceps.....	264
Hibbs.....	998	Phenolic Handle Mallets.....	1018
Hoke.....	995	P.I. Buried K-Wire Set.....	815
Interchangeable Osteotome, Chisel and Gouge Set.....	1000	Piffard Currettes .....	313
Lambotte.....	992	<b>Pilling® and KMedic® Surgical Instruments</b> .....	7
Nasal .....	508	Pilling®-Wolvek Sternal Approximation and Fixation	
Sheehan .....	996	System.....	743
Silver .....	996	Pillsbury-Jesberg Esophagoscopes .....	447
Smartrack .....	1001	Pin Cutters .....	827
Smith Peterson .....	999	Pin Mats.....	337
Specialty .....	995	Pin Pulling Pliers .....	838
Stille .....	997	P.I. Plug Cutter.....	868
US Army.....	997	<b>Policies and Procedures</b> .....	11
Osteotome, Smartrack.....	1086	Plain Splinter Forceps .....	32
O'Sullivan-O'Connor Abdominal Retractors.....	234	Plaster Cast Instruments.....	1078
Oval Spoon Forceps.....	497	Plastic Scissors.....	139
<b>P</b>			
Paddle Babcock Grasper.....	1145	Plasti Stats® Adson Forceps.....	74
Parallel Drill Guide and Drill Sleeve.....	864	Plasti Stats® Collier Forceps .....	74
Parallel Pliers.....	841	Plasti Stats® Crile Hemostats.....	75
Parallel Pliers With Cutter.....	842	Plasti Stats® Kocher Forceps .....	75
Parham-Martin Bone Clamp .....	922	Plasti Stats® Mosquito Forceps.....	75
Parker-Mott Retractors .....	205	Plate and Bone Holding Forceps.....	922
Parker Retractors .....	205	Plate Bending Iron.....	880
Par Needle Holders .....	155	Plate Bending Pliers .....	845
Par Scissors .....	138	Plate Bending Press .....	846
Parsonnet Epicardial Retractor.....	720	Plate Cutting Forceps.....	831
Pass Thru Brackets.....	336	Plate Holding Clips .....	881
Patella Bone Holding Forceps.....	923	Platform Tying Forceps.....	1107
Pate Tray Posts .....	327	Platypus Nail Removing Forceps.....	1073
Patient Size Listing.....	388	<b>Pliers</b> .....	835
Patterson Elongated Cup Biting Forceps .....	418, 777	Locking Pliers.....	843
Patterson Trocar and Cannula .....	308	Plate Bending Pliers .....	844
Pean Clamps .....	67	Socket Wrenches .....	847
Peanut Sponges.....	362	Plug Cutter.....	868
Peapod IVD Rongeur.....	1060	Pointed Drill Guide .....	866
Peck-Joseph Skin Hook .....	188	Polk Finger Goniometer .....	310, 1084
Peck Mallet .....	1014	Polk Placenta Forceps.....	263
Peck-Vienna Nasal Speculum .....	519	Polokoff Bone Rasps.....	977
Pederson Vaginal Specula.....	284	Polysulfone Sterilization Trays.....	324
Pediatric Bronchoscopic Instruments.....	460	Pool Abdominal Suction Tubes.....	244
Pediatric Cast Breaker .....	1078	Poole Suction Tubes.....	249
Pediatric Mixer Dissecting Forceps .....	83	Ports, Laparoscopic Access .....	1167
Pediatric Poole Suction Tube.....	244	Potts Micro Titanium Scissors.....	706
Pediatric Titanium Sternal Spreader .....	713	Potts Scissors .....	663
Pediatric Universal Clamps.....	751	Potts Smith Dissecting Scissors .....	670
Peers Towel Forceps .....	31	Potts-Smith Dressing Forceps .....	40
Pelvic Ball Spike.....	1098	Potts Smith Forceps .....	249
Pelvic Reduction Forceps.....	937	Potts Smith Scissors.....	664
Pelvic Retractor .....	890	Potts-Smith Technique® Dressing Forceps .....	40
Penfield Elevators.....	956	Potts-Smith Tissue Forceps .....	54
Pennington Forceps .....	99	Potts Smith Vascular Scissors.....	665
Pennington Grasping Forceps .....	781	Potts Tenotomy Scissors .....	130, 258, 670
Percy Amputation Shield.....	1077	Pratt Crypt Hook.....	306
Perforated Container Lid.....	368	Pratt Rectal Specula .....	204
Perforated Mayo Trays .....	327	Pratt "T" Forceps .....	
		Pratt Uterine Dilators .....	
		Premie Retractor .....	
		Premium Diamond-Edge Aortic Punch, Full Length....	
		Premium Diamond-Edge Aortic Punch, Mid-Length....	





Presbyterian Hospital Tubing Clamp .....	27	Retractor Fiber Optic "Light Beam" .....	242
Preston Ligamentum Flavum Forceps (Meniscus) .....	948	<b>Retractors</b> .....	720
Probe and Packer.....	1094	Bariatric .....	261
Probe/Elevators .....	423	Epicardial.....	720
<b>Probes, Cannulae and Dilators</b> .....	307	Extended Length/Open Bariatric.....	261
OB/GYN Probes, Sounds and Dilators.....	272	Hand-Held.....	744
Probes, Knot Pushers (Laparoscopic) .....	1151	Henly-Type Retractors.....	748
Probes, Ophthalmic .....	1126	IMA .....	720
Probes with Proximal Eye .....	308	Laparoscopic .....	1152
Providence Hospital Forceps .....	70	Mouth and Throat Retractors .....	528
Providence Hospital Hemostats.....	71	OB/GYN Retractors .....	286
Pryor-Pean Retractor.....	287	Pilling® Sternal Retractor and Rib Spreader Dimensions .	741
<b>Punches</b> .....	266	Rectal Retractors and Specula.....	301
Aortic Punches .....	762	Sternal Closure .....	743
Biopsy Punch.....	266	Sternal Retractors/Rib Spreaders.....	727
Reusable Punches .....	763	Titanium Instruments.....	713
Spinal Rongeur and Punch.....	1045	Urology Retractors .....	297
Putti Bone Rasp .....	973	Valve Retractors .....	751
<b>R</b>		<b>Retractors, Hand-Held</b> .....	185
Ragnell-Linde Retractor .....	885	Abdominal-Type Retractors .....	207
Ragnell Retractor.....	205	Double Ended Retractors .....	201
Ragnell Scissors .....	140	Hook and Rake Retractors.....	190
Ragnell Scissors, Delicate.....	140	Ribbon-Type Malleable Retractors .....	214
Rail Clamps .....	339, 725	Single Ended Retractors .....	196
Ralks Drill.....	851	Skin Hooks.....	185
Randall Kidney Stone Grasping Forceps .....	292	Specialty Retractors .....	215
Randall Suction Biopsy Curette .....	277	<b>Retractors, Orthopedic</b> .....	882
Raney Clip Applying Forceps.....	367	Hand-Held Orthopedic Retractors.....	882
Raney Gigli Saw Guide .....	1076	Hohmann Retractors .....	895
Raney Nylon Clips.....	367	Self-Retaining Orthopedic Retractors .....	899
Rankin Forceps.....	71	Shoulder and Knee Retractors.....	891
Rankin-Kelly Hemostat Forceps .....	71	Vickers Finger.....	899
Raspatories .....	509	<b>Retractors, Self-Retaining</b> .....	216
Raspatories and Periosteal Elevators .....	716	Abdominal/Balfour-Type Retractors .....	230
<b>Rasps</b> .....	972	Thyroid Retractors .....	237
Bone Rasp .....	974	Weitlaner, Gelpi and Henly-Type Retractors .....	218
Bone Rasp #64.....	972	Wire and Alm-Type Retractors.....	216
Ratchet Lock.....	655	<b>Retractors, Table-Mounted</b> .....	238
Ratcheted Grasper.....	1142	Circuitract Retractor System .....	238
Ratcheted Non-Rotating Handle.....	1134	Miscellaneous Retractors.....	242
Ratcheted Rotating Handle .....	1134	Wishbone Retractor System.....	240
Ray Pituitary Curettes .....	988	Revue-Garcia Allis Curved Clamps .....	557
<b>Rectal</b> .....	298	Revue-Garcia Valve Leaflet Retractor .....	752
Forceps and Clamps .....	298	Revue-Garcia Valve Mirror.....	759
Miscellaneous .....	305	Revue-Garcia Valve Scissors.....	671
Retractors and Specula .....	301	Rhinoplasty Flat Tip Scissors .....	513
Rectal Biopsy Forceps.....	299	Rhoton Ball-Tipped Dissectors .....	953
Reill Bone Reduction Forceps.....	932	Rhoton Elevators .....	953
Reiner Plaster Knife.....	1080	Rhoton Micro Curettes .....	954
Renal Artery Titanium Vascular Clamp .....	702	Rhoton Micro Dissection Hooks .....	954
Renal Perfusion Clamps .....	570	Rhoton Needle Sharp .....	954
Replacement Clips .....	415	Rhoton Round Dissectors.....	955
Replacement Guide Silicone Caps .....	443	Rhoton Spatula Dissectors.....	955
Replacement Luer-Lok Hub Adapter .....	415	<b>Rib Instruments</b> .....	714
Replacement Stylet For Rumel Tourniquet.....	795	Approximators.....	716
Replacement Telescope Guide Silicone Caps.....	442	Raspatories and Periosteal Elevators .....	716
Reprologie Pediatric Aorta Cross Clamp .....	589	Rib Shears / Sternum Cutters .....	718
Reprologie Infant Sternal Retractor .....	730	Rongeurs.....	714
Reprocussion Free Mallet .....	1018	Ribbon Retractors .....	214
Reprocussion Free Mallet Cap .....	1018	Richardson Appendectomy Retractor .....	21
Retraction Grasper .....	1142	Richardson-Eastman Retractors .....	21
		Richardson Retractors.....	21
		Richter Heath Clip Forceps .....	32
		Rienhoff Retractors .....	73





Scopes.....	534	Single Slot Screwdriver.....	872
Scoville Blades.....	914	Singley Dressing Forceps.....	250
Scoville Curettes.....	984	Singley Tissue Forceps.....	53, 550
Scoville-Haverfield Retractor Blade.....	913	Sinsky Micro Lens Hooks.....	1122
Scoville Hemilaminectomy Retractor Body.....	912	Sinus Instruments.....	514
Scoville Nerve Root Retractors.....	885	Sinus Seeker.....	516
Scope Holder/Mediastinoscopy.....	774	Sisson Nerve Hook.....	190, 759
Screw Depth Gauges.....	874	Sistrunk Fine Scissors.....	120
<b>Screw Drivers.....</b>	<b>869</b>	Sistrunk Heavy Scissors.....	120
Cruciform Head.....	873	Skillman Mosquito Forceps.....	64
Depth Gauge.....	874	Skin Hooks.....	185
Hex Head.....	869	Skin Self-Retaining Retractors.....	217
Screw Driver Sets.....	875	Skin Staplers.....	1169
Screw Holding Forceps.....	876	Slender Pederson Speculum.....	284
Screwdriver Sleeves.....	870	Slide-Lock Handle.....	1134
Screw Removal Forceps.....	838	Slip Joint Pliers.....	840
T-Handle.....	874	Slotted "U" Brackets.....	335
Scrub Files.....	344	Sluder-Jansen Mouth Gag.....	528
Sedillot Periosteal Elevator.....	963	Small Countersinks.....	860
Self-Retaining Screw Holding Forceps.....	876	Small Pin Cutter.....	829
Selman Tissue Forceps.....	55	Small Plate Bending Irons.....	879
Selverstone Ivd Rongeur.....	1060	Small Plate Bending Pliers.....	846
Semb Bone Holding Forceps.....	923	Small Quick Coupling Handle.....	856
Semb Dissecting Forceps.....	554	Small Quick Coupling T-Handle.....	856
Semb Ligature Forceps.....	554	Smartracks.....	1085
Semb Retractor.....	201	Smartrack Lambotte For 9" Osteotomes.....	1088
Semken Dressing Forceps.....	41	Smillie Knee Retractors.....	894
Semkin Tissue Forceps.....	52	Smillie Knives.....	950
Senning Featherweight Bulldog® Clamps.....	565	Smith-Petersen Laminectomy Rongeur.....	1037
Senn-Kanavel Delicate Retractor.....	206	Smith Peterson Gouges.....	1006
Senn Retractors.....	206	Smith Peterson Osteotome.....	999
Serrefines Cross-Action Clamps.....	73	Smith Peterson Smartrack.....	1089
Shambaugh Adenoid Curettes.....	522	Smith Rectal Retractor.....	301
Shambaugh Reverse Curve Adenotomes.....	521	Smithwick Dissector and Hook.....	883
Shanz Pins.....	810	Smithwick Hook and Dissector.....	953
Sharp Hook.....	942	Snake Tooth Grasper.....	1144
Shea Vein Graft Scissors.....	140	<b>Snares.....</b>	<b>531</b>
<b>Shears.....</b>	<b>718</b>	Mouth and Throat Snares.....	531
Rib Shears/Sternum Cutters.....	718	Nasal Snares.....	517
Sheehan Osteotomes.....	996	Snitman Endaural Retractor.....	902
Sheppard Incision Irrigation Cannula.....	1128	Snook Hook.....	883
Shikani-French Speaking Valve and Inner Tube		Socket Wrenches.....	847
Combination.....	476	Solid Copper Head Mallet.....	1011
Shikani-French Tracheostomy Speaking Valve.....	477	Solvay Spay Hook.....	191
Short 1 mm Pediatric Clamps.....	576	Somer Uterine Elevating Forceps.....	263
Short Jaw Nail Splitters.....	1072	Sonnenschein Child Nasal Speculum.....	518
Shortbent Stitch Scissors.....	108	Sounds, OB/GYN.....	272
Shoulder Penetrating Awl.....	944	Sounds, Urology.....	295
Shoulder Penetrating Gouge.....	1006	Spatula and Packer.....	1094
Shoulder Percussion Awls.....	945	Specialty Sponges.....	357
Side Biter Forceps.....	515	<b>Specialty Trays.....</b>	<b>1090</b>
Side Cutter.....	824	Flat Packs.....	1090
Side Pin Cutter.....	829	<b>Specula.....</b>	<b>1125</b>
Silicone Mats.....	327	Ear Specula.....	499
Silver Osteotomes.....	996	Esophagoscope Specula.....	450
Simpson-Luikart Obstetrical Forceps.....	271	Nasal Specula.....	518
Simpson Obstetrical Forceps.....	271	OB/GYN Specula.....	283
Simpson Uterine Sound.....	273	Ophthalmic.....	1125
Sims Rectal Speculum.....	304	Rectal.....	301
Sims Scissors.....	119	Spencer Coronary Technique® Needle Holder.....	179, 68
Sims Uterine Curettes.....	277	Spencer Scissors.....	10
Sims Uterine Sounds.....	273	Spencer Stitch Scissors.....	10
Sims Vaginal Retractors.....	287	Spinal Implant Removal Set.....	106
Single One-Piece Fiber Optic Light Carriers/Cables.....	401	Splinter Forceps.....	10





Splitters, Nail .....	1070	Bronchoscopes and Esophagoscopes .....	452
Sponge Bowls .....	338	General.....	243
Sponges .....	357	Specialty .....	245
Spoon Grasper .....	1139	Suctions .....	424
Spring-Loaded Non-Rotating Handle .....	1134	Super-Cut (Baby) Metzenbaum Scissors.....	146
Spurling Ivd Rongeurs.....	1062	Super-Cut Hi-Level Bandage Scissors .....	144
Spurling-Kerrison Punches.....	1054	Super-Cut Iris Scissors.....	147
Squeeze Handle.....	1134	Super-Cut Jamison Scissors.....	146
"S" Retractor .....	201	Super-Cut Lister Bandage Scissors .....	144
SS Riser Bracket.....	335	Super-Cut Lister Bandage Scissors with Large Finger Ring .....	144
Stagbeetle Bone Reduction Forceps .....	931	Super-Cut Mayo Scissors .....	145
Stainless Steel Wire Cutting Forceps .....	823	Super-Cut Metzenbaum Scissors.....	146
Stamey Needles.....	296	Super-Cut Operating Scissors.....	145
Standard Plate Bending Iron.....	879	Supercut Scissors, Metzenbaum .....	1148
Standard Tip .....	1141	Supercut Scissors, Peritoneal .....	1148
Staude-Moore Tenaculum .....	280	Super-Cut Stevens Scissors.....	147
Staude Tenaculum .....	280	Surg-I-Band® Tape.....	348
Steinman Pin Chuck .....	813	Surgical Cases and Trays .....	333
Sterilization and Storage Trays .....	410	Surgical Utility Cases .....	333
Sterilization Case and Tray Solutions .....	328	Suture, CVT .....	1164
Sterilization Containers.....	368	Suture Organizer .....	1164
Sterilization Trays.....	325, 1149	Suture Passers.....	849
Sternal Approximator .....	743	Suture Removal Scissors.....	110
Sternal Locking Plates.....	743	Suture Rings, Valve .....	756
Stevens Tenotomy.....	141	Suture Tags.....	184
Stevens Tenotomy, Delicate .....	141	Swan Neck Gouge .....	1007
Stewart Rectal Hook.....	306	Sweet Modified Sternal Punch.....	744
Stille-Horsley Bone Cutting Forceps .....	1022	Synovectomy Rongeurs.....	1023
Stille-Liston Bone Cutting Forceps.....	1021	Sypert Rongeur.....	1044
Stille-Luer Duckbill Rongeur.....	715		
Stille-Luer Echlin Duckbill Rongeurs.....	1042		
Stille-Luer Rongeurs.....	1043		
Stille Osteotomes.....	997		
Stille Pattern Drill, Bits and Burrs .....	851		
Stille Pattern Rib Shears .....	719		
Stille Plaster Shears.....	1078		
Stille-Sherman Drill .....	852		
Stille-Type Chisels.....	1004		
Stille-Type Gouges.....	1006		
Stitch Scissors .....	1120		
Stone Intestinal Clamps.....	100		
Stoney Deep Aorta Clamps .....	646		
Stoney Spleno-Renal Shunt Clamp .....	611		
Storey Hemostatic Forceps.....	86		
Strabismus Scissors .....	142		
Straight Debakey® Grasping Forceps .....	782		
Straight Masher Grasping Forceps.....	781		
Straight Single Action Needle Holder.....	783		
Stratte Needle Holders.....	169		
Strelinger Right Angle Clamp .....	100		
Strippers, Tendon .....	952		
Strong Aorta Clamps .....	642		
Strong Grasper .....	1144		
Strong Grasping Forceps .....	1137		
Strong Suction Irrigator .....	419		
Strong T-Bar Retractor System.....	726		
Strong T-Bar Unilateral System Components .....	726		
Strully Probed Tip Scissors.....	131, 671		
Stylet For Rumel Tourniquet, Child Size.....	795		
Stylet For Weck® Style Rumel Tourniquet.....	795		
Subacromion Spreaders .....	892		
<b>Subglottiscopes</b> .....	406		
Laser Subglottiscopes.....	406		
<b>Suction Tubes</b> .....	765		
		<b>T</b>	
		Table Clamp .....	413
		Table Top Rod Cutter.....	834
		Takahashi Forceps.....	506
		Tamps, Bone .....	1009
		Tapered (Dolphin Nose) Dissection Forceps.....	1136
		Tapered Maryland Dissectors .....	1135
		Tap Sleeves .....	865
		Taut® Cholangiogram Catheter .....	1165
		Taut® Intraducer® .....	1165
		Taut® System One™ Common Bile Duct Exploration Kit.....	1166
		Taylor Laminectomy Blades .....	914
		Taylor Percussion Hammer .....	1093
		Taylor Retractors .....	888
		Taylor Spinal Blades .....	915
		Taylor Spinal Retractors .....	888
		Teale Uterine Vulsellum .....	282
		Teeth Guards.....	389
		Telescope Guides.....	442
		Telescope Locking Device.....	443
		Telescopes .....	1152
		Telescope Compatibility chart .....	444
		Telescopes with Fiber Optic Illumination .....	443
		Telescopic Hand Drill Set.....	853
		Temporary Occlusion Clips .....	315, 568
		Tenaculum Grasper .....	1111
		Tenaculums and Vulsellums .....	
		Tennant Tying Forceps .....	
		Tension Device.....	
		Tension Device Articulated .....	
		Tevdek®/Polydek® Braided Polyester Suture.....	



Tew Tying Forceps.....	551, 1107
The Bush Retrograde Valvulotome .....	773
The Pilling® Vascular Access Set .....	800
Thin Vascular and Coronary Technique® Needle Holders .....	173
Thomas-Gaylor Biopsy Punch.....	268
Thomas-Gaylor Cervical Biopsy Forceps .....	268
Thompson Carotid Closure Clamp.....	609
Thompson Clamp.....	608
Thompson Thoracic Instrument Holder .....	339
Thoms-Allis Tissue and Traction Forceps .....	89
Thoms-Allis Vulsellum Forceps.....	290
Thoracic Artery Forceps .....	56
Thoracolumbar Spinal Implant Removal Set .....	1066
<b>Thoracoscopy</b> .....	781
Kaiser-Pilling™ Thoracoscopic Forceps .....	788
Landreneau Design .....	780
Video Assisted.....	781
Thorek Scissors .....	121
Three Finger Fan.....	1152
Three-Fluted Drill Bits .....	859
Throat Snare Wires.....	532
Thru-Cut Forceps .....	514
Thumb Bayonet Dressing Forceps.....	39
Thumb Dressing Forceps .....	34
Thumb Forceps.....	34
Thumb Tissue Forceps .....	41, 249
Tieck Infant Nasal Speculum .....	518
Tischler Biopsy Punches .....	268
Tissue Forceps.....	42, 1105
Tissue Nippers.....	1070
Tissue Retractor .....	902
<b>Titanium Instruments: Forceps and Clamps</b> .....	686
Bulldog® Clamps.....	703
Hemostatic Forceps .....	692
Micro Forceps.....	690
Pediatric Vascular Clamps.....	693
Tissue and Dressing Forceps.....	686
Vascular Clamps .....	696
<b>Titanium Instruments: Needle Holders</b> .....	707
Flat Handle Micro Needle Holders .....	708
Ring Handle Needle Holders.....	709
Round Handle Micro Needle Holders.....	707
Titanium Instruments: Retractors .....	713
<b>Titanium Instruments: Scissors</b> .....	704
Micro Scissors .....	704
Titanium Retrieval Basket .....	1166
TL Spinal Implant Removal System .....	1066
Tobey Ear Forceps.....	496
Tobey Laryngoscope Holder .....	413, 778
Tonsil Clamp .....	253
Tonsil Forceps.....	253
Tonsil Sponges.....	365
Tourniquet Stylets .....	795
Townley Femur Caliper .....	312, 1083
Trachea Hook.....	191
<b>Tracheostomy Tubes</b> .....	471
Air-Lon® Design .....	484
Cleaning Brushes.....	492
Decannulation Stoppers.....	488
Holinger Design.....	482
Jackson Improved Design .....	471
Jackson Improved Design – Shikani Valve Compatible.....	475
Jackson Original Design.....	478
Laryngectomy Style Tubes.....	485
Luer Design .....	483
Mayo Design .....	482
Miscellaneous .....	490
Trach Buttons .....	487
Tracheal Dilators.....	489
Tracheostomy Tubes .....	489
Tucker Design .....	481
<b>Trademarks</b> .....	12
Transplant Donor Sternal Retractors .....	740
Transplant Recovery Balfour Retractors.....	232
Tray Handle.....	325
Trays.....	325, 328, 1149
Trephines .....	868
Troutman Alpha-Chymotrypsin Cannula .....	1129
Troutman-Barraquer Tissue Forceps.....	1105
Tubbs Valve Dilator.....	760
Tucker Bead Grasping Forceps.....	458
Tucker Lumen Finders.....	467
Tucker Mid-Lighted Side Slide Laryngoscopes.....	389
Tucker Trachea Tubes and Valves .....	481
Tuffier Retractor .....	736
Tungsten Carbide .....	1147
Tungsten Carbide, Ratcheted.....	1147
Tuning Forks.....	502
Tunnelers .....	796
Turnbull Nail Nippers .....	1068
Tuttle Thoracic Tissue Forceps.....	53, 550
Two-Level Lap Chole Cases .....	331
Tyding Tonsil Snare .....	532
Tygon Tubing With Luer-Lock Connector .....	414
Tyrell Hooks.....	189
<b>U</b>	
U-Handle.....	1134
Ulnar Radial Approximator .....	317
Ulrich Self-Retaining Bone Holding Forceps .....	928
Ultimate-Cut Cooley Scissors .....	145
Ultimate Cut Mayo Scissors .....	148
Ultimate Cut Metzenbaum Scissors.....	148
Ultimate Cut Potts Scissors.....	148
Ultimate Cut Stevens Tenotomy Scissors .....	149
Umbilical Scissors .....	272
Universal Brackets.....	335
Universal Chuck With T-Handle.....	813
Universal Drill.....	852
Universal Drill Guide.....	863
Universal Eye Shield.....	1131
Universal Joint For Wexler Retractors.....	235
Universal Rod Bender .....	877
Universal Shears.....	105
Unna Comdone Extractor .....	314
<b>Urology</b> .....	292
Catheter Guides.....	297
Dilators, Sounds and Needles.....	295
Forceps and Clamps .....	292
Retractors .....	297
Urschel First Rib Rongeur.....	71
Urschel-Leksell Rongeur.....	71
U.S. Army (Army-Navy) Retractors .....	20
U.S. Army Pattern Gouges.....	100
U.S. Army Pattern Osteotomes.....	95

## U



Utility Scissors.....105

## V

<b>Valve Instruments</b> .....	751
Aortic Valve Rongeurs.....	757
Coronary Perfusion Catheters .....	761
Suture Rings.....	756
Valve Dilators.....	760
Valve Hooks.....	758
Valve Retractors .....	751
Valve Sternal Blade Assembly.....	722
<b>Valvulotomes</b> .....	772
Antegrade Cut.....	772
Bush.....	773
<i>In Situ</i> .....	772
Mills-Type.....	772
Valvulotome Antegrade Cut.....	772
Van Beek Nerve Approximators.....	318
Van Buren Catheter Guide .....	297
Van Buren Sequestrum Forceps.....	924
Van Buren Urethral Dilators.....	296
Vanderbilt Vessel Forceps.....	73
Vanguard Splinter Liberator .....	33
Vannas Capsulotomy Scissors .....	1114
Vannas Scissors.....	1114
<b>Vascular Clamps</b> .....	573
Aortic Aneurysm Clamps .....	648
Aortic Compressor .....	655
Aortic Vascular Clamps .....	629
Carotid Clamps .....	604
Carotid Clamps, 1 mm Jaw.....	607
Carotid Clamps, 1.5 mm Jaw.....	609
Cooley Vascular Clamps.....	622
Femoral-Popliteal Clamps.....	612
Pediatric Clamps, 1 mm Jaw .....	575
Pediatric Clamps, 1.5 mm Jaw .....	577
Pediatric Clamps, 2 mm Jaw .....	589
Pediatric Clamps, Cooley-Type Jaw .....	595
Peripheral Vascular Clamps .....	613
Renal Clamps .....	610
Ring Handled Bulldog® Clamps .....	602
Vascular Debakey® Bayonet Tissue Forceps .....	49, 546
<b>Vascular Dilators</b> .....	768
Amato Design .....	768
Cooley Design.....	768
DeBakey® Design.....	769
Garrett Design.....	770
Hiebert Design.....	771
Vasectomy Clamp.....	294
Vasectomy Forceps .....	294
Vasovasostomy Approximator .....	318
Vebrugge Self-Centering Bone Holding Forceps.....	930
Venous Valve Scissors.....	673
Venturi Adapters For Bronchoscopes and Laryngoscopes ..	414
Venturi Ventilating Needles.....	415
Verbruegge Bone Holding Forceps .....	930
Vernon Wire Scissors.....	112
Verres Needles .....	1151
Vertebral Body Distractors .....	909
Vertebra Spreader (Cloward).....	909
Verucca Curette Excavator .....	1094
Vickers Easidriver.....	812

Vickers Finger Retractor.....	899
Vickers Low Profile Hand Retractor .....	900
Vickers Low Profile Small Wound Retractor .....	900
Vickers Universal Retractor .....	900
<b>Video Assisted Thoracoscopy</b> .....	781
Kaiser-Pilling™ Design .....	786
Landreneau Design .....	780
Retractors .....	780
Video Laryngoscope Systems.....	409
Vienna Nasal Speculums.....	519
Virtus Splinter Forceps .....	33
Visistat® Skin Stapler, Regular .....	1167
Visistat® Skin Stapler, Wide .....	1167
Visistat® Rotating Head Stapler, Wide .....	1167
Vogen Sesamoid Clamp.....	941
Volkman Bone Hooks .....	942
Volkman Curettes .....	986
Volkman Pocket Retractors.....	193
Volkman Rake Retractors.....	194
Volkman Retractors.....	194
Von Graefe Strabismus Hooks .....	1123
Vorse Tubing Occluding Clamps.....	28
Vorse Tubing Occluding Clamps With Safety Guard.....	28
V-Silicone Retainers .....	337
Vulsellums and Tenaculums.....	278

## W

Wachenfeldt Clip Applying and Removing Forceps.....	321
Wallace Caesarean Forceps .....	263
Walton Cartilage Clamp .....	946
Walton Cast Spreader .....	1080
Wangensteen Needle Holder .....	174
Wartenberg Neurological Pin Wheel.....	1093
Webster Bulldog® Needle Holder .....	157
Webster Needle Holders .....	156
Webster Skin Graft Knife Handle.....	23
Weck® Biceps Bayonet Forceps .....	1156
Weck® Biceps Cerullo Bayonet Forceps .....	1156
Weck® Biceps Forceps Cords.....	1156
Weck® Biceps Jewelers Forceps .....	1156
Weck® Bipolar Adson Forceps .....	1157
Weck® Bipolar Cushing Bayonet Forceps.....	1157
Weck® Bipolar Cushing Forceps .....	1157
Weck® Bipolar Forceps Cords.....	1158
Weck® Bipolar Iris Forceps .....	1158
Weck® Bipolar Jeweler's Forceps .....	1158
Weck® Bipolar Scoville-Greenwood Bayonet Forceps.....	1157
Weck® Bipolar Semkin Forceps .....	1158
Weck® Daniels Blades.....	521
Weck® Daniels Tonsillectome.....	522
Weck® Disposable Electrodes.....	1159
Weck® Disposable Ima/Ent Electrodes.....	1159
Weck EFX™ Endo Fascial Closure System.....	1167
Weck® Instrument Cleaner.....	344
Weck-Kleen™.....	347
<b>Weck® Ligation Solutions</b> .....	373
Weck® Hem-o-lok® Polymer Locking Ligation System™ .....	374
Weck® Horizon™ Metal Ligation System.....	
Weck® Liquid Detergent.....	
Weck-Lube™.....	
Weck® Micro Vessel Approximators.....	
Weck® Needle Electrode .....	



Weck®-Rack Retainer Clips .....	342	W.M. Lemmon Technique® Needle Holders.....	174, 678
Weck®-Racks.....	342	Wolff (Boehler) Cast Breakers .....	1079
Weck®-Rack Security Rods .....	343	Wood Bulldog® Clamps .....	566
Weck®-Rack Separator Clips.....	343	Woodson Dural Separator and Packer.....	953
Wec-Kreem™ .....	347	Woodson Elevator and Spatula .....	953
Weck® Round Loop Electrodes .....	1160	Wrench.....	847
Weck® Skin Staplers.....	1167	Wrist Tendon Approximator.....	1097
<b>Weck® Specialty Products</b> .....	367	Wullstein-Weitlaner Retractors.....	219
Pin Cutters .....	827	Wutzler Scissors.....	143
Rod Cutters.....	833	Wylie Abdominal Aorta Clamp.....	654
Wire and Pin Drivers and Benders.....	816	Wylie Calcified Arterial Punch.....	763
Wire Guides and Traction Bows.....	848	Wylie Carotid Closure Clamp .....	605
Wire Twisters and Wire/Pin/Rod Cutters .....	816	Wylie Carotid Dissecting Clamp .....	605
Weck Vista® Bladeless Laparoscopic Access Ports .....	1167	Wylie External Carotid Clamp.....	606
Weck® Wipe .....	346	Wylie Hypogastric Clamp.....	606
Wecprep Blades.....	24	Wylie Internal Carotid Clamp.....	606
Wec-Wash™ .....	346	Wylie "J" Aortic Clamps .....	647
Weitlaner Retractors .....	218	Wylie Lumbar Bulldog® Clamp.....	566
Wertheim-Cullen Pedicle Clamp.....	266	Wylie Renal Vein Retractors .....	213, 747
Westcott Micro-Tenotomy Scissors .....	1115	Wylie Splanchnic Retractor.....	213
Westcott Stitch Scissors.....	1115	Wylie Uterine Tenaculum .....	280
Westcott Tenotomy Scissors .....	1115		
Westphal Dissecting Forceps.....	86		
Wexler Bantam Retractor.....	234		
Wexler Deaver Blade .....	235		
Wexler Deep Spreader .....	236		
Wexler Expandable Blade .....	236		
Wexler Standard Octagon Frame.....	235		
Wheeler Technique® Plaque and Vessel Forceps.....	54, 549		
White Tonsil Forceps .....	524		
Wieder Tongue Depressor .....	529		
Wiener Antrum Rasp.....	511		
Wiener Skin Hooks .....	189		
Wilcox Pediatric Cardiac Retractor .....	728		
Wilde (Blakesley) Nasal Forceps.....	506		
Wilde Ear Forceps .....	498		
Wilde IVD Rongeurs.....	1061		
Wilder Lacrimal Dilator .....	1127		
Willauer-Allis Tissue Forceps.....	90, 558		
Willauer-Deaver Retractors.....	209		
Willauer Forceps.....	87		
Williams Lacrimal Probes.....	307, 1126		
Williams Splinter Forceps .....	33		
Williger Bone Curette.....	986		
Wiltse-Gelpi Retractor .....	226, 907		
Window Plug.....	441		
Wire and Pin Bender .....	815		
Wire and Pin Tractor (Boehler) .....	848		
Wire Bending Pliers.....	839		
Wire Cutters.....	823		
Wire Cutting Scissors.....	112		
Wire Forceps.....	183		
Wire Passers (Cannulated).....	849		
Wire Pulling Forceps.....	818		
Wire Scissors.....	111		
<b>Wire Twisters</b> .....	816		
Needle Holder/Wire Twisters .....	182		
Wire Twisting Forceps.....	685, 817		
Wire and Pin Drivers and Benders.....	811, 816		
Wire and Pins/Shanz Pins .....	810		
Wirthlin Spleno-Renal Shunt Clamp .....	611		
Wishbone Lechner-Harrington Liver Blade.....	242		
Wittner Biopsy Forceps.....	269		
W.M. Lemmon Extra Deep Deaver Retractors.....	209		

## Y

Yankauer Suction Tubes.....	244, 249
Yankauer Suction Tube With Switch Valve.....	245
Yankauer Tonsil Scissors.....	530
Yasargil Vascular Scissors.....	666
You-Potts Vascular Scissors.....	666
Yu Holtgreve Malleable Blade .....	233

## Z

Zanger Abdominal Aorta Clamps.....	654
Zaufal-Jansen Rongeur.....	1037
Zenker Forceps.....	254
Z-Hysterectomy Forceps .....	256
Ziegler Cilia Forceps .....	1110
Zipser Penis Clamp.....	295



# INDEX

## Item Number

### 0

001200.....	380	050120.....	508	054500.....	185	070107.....	528
001201.....	380	050190.....	508	054590.....	206	070114.....	190, 490
001204.....	380	050200.....	23	054600.....	205	070116.....	192, 491
001205.....	380	050201.....	24	054620.....	201	070140.....	529
002200.....	379	050202.....	24	054720.....	520	070202.....	527
002204.....	379	050203.....	24	055100.....	134	070222.....	528
003200.....	380	050204.....	24	055102.....	1119	070232.....	528
003204.....	380	050205.....	24	055102.....	1119	070300.....	526
004200.....	380	050206.....	24	055135.....	151	070301.....	526
004204.....	380	050207.....	24	055200.....	151	070302.....	526
005200.....	380	050208.....	24	055502.....	132, 116	070303.....	526
020100.....	495	050209.....	24	056110.....	142	070305.....	526
020120.....	494	050211.....	24	056120.....	110	070312.....	525
020121.....	494	050212.....	24	056200.....	139	070330.....	525
020130.....	496	050213.....	24	056201.....	139	070332.....	525
020155.....	497	050230.....	23	056302.....	513	070334.....	525
020165.....	497	051082.....	509, 992	056310.....	122	070340.....	524
020204.....	499	051084.....	509, 992	056360.....	513	070342.....	524
020210.....	498	051086.....	509, 992	056400.....	512	070344.....	524
020211.....	498	051088.....	509, 992	056650.....	506	070450.....	526
020300.....	494	051090.....	509, 992	057150.....	505	070501.....	521
020302.....	494	051092.....	509, 992	057200.....	35	070502.....	521
020571.....	495	051095.....	509, 992	057202.....	35	070503.....	521
025100.....	499	051102.....	509, 995	057205.....	35	070511.....	521
025101.....	499	051103.....	509, 995	057207.....	43	070512.....	521
025102.....	499	051104.....	509, 995	057210.....	43	070521.....	521
025103.....	499	051105.....	509, 995	057212.....	43	070522.....	521
025104.....	499	051106.....	509, 995	057214.....	43	070523.....	521
025160.....	500	051107.....	509, 995	057215.....	45	070600.....	522
025162.....	500	051109.....	509	057220.....	44	070604.....	521
025163.....	500	051110.....	509, 995	057230.....	43	070605.....	521
025164.....	500	051150.....	508	057250.....	44	070635.....	532
025165.....	500	051152.....	508	057302.....	46	070640.....	532
025166.....	500	051155.....	508	060100.....	217	070651.....	531
025167.....	500	051158.....	508	060101.....	217	070652.....	531
025168.....	500	051190.....	508	060105.....	217	070660.....	531
025169.....	500	051191.....	508	060120.....	190, 759	070665.....	531
026275.....	192	051195.....	508	065100.....	315, 567	070701.....	517
026510.....	502	051510.....	1011	065105.....	315, 567	070701.....	532
027100.....	39	051520.....	1013	065108.....	315, 568	070702.....	517, 532
028120.....	1029	051521.....	1013	065109.....	315, 568	070704.....	517, 532
029350.....	494	051525.....	1013	065110.....	318, 567	070705.....	517, 532
029480.....	501	051526.....	1013	065111.....	318, 567	070706.....	517, 532
029550.....	219	052100.....	511, 997	065125.....	315, 567	072120.....	522
029555.....	219	052130.....	510, 975	065145.....	315, 567	072122.....	522
030100.....	518	052162.....	509, 974	065151.....	318	072124.....	522
030180.....	518	052165.....	510, 974	065152.....	318	073370.....	533
030301.....	518	052180.....	510, 975	065155.....	319, 568	073500.....	529
030302.....	518	053102.....	504	065165.....	317	073502.....	529
030303.....	518	053115.....	503	065166.....	316	074115.....	530
030304.....	518	053120.....	504	065170.....	317	074120.....	530
031100.....	39	053135.....	503	065172.....	316, 568	074140.....	530
031430.....	505	053135.....	959	065173.....	316, 568	075116.....	72
031500.....	507	054015.....	189	065175.....	319, 569	075118.....	63
031502.....	507	054016.....	189	065181.....	318	075120.....	72
031505.....	507	054100.....	187	065190.....	317	075122.....	72
031750.....	512	054102.....	187	065195.....	318	087396.....	327
031800.....	513	054105.....	187	065196.....	318	087403.....	327
036100.....	508	054107.....	187	065199.....	321, 572	087405.....	327
036110.....	508	054110.....	187	065202.....	1026	087419.....	327
036111.....	508	054120.....	185	065212.....	1034	087420.....	327
036500.....	503	054125.....	187	065300.....	957	087531.....	340
036501.....	503	054126.....	186	065325.....	949	087532.....	340
037101.....	511	054128.....	186	066100.....	132, 116	087533.....	340
037500.....	517	054130.....	186	066102.....	132, 116	087550.....	
037510.....	517	054135.....	185	066104.....	132, 116	087552.....	
037512.....	517	054140.....	187	066200.....	684, 1121	087559.....	
		054142.....	187	066204.....	684, 1121	087561.....	
		054144.....	187	070100.....	529	087702.....	
		054165.....	191	070101.....	529	087747.....	





087748.....	322	131114A.....	781	152720.....	163	164134.....	208
087749.....	322	137061.....	381	152722.....	163	164164.....	214
087750.....	322	137062.....	381	152724.....	163	164166.....	214
<b>1</b>		137081.....	381	152760.....	159	164168.....	214
101010.....	351	137082.....	381	152762.....	159	164170.....	214
101011.....	351	137085.....	381	152764.....	159	164172.....	214
101012.....	352	137086.....	381	152771.....	161	164174.....	214
101013.....	352	137111.....	381	152772.....	163	164374.....	193
101014.....	352	137112.....	381	152780.....	161	164376.....	193
101015.....	352	137117.....	381	152781.....	161	164384.....	193
101016.....	351	137118.....	381	152782.....	161	164402.....	194
101017.....	351	140875.....	1151	152784.....	161	164403.....	194
101022.....	350	140877.....	1151	152786.....	161	164404.....	194
101023.....	350	140878.....	1151	152790.....	161	164406.....	194
101024.....	350	140879.....	1151	152792.....	161	164412.....	194
101027.....	352	140880.....	1151	152796.....	168	164413.....	194
101028.....	350	140881.....	1151	152798.....	152	164414.....	194
101031.....	353	140882.....	1151	152800.....	154	164416.....	194
101032.....	353	141106.....	114	152802.....	154	164443.....	193
101033.....	353	141146.....	114	152805.....	155	164444.....	193
101034.....	353	141310.....	114	152808.....	156	164446.....	193
101035.....	356	141312.....	114	152818.....	176, 681, 802	164453.....	193
101036.....	356	141315.....	114	152819.....	176, 681	164454.....	193
101037.....	356	141317.....	114	152825.....	176, 683	164456.....	193
101038.....	356	141332.....	115	152827.....	176, 683	164520.....	210
101039.....	355	141395.....	119	152837.....	167	164521.....	210
101050.....	325	141448.....	122	152842.....	170	164522.....	210
101054.....	325	141450.....	122	152850.....	174	164525.....	211
101061.....	325	141452.....	122	152855.....	169	164526.....	211
101075.....	326	141460.....	123	162210.....	244	164527.....	211
101130.....	354	141462.....	123	162212.....	244	164528.....	211
101131.....	354	141467.....	123	162300.....	244	164540.....	211
101140.....	355	141469.....	123	162301.....	244	164542.....	212
101141.....	355	142220.....	116	162310.....	246, 765	164543.....	212
101142.....	354	142235.....	116	162345.....	245	164544.....	212
101143.....	354	142237.....	116	162410.....	243	164550.....	212
101144.....	355	142312.....	108	162411.....	243	164630.....	198
101145.....	355	142325.....	106	162412.....	243	164631.....	198
101146.....	354	142415.....	103	162413.....	243	164632.....	198
101147.....	349	142420.....	103	162414.....	243	164635.....	201
101148.....	349	142422.....	103	162415.....	243	164636.....	201
101149.....	349	142425.....	101	162416.....	243	164637.....	201
101150.....	349	142452.....	105	162421.....	243	164650.....	196
101151.....	351	142515.....	111	163000.....	241	164652.....	196
101152.....	351	142518.....	111	163100.....	241, 411	164656.....	196
114527.....	385	142519.....	823	163102.....	241	164658.....	196
121380.....	348	142520.....	823	163103.....	241	164698.....	205
121381.....	348	142521.....	182, 684	163104.....	241	164700.....	203
121382.....	348	142550.....	743, 823	163108.....	241	164702.....	203
121383.....	348	144295.....	132, 1113	163109.....	241	164710.....	204
121384.....	348	144300.....	135	163111.....	241	164715.....	207
121385.....	348	144310.....	135	163117.....	241	164750.....	206
121386.....	348	144315.....	135	163200.....	241	164752.....	206
121387.....	348	144317.....	135	163201.....	241	164754.....	202
121388.....	348	144319.....	142	163203.....	241	164786.....	188
121389.....	348	144321.....	142	163211.....	241	164790.....	200
121390.....	348	144330.....	142	163212.....	241	164865.....	197
121391.....	348	144332.....	142	163213.....	241	164865.....	745
121410.....	25	144338.....	137	163400.....	241	165085.....	217
121412.....	25	144340.....	137	163401.....	241	165086.....	217
121415.....	25	144350.....	141	163406.....	241	165100.....	231
121417.....	25	144352.....	141	163420.....	241	165105.....	231
121422.....	25	151210.....	320	163422.....	241	165107.....	232
121425.....	25	151222.....	320	163424.....	241	165130.....	231
121427.....	25	151228.....	320	163436.....	242	165133.....	231
121600.....	30	151240.....	320	163701.....	242	165135.....	231
121605.....	30	151350.....	348	164110.....	208	165137.....	231
121610.....	31	151351.....	348	164112.....	208	165138.....	231
121640.....	31	152255.....	314	164115.....	208	165141.....	233
121650.....	31	152256.....	314	164118.....	208	165142.....	2:
121655.....	29	152402.....	163	164120.....	208	165143.....	2:
121656.....	29	152406.....	163	164122.....	208	165145.....	2:
		152448.....	157	164125.....	208	165146.....	2:
		152496.....	153	164130.....	208	165147.....	2:
		152710.....	150	164132.....	208	165149.....	2:



165150.....	233	168000.....	239	175033.....	250	175113.....	254
165160.....	233	168101.....	239	175034.....	250	175114.....	249
165170.....	234	168103.....	239	175035.....	250	175115.....	249
165171.....	234	168104.....	239	175036.....	250	175116.....	249
165200.....	230	168105.....	239	175037.....	250	175117.....	249
165203.....	230	168110.....	239	175038.....	255	175118.....	256
165240.....	230	168111.....	239	175039.....	255	175119.....	256
165300.....	234	168201.....	239	175040P.....	259	175120.....	256
165348.....	218	168202.....	239	175041.....	259	175121.....	256
165350.....	218	168203.....	239	175042.....	257	175122.....	256
165352.....	218	168210.....	239	175043.....	257	175123.....	256
165354.....	218	168211.....	239	175045.....	257	175124.....	256
165356.....	218	168212.....	239	175046.....	257	175125.....	256
165358.....	218	168213.....	239	175048.....	257	181102.....	34
165360.....	218	168220.....	239	175049.....	257	181104.....	34
165362.....	218	168221.....	239	175052.....	257	181106.....	34
165364.....	218	168222.....	239	175053.....	252	181108.....	34
165366.....	218	168254.....	239	175054.....	252	181127.....	41
165370.....	221	168257.....	239	175055.....	249	181129.....	41
165372.....	221	171117.....	91	175056.....	249	181131.....	41
165374.....	221	171120.....	91	175057.....	253	181133.....	41
165380.....	221	171122.....	91	175058.....	259	181139.....	41
165382.....	221	171155.....	66	175059.....	255	181155.....	41
165384.....	221	172495.....	84	175060.....	255	181166.....	41
165400.....	223	172500.....	83	175061.....	257	181220.....	34
165402.....	223	172503.....	83	175062.....	260	181223.....	43
165439.....	224	172506.....	83	175063.....	260	181225.....	43
165439.....	802	172525.....	81	175065.....	260	181228.....	43
165440.....	224	172530.....	80	175066.....	260	181235.....	44
165510.....	217	172531.....	80	175067.....	257	181237.....	35
165550.....	218	172532.....	80	175068.....	257	181240.....	45
165552.....	218	172550.....	78	175069.....	258	181250.....	51
165590.....	216	172560.....	98	175070.....	258	181255.....	46
165591.....	216	172570.....	93	175071.....	258	181270.....	41
165592.....	216	172571.....	93	175072.....	258	181272.....	52
165595.....	216	172616.....	93	175073.....	252	181310.....	42
165596.....	216	172625.....	95	175074.....	252	181327.....	46
165597.....	216	172650.....	292	175075.....	258	181360.....	55
166000.....	242	172655.....	292	175076.....	258	181365.....	55
166002.....	242	172660.....	292	175077.....	258	181370.....	55
166480.....	307, 1126	172665.....	292	175078.....	261	181410.....	36
166485.....	307, 1126	172700.....	309	175079.....	261	181556.....	32
166490.....	307, 1126	175000.....	251	175080.....	261	181557.....	32
166495.....	307, 1126	175001.....	251	175081.....	261	181559.....	32
166500.....	308	175002.....	251	175082.....	261	181600.....	38
166501.....	308	175003.....	251	175083.....	249	181602.....	38
166502.....	308	175004.....	251	175084.....	249	181604.....	52
166503.....	308	175005.....	251	175085.....	249	181610.....	52
166504.....	308	175006.....	251	175086.....	249	181614.....	52
166505.....	308	175007.....	251	175087.....	249	181800.....	75
166507.....	308	175008.....	251	175088.....	249	181802.....	75
166520.....	308	175009.....	251	175089.....	258	181804.....	74
166521.....	308	175010P.....	251	175090.....	258	181806.....	75
166522.....	308	175011.....	251	175091.....	258	181808.....	75
166523.....	308	175012.....	251	175092.....	253	181810.....	75
166527.....	308	175013.....	251	175093.....	252	181812.....	75
166571.....	307	175014.....	254	175094.....	252	181814.....	75
166573.....	307	175015P.....	254	175095.....	253	181816.....	75
166610.....	307	175016.....	252	175096.....	254	181818.....	75
166611.....	307	175017.....	252	175097.....	254	181820.....	75
166612.....	307	175018.....	252	175098.....	254	181822.....	61
166613.....	307	175019.....	252	175099.....	254	181824.....	74
166632.....	307	175020P.....	256	175100.....	254	181830.....	68
166633.....	307	175021.....	259	175101.....	254	181832.....	75
166851.....	341	175022.....	259	175102.....	255	182050.....	60
166853.....	341	175023.....	261	175103.....	255	182060.....	60
166855.....	341	175024.....	261	175104.....	250	182070.....	60
166857.....	341	175025P.....	261	175105.....	250	182080.....	60
166859.....	341	175026.....	250	175106.....	250	182085.....	60
166861.....	341	175027.....	250	175107.....	250	182086.....	60
166868.....	340	175028.....	250	175108.....	250	182090.....	60
166870.....	340	175029.....	250	175109.....	249	182095.....	60
166872.....	340	175030P.....	250	175110.....	249	182097.....	60
166874.....	340	175031.....	250	175111.....	253	182098.....	60
166876.....	340	175032.....	250	175112.....	253	182100.....	60



182110.....65  
 182120.....71  
 182130.....71  
 182140.....71  
 182150.....71  
 182160.....65  
 182200.....73  
 182205.....73  
 182210.....73  
 182300.....62  
 182310.....62  
 182350.....62  
 182355.....62  
 182390.....72  
 182400.....68  
 182405.....68  
 182415.....68  
 182420.....68  
 182440.....68  
 182445.....68  
 182455.....68  
 182460.....68  
 182600.....70  
 182605.....70  
 182615.....70  
 182620.....70  
 182655.....70  
 182665.....70  
 182670.....70  
 182795.....88  
 182850.....88  
 182860.....88  
 182870.....88  
 182875.....88  
 182880.....88  
 182900.....89  
 182905.....89  
 182910.....89  
 182915.....87  
 182920.....89  
 18305.....1165  
 183010.....90, 555  
 183020.....90, 555  
 183400.....99  
 183410.....99  
 183975.....96  
 183977.....96  
 184001.....96  
 184002.....96  
 184003.....96  
 185005.....87  
 185006.....87  
 185010.....87  
 185030.....95  
 185060.....67  
 185065.....67  
 185066.....67  
 185067.....67  
 185202.....95  
 185204.....95  
 185210.....97  
 185212.....97  
 185214.....97  
 185220.....98  
 185222.....98  
 185331.....92  
 185402.....100  
 185404.....100  
 185714.....190  
 188030.....1068  
 188032.....1068  
 191023.....1157  
 191025.....1157

2

200100.....360  
 200101.....360  
 200102.....360  
 200103.....360  
 200104.....361  
 200105.....361  
 200106.....361  
 200108.....361  
 200110.....361  
 200112.....361  
 200120.....361  
 200121.....361  
 200123.....361  
 200131.....361  
 200161.....360  
 200200.....359  
 200201.....359  
 200202.....359  
 200203.....359  
 200211.....359  
 200212.....359  
 200214.....362  
 200215.....362  
 200217.....362  
 200218.....363  
 200220.....358  
 200230.....363  
 200231.....363  
 200232.....363  
 200233.....364  
 200234.....364  
 200235.....364  
 200236.....364  
 200240.....358  
 200250.....358  
 200322.....365  
 200326.....365  
 200327.....365  
 200328.....365  
 200333.....366  
 200334.....366  
 200335.....366  
 200340.....366  
 200400.....357  
 200401.....357  
 200402.....357  
 200403.....357  
 200550.....346  
 202030.....298  
 202060.....304  
 202062.....304  
 202067.....304  
 202095.....305  
 202096.....305  
 202097.....305  
 202105.....303  
 202140.....301  
 202150.....301  
 202151.....301  
 202600.....306  
 202623.....305  
 202630.....306  
 202635.....306  
 202792.....306  
 202970.....298  
 203142.....299  
 204004.....300  
 204016.....300  
 204018.....300  
 211116A.....781  
 211117A.....781  
 211118A.....782

211245A.....782  
 211290A.....783  
 211325A.....783  
 211500.....784  
 211600.....784  
 211603A.....782  
 212000.....283  
 212001.....283  
 212002.....283  
 212005.....283  
 212010.....284  
 212011.....284  
 212012.....284  
 212185.....285  
 212187.....285  
 212195.....285  
 212196.....285  
 212197.....285  
 212225.....287  
 212226.....287  
 212227.....287  
 212228.....287  
 212229.....287  
 212241.....288  
 212242.....288  
 212263.....287  
 212264.....287  
 212265.....287  
 212271.....286  
 212275.....286  
 212295.....287  
 212305.....286  
 212350.....286  
 212500.....262  
 212505.....262  
 212600.....272  
 212605.....273  
 212610.....273  
 212612.....273  
 212647.....275  
 212659.....273  
 212661.....273  
 212662.....273  
 212663.....273  
 212664.....273  
 212665.....273  
 212666.....273  
 212667.....273  
 212668.....273  
 212669.....273  
 212670.....273  
 212671.....273  
 212673.....274  
 212675.....274  
 212676.....274  
 212677.....274  
 212678.....274  
 212679.....274  
 212680.....274  
 212681.....274  
 212682.....274  
 212749.....277  
 212750.....277  
 212751.....277  
 212752.....277  
 212753.....277  
 212754.....277  
 212755.....277  
 212905.....275  
 212910.....276  
 212930.....276  
 213011.....268  
 213036.....267  
 213050.....262  
 213055.....262

213065.....279  
 213080.....279  
 213085.....279  
 213090.....280  
 213095.....280  
 213100.....278  
 213110.....278  
 213120.....278  
 213140.....264  
 213150.....281  
 213155.....281  
 213157.....281  
 213160.....281  
 213175.....282  
 213180.....282  
 213230.....263  
 214081.....272  
 214090.....272  
 214161.....264  
 214170.....265  
 214172.....265  
 214175.....265  
 214180.....266  
 214182.....266  
 214215.....265  
 214230.....266  
 214550.....271  
 214555.....271  
 214570.....271  
 214595.....270  
 214605.....271  
 214687.....296  
 214688.....296  
 214689.....296  
 214691.....296  
 214770.....291  
 215558A.....783  
 237061.....381  
 237081.....381  
 237085.....381  
 237111.....381  
 237115.....381  
 237117.....381  
 237141.....381  
 237145.....381  
 238110.....381  
 238110T.....381  
 238170.....381  
 238200.....379  
 241108.....296  
 241110.....296  
 241112.....296  
 241114.....296  
 241116.....296  
 241118.....296  
 241120.....296  
 241122.....296  
 241124.....296  
 241126.....296  
 241128.....296  
 241130.....296  
 241132.....296  
 242005.....293  
 242006.....293  
 243110.....293  
 243200.....297  
 243201.....297  
 244000.....294  
 244001.....294

3

306010A.....115  
 32-0798K.....67





32-0799K .....	670	341448 .....	716	342203 .....	127, 668	342933 .....	53, 550
337081 .....	381	341450 .....	716	342204 .....	127, 668	342935 .....	53, 550
337085 .....	381	341460 .....	716	342206 .....	127, 668	342950 .....	53, 549
337111 .....	381	341501 .....	721, 753	342220 .....	130, 669	342965 .....	46
337115 .....	381	341502 .....	753	342221 .....	130, 669	342967 .....	46
337117 .....	381	341503 .....	753	342222 .....	130, 669	342980 .....	47, 544
337141 .....	381	341506 .....	753	342223 .....	130, 669	342981 .....	47, 544
337145 .....	381	341511 .....	753	342242 .....	129	342982 .....	47, 544
338110 .....	379	341512 .....	753	342243 .....	129	342984 .....	47, 544
338110T .....	381	341513 .....	753	342245 .....	129	342986 .....	47, 544
338170 .....	381	341514 .....	754	342270 .....	121	343000 .....	171, 675
341100 .....	726	341515 .....	755	342272 .....	121	343027 .....	169
341112 .....	726	341520 .....	721, 753	342273 .....	120	343030 .....	183, 684
341113 .....	726	341522 .....	721, 753	342275 .....	128	343030 .....	743
341114 .....	726	341523 .....	721, 753	342275 .....	668	343145 .....	716
341120 .....	723	341524 .....	721, 753	342501 .....	85	343148 .....	717
341123 .....	724	341525 .....	721, 753	342504 .....	85	343149 .....	717
341124 .....	724	341531 .....	751	342511 .....	85	343152 .....	717
341126 .....	724	341635 .....	202	342513 .....	85	343153 .....	717
341127 .....	724	341640 .....	201	342514 .....	85	343295 .....	767
341128 .....	724	341650 .....	215, 746	342533 .....	85	343393 .....	339, 725
341129 .....	724	341651 .....	215, 746	342557 .....	79	343395 .....	339
341131 .....	725	341678 .....	215, 744	342558 .....	79	343500 .....	981
341133 .....	725	341679 .....	215, 744	342559 .....	79	343501 .....	981
341136 .....	723	341690 .....	214, 746	342560 .....	94	343502 .....	981
341139 .....	723	341692 .....	214, 746	342561 .....	94	343503 .....	981
341147 .....	721	341694 .....	214, 746	342562 .....	94	343504 .....	981
341148 .....	722	341696 .....	214, 746	342563 .....	94	343505 .....	981
341149 .....	722	341698 .....	214, 746	342565 .....	94	343506 .....	981
341150 .....	720	341720 .....	209	342566 .....	76	343590 .....	559
341150 .....	742	341722 .....	209	342567 .....	76	35120 .....	1151
341154 .....	722	341730 .....	209	342568 .....	76	35150 .....	1151
341155 .....	721, 742	341732 .....	209	342569 .....	76	351316 .....	794
341156 .....	722	341740 .....	210	342571 .....	72	351318 .....	794
341158 .....	732, 741	341770 .....	211	342572 .....	72	351348 .....	183, 685
341160 .....	732, 741	341773 .....	211	342575 .....	84	351349 .....	182, 685
341162 .....	732, 742	341780 .....	213	342580 .....	87	351351 .....	26
341163 .....	733, 742	341790 .....	210	342583 .....	85	351352 .....	26
341164 .....	733, 742	341791 .....	210	342585 .....	56	351353 .....	26
341170 .....	738, 742	341795 .....	213, 747	342587 .....	57	351354 .....	26
341175 .....	734, 742	341797 .....	213, 747	342590 .....	73	351355 .....	26
341177 .....	734, 741	341803 .....	715	342594 .....	57	351358 .....	27
341178 .....	734, 741	341836 .....	714, 1036	342596 .....	78	351370 .....	27
341180 .....	739, 742	341950 .....	718	342597 .....	78	351373 .....	28
341181 .....	739, 742	341960 .....	718	342598 .....	78	351374 .....	28
341194 .....	733, 742	341961 .....	718	342600 .....	82	351375 .....	28
341195 .....	733, 742	341980 .....	719	342601 .....	82	351376 .....	28
341198 .....	737, 742	341985 .....	718	342603 .....	82	351377 .....	28
341200 .....	729, 741	341992 .....	747	342605 .....	97	351378 .....	28
341205 .....	730, 741	342000 .....	743	342606 .....	97	351390 .....	26
341224 .....	738, 742	342002 .....	743	342611 .....	81	351470 .....	761
341225 .....	737, 742	342004 .....	743	342615 .....	77	351472 .....	761
341227 .....	737, 742	342006 .....	743	342625 .....	84	351474 .....	761
341250 .....	729, 741	342008 .....	743	342632 .....	78	351476 .....	761
341290 .....	727, 741	342015 .....	756	342633 .....	78	351490 .....	761
341296 .....	730, 741	342020 .....	719	342655 .....	556	351500 .....	247, 766
341302 .....	727, 741	342025 .....	720	342660 .....	555	351501 .....	247, 766
341303 .....	728, 741	342040 .....	744	342662 .....	555	351502 .....	248, 766
341304 .....	728, 741	342043 .....	744	342664 .....	555	351504 .....	248, 766
341305 .....	728, 741	342044 .....	744	342670 .....	556	351505 .....	248, 765
341310 .....	740, 780	342102 .....	715	342672 .....	556	351506 .....	248, 766
341312 .....	727, 741	342105P .....	715	342675 .....	557	351508 .....	247
341315 .....	728, 741	342107 .....	715	342710 .....	554	351547 .....	247, 765
341317 .....	729, 741	342141 .....	715	342711 .....	554	351560 .....	764
341326 .....	731, 741	342142 .....	714	342720 .....	90, 558	351573 .....	764
341328 .....	731, 741	342143 .....	714	342721 .....	90, 558	351574 .....	764
341330 .....	731, 742	342160 .....	127, 667	342725 .....	90, 555	351575 .....	764, 803
341332 .....	731, 742	342162 .....	127, 667	342726 .....	90, 555	351576 .....	764
341362 .....	736, 741	342166 .....	127, 667	342800 .....	557	351577 .....	764
341366 .....	736, 741	342167 .....	127, 667	342802 .....	557	351578 .....	764
341387 .....	740	342168 .....	127, 667	342804 .....	555	351586 .....	764
341389 .....	740, 742	342169 .....	127, 667	342822 .....	558	351587 .....	764
341390 .....	736, 741	342200 .....	127, 668	342823 .....	558	351593 .....	764
341397 .....	735, 741	342201 .....	127, 668	342910 .....	55	351594 .....	764
341398 .....	735, 741	342202 .....	127, 668	342915 .....	55	351645 .....	764



351646.....	627	351827.....	54, 549, 803	352174.....	659	353064.....	560
351650.....	627	351829.....	54, 549	352177.....	659	353066.....	560
351651.....	627	351830.....	184, 679, 803	352178.....	661	353070.....	564
351652.....	627	351831.....	184, 679	352180.....	667	353075.....	566
351653.....	627	351835.....	53, 547	352181.....	667	353077.....	604
351654.....	627	351838.....	54, 547	352183.....	667	353078.....	604
351661.....	228	351839.....	54, 547	352184.....	667	353080.....	604
351661.....	750	351840.....	55	352185.....	659	353085.....	604
351664.....	228	351841.....	55	352187.....	658	353086.....	605
351664.....	750	351842.....	55	352191.....	659	353087.....	605
351666.....	229, 748	351843.....	49, 546	352196.....	659	353100.....	562
351667.....	229, 748	351845.....	49, 546	352197.....	659	353102.....	562
351668.....	229, 748	351850.....	40	352199.....	668	353105.....	562
351669.....	229, 748	351852.....	40	352210.....	127	353110.....	562
351670.....	229, 748	351854.....	40	352232.....	667	353112.....	562
351671.....	229, 748	351856.....	40	352235.....	122	353115.....	562
351672.....	229, 748	351858.....	40	352237.....	122	353120.....	562
351673.....	229, 748	351860.....	36	352240.....	118	353123.....	566
351675.....	229, 748	351861.....	37	352250.....	118	353124.....	566
351676.....	228, 749	351862.....	40	352295.....	671	353125.....	566
351677.....	228, 749	351863.....	40	352297.....	669	353126.....	566
351678.....	228, 749	351864.....	40	352298.....	669	353127.....	566
351679.....	227, 749	351865.....	40	352598.....	756	353128.....	566
351680.....	227, 749	351870.....	54	352605.....	772	353131.....	563
351685.....	216	351872.....	54	352606.....	673	353132.....	563
351715.....	655	351874.....	54	352607.....	673	353135.....	565
351737.....	759	351876.....	54	352610.....	772	353136.....	565
351743.....	557	351898.....	54	352611.....	772	353137.....	565
351744.....	557	351900.....	37, 547	352612.....	773	353138.....	565
351745.....	671	351901.....	51, 548	352613.....	773	353140.....	570
351747.....	752	351901DG.....	549	352614.....	773	353142.....	570
351748.....	549	351902.....	37, 547	352615.....	760	353150.....	561
351749.....	758	351905.....	50, 548	352630.....	760	353151.....	561
351750.....	755	351907.....	50, 548	352680.....	773	353152.....	561
351752.....	755	351908.....	51, 548	352681.....	773	353153.....	561
351754.....	755	351909.....	51, 548	352682.....	773	353154.....	561
351755.....	755	351910.....	51, 548	352683.....	773	353155.....	561
351763.....	755	351970.....	776	352690.....	773	353182.....	602
351767.....	752	352090.....	118	352691.....	773	353183.....	603
351768.....	752	352100.....	128	352692.....	773	353186.....	602
351769.....	752	352103P.....	128	352693.....	773	353187.....	603
351770.....	752	352106.....	128	352705.....	768	353187.....	802
351771.....	752	352109.....	128	352800.....	757	353189.....	602
351772.....	752	352120.....	128	352802.....	757	353190.....	603
351773.....	751	352123.....	128	352804.....	757	353190.....	802
351774.....	751	352126.....	128	352806.....	757	353192.....	602
351779.....	226	352129.....	128	352808.....	757	353195.....	602
351779.....	750	352132P.....	657	352810.....	757	353203.....	795
351780.....	752	352133.....	657	352825.....	763	353206.....	795
351783.....	754	352134.....	657	352950.....	22	353207.....	795
351784.....	229	352135.....	657	352951.....	22	353490.....	97, 621
351784.....	748, 758	352136.....	657	352952.....	22	353491.....	97, 621
351788.....	751	352140.....	663	352953.....	22	353492.....	97, 621
351789.....	751	352144.....	673, 1113	352954.....	22	353494.....	620
351790.....	751	352145.....	673, 803, 1112	352957.....	22	353495.....	620
351791.....	751	352146.....	662	352959.....	22	353496.....	620
351800.....	48, 544	352147.....	662	353001.....	564	353500.....	616
351801.....	48, 546	352148.....	662	353002.....	564	353503.....	616
351802.....	48, 544	352149.....	662	353003.....	564	353510.....	617
351803.....	48, 546	352150.....	664	353011.....	564, 803	353513.....	617
351803DG.....	546	352151.....	660	353012.....	564	353515.....	611
351804.....	48, 544	352152.....	664	353014.....	564	353522.....	611
351806.....	48, 546	352153.....	660	353016.....	564	353524.....	611
351808.....	48, 544	352154.....	664	353025.....	563	353528.....	612
351810.....	48, 544	352155.....	660	353035.....	567	353531.....	610
351812.....	48, 544	352162.....	662	353040.....	569	353532.....	610
351814.....	48, 544	352164.....	661	353041.....	569	353533.....	610
351815.....	49, 545	352165.....	661	353042.....	569	353534.....	610
351817.....	49, 545	352166.....	661	353043.....	569	353535.....	614
351818.....	49, 545	352167.....	661	353050.....	560	353536.....	61
351819.....	49, 545	352168.....	661	353052.....	560	353538.....	61
351820.....	48, 545	352169.....	656	353054.....	560	353539.....	61
351821.....	48, 545	352170.....	664	353056.....	560	353540.....	61
351824.....	49, 545	352171.....	664	353060.....	560	353541.....	61
351825.....	54, 549, 803	352173.....	659	353062.....	560	353542.....	61



353543	612	353802	636	354472	587	354982	172, 676
353545	614	353806	634	354474	588	354985	173, 677
353546	633	353810	635	354476	588	354986	173, 677
353550	616	353812	635	354482	588	354987	173, 677
353560	92, 615	353815	635	354484	588	354988	173, 677
353562	92, 615	353817	635	354486	588	354990	160, 678
353565	92, 615	353825	636	354488	578	354992	160, 678
353567	615	353827	636	354490	578	354994	160, 678
353568	613	353835	637	354494	578	354996	160, 678
353569	605	353837	637	354496	578	354998	160, 678
353570	606	353840	637	354500	631	355055	76
353571	606	353842	637	354501	631	355080	770
353580	641	353860	646	354720	594	355081	770
353581	642	353862	646	354721	594	355082	770
353582	641	353865	646	354722	594	355083	770
353583	642	353872	100	354723	594	355084	770
353584	641	354000	645	354724	594	355085	770
353585	640	354002	645	354729	591	355086	770
353586	640	354004	645	354730	591	355087	770
353588	642	354005	645	354735	592	355088	770
353595	654	354010	645	354737	592	355089	770
353596	654	354031	638	354739	592	355090	770
353597	654	354032	638	354750	589	355091	770
353600	650, 803	354033	638	354755	593	355092	770
353602	650	354034	638	354800	601	355093	770
353605	650	354084	629	354801	601	355094	770
353607	650	354087	629	354802	601	355095	770
353609	653	354100	630	354803	601	355096	770
353610	653	354102	630	354804	601	355097	770
353617	643	354125	596	354805	600	355098	770
353618	643	354135	618	354806	600	355099	770
353619	643	354136	618	354807	600	355100	771
353620	639	354137	618	354808	601	355101	771
353622	639	354165	644	354810	596	355175	758
353623	629	354170	634	354815	599	355180	793
353625	652	354180	593	354816	599	355182	793
353626	652	354185	593	354817	599	355184	793
353627	652	354190	590	354826	597	355186	793
353630	651	354191	590	354827	597	355191	793
353631	651	354320	655	354830	597	355192	793
353632	651	354400	582	354835	598	355194	503, 717
353635	651	354402	582	354836	598	355194	793, 957
353639	622	354404	582	354839	622	355196	605
353640	553	354406	582	354845	596	355198	607
353641	648	354408	583	354847	600	355275	771, 802
353642	648	354410	583	354900	170, 674	355276	771, 802
353643	648	354412	583	354902	170, 674	355277	771, 802
353645	554	354414	584	354904	170, 674	355278	771, 802
353646	554	354416	584	354906	170, 674	355285	769
353647	553	354420	579	354908	170, 674	355286	323, 769
353650	649	354422	579	354915	174, 678	355287	769
353651	653	354424	579	354916	174, 678	355288	769
353653	653	354427	589	354917	174, 678	355290	769
353655	647	354428	577	354920	171, 675	355291	323, 769
353656	647	354430	577	354928	171, 675	355292	769
353657	606	354432	577	354931	169, 674	355295	769
353658	654	354434	580	354941	172, 676	355296	769
353660	633	354435	591	354958	173, 677	355297	769
353662	633	354436	580	354959	173, 677	355298	769
353664	633	354438	580	354960	173, 677	355299	769
353666	633	354442	581	354961	173, 677	355300	769
353668	633	354444	581	354962	173, 677	355301	769
353670	633	354446	581	354964	178, 680, 802	355302	769
353672	646	354448	584	354964DG	178, 681	355303	769
353674	646	354450	586	354965	178, 680	355304	769
353680	632	354452	586	354965DG	178, 681	355305	769
353682	632	354454	586	354966	179, 680	355306	769
353684	632	354456	585	354967	179, 680	355309	768
353686	632	354458	585	354969	179, 680	355310	768
353690	632	354460	585	354971	179, 679	355311	
353692	632	354462	585	354972	681	355312	
353694	632	354464	587	354973	681	355313	
353696	632	354466	587	354974	681	355314	
353700	619	354468	587	354975	681	355315	
353800	636	354470	587	354981	172, 676	355490	



355492.....	797	357643.....	666	359073.....	707	359268.....	705
355493.....	797	357645.....	552	359074.....	707	359269.....	705
355495.....	796	357645DG.....	552	359075.....	707	359270.....	705
355497.....	796	357647.....	552	359080.....	711	359271.....	705
355500.....	796	357647DG.....	552	359082.....	711	359272.....	705
355558DG.....	177, 681	357648.....	552	359083.....	710	359273.....	705
355559DG.....	177, 681	357648DG.....	552	359085.....	710	359274.....	705
355560DG.....	177, 681	357650.....	798	359092.....	712	359275.....	705
355798.....	77	357651.....	672, 798	359093.....	712	359276.....	705
355799.....	77	357652.....	672, 798	359097.....	712	359277.....	705
355800.....	77	357653.....	666, 798	359099.....	709	359278.....	705
355801.....	77	357654.....	175, 683, 798	359102.....	709	359279.....	705
355810.....	793	357655.....	175, 683, 798	359103P.....	709	359280.....	705
355819.....	561	357656.....	175, 683, 798	359104.....	709	359281.....	705
355830.....	794	357656DG.....	178, 681	359105.....	709	359282.....	705
355832.....	794	357657.....	175, 683, 798	359110.....	711	359283.....	691
355834.....	794	357658.....	551, 798	359111.....	711	359284.....	691
355838.....	794	357659.....	551, 798	359112.....	711	359296.....	692
356000.....	547	357660.....	551, 798	359113P.....	711	359299.....	692
356002.....	547	357661.....	551, 798	359118.....	712	359307.....	692
356003.....	547	357667.....	175, 683	359119.....	712	359313.....	701
356025.....	627	357672.....	175, 683	359122.....	703	359314.....	699
356027.....	623	357674.....	175, 683	359123.....	703	359321.....	701
356028.....	623	357675.....	175, 683	359124.....	703	359325.....	696
356031.....	627	357676.....	175, 683	359127.....	703	359328.....	708
356040.....	626	357676DG.....	178, 681	359128.....	703	359329.....	708
356041.....	626	357677.....	175, 683	359131.....	703	359335.....	708
356045.....	623	357677DG.....	178, 681	359138.....	699	359339.....	708
356046.....	623	357681.....	550	359139.....	699	359340.....	707
356051.....	625	357690.....	663	359152.....	700	359342.....	707
356052.....	625	357691.....	663	359159.....	698	359343.....	707
356053.....	625	358001.....	180, 682	359160.....	700	359344.....	708
356060.....	648	358002.....	180, 682	359161.....	697	359345.....	708
356070.....	624	358003.....	180, 682	359162.....	697	359346.....	708
356071.....	624	358007.....	553	359163.....	697	359347.....	708
356072.....	624	358344.....	717	359169.....	701	359349.....	708
357100.....	576	358350.....	961	359170.....	701	359350.....	708
357102.....	576	359003.....	704	359171.....	701	359352.....	708
357106.....	576	359006.....	704	359173.....	698	359353.....	713
357110.....	576	359016.....	706	359181.....	698	359354.....	695
357180.....	607	359017.....	706	359183.....	698	359355.....	695
357185.....	607	359018.....	706	359184.....	698	359356.....	695
357191.....	575	359019.....	706	359185.....	697	359357.....	695
357192.....	575	359020.....	706	359186.....	697	359358.....	695
357194.....	608	359021.....	50, 688	359187.....	697	359359.....	686
357195.....	609	359022.....	50, 688	359188.....	697	359360.....	687
357197.....	608	359024.....	50, 688	359191.....	702	359361.....	686
357198.....	609	359025.....	50, 688	359193.....	702	359381.....	709
357200.....	575	359027.....	50, 688	359194.....	699	359382.....	712
357202.....	575	359028.....	50, 688	359195.....	698	359383.....	713
357262.....	575	359029.....	50, 688	359201.....	693	359401.....	707
357270.....	575	359030.....	50, 688	359206.....	693	359402.....	707
357302.....	595	359031.....	50, 688	359208.....	693	359403.....	707
357304.....	595	359032.....	50, 688	359209.....	694	359407.....	690
357306.....	595	359033.....	691	359210.....	694	380200.....	214
357308.....	595	359034.....	691	359211.....	694	380202.....	214
357310.....	595	359036.....	691	359212.....	694	380204.....	214
357532.....	759	359037.....	691	359213.....	694	380206.....	214
357580.....	571	359042.....	691	359214.....	694	380208.....	214
357581.....	571	359043.....	686	359215.....	694	380210.....	214
357582.....	571	359048.....	689	359221.....	695	381801A.....	1153
357583.....	571	359049.....	689	359236.....	696	382710.....	221
357586.....	571	359050.....	690	359237.....	696	382722.....	220
357590.....	572	359051.....	689	359238.....	702	382800.....	367
357591.....	572	359052.....	687	359250.....	704	382805.....	367
357592.....	572	359053.....	687	359253.....	704	386152.....	1037
357593.....	572	359054.....	690	359259.....	705	392012.....	1157
357594.....	666	359055.....	708	359260.....	705	392014.....	1157
357595.....	666	359058.....	708	359261.....	705	392018.....	1158
357601.....	180, 683	359059.....	708	359262.....	705	392026.....	1158
357603.....	180, 683	359061.....	708	359263.....	705	392028.....	1158
357603DG.....	179, 682	359062.....	708	359264.....	705	392034.....	1158
357622.....	666	359063.....	708	359265.....	705	392036.....	1158
357623.....	672	359069.....	707	359266.....	705	392040.....	1158
357642.....	666	359071.....	707	359267.....	705	392043.....	1158



392204.....	1157	423430.....	1118	431120.....	519	447030.....	45
394236.....	1158	423432.....	1118	431130.....	519	447050.....	30
394237.....	1158	423434.....	1118	431325.....	505	450205.....	24
394238.....	1158	423438.....	1118	431360.....	506	452510.....	523
394246.....	1156	423440.....	1120	431362.....	506	452550.....	523
394247.....	1156	423450.....	1114	431366.....	506	452551.....	523
394250.....	1156	423460.....	1114	431425.....	512	454100.....	25
394258.....	1156	423480.....	1115	431433.....	514	454300.....	30
394267.....	1156	423490.....	1115	431437.....	514	454305.....	30
394430.....	551, 1107	424100.....	1121	431440.....	514	454320.....	29
394431.....	551, 1107	424102.....	1121	431445.....	515	454322.....	29
394807.....	1156	424110.....	1121	431446.....	515	456002.....	23
394811.....	1156	424170.....	1121	431451.....	515	456005.....	23
395115.....	672	424180.....	1121	431452.....	515	456006.....	23
395118.....	39	424190.....	1121	431461.....	515	456007.....	23
395128.....	672	425190.....	1107	431462.....	515	460100.....	113
		425191.....	1107	431463.....	515	460105.....	113
		425200.....	1106	431480.....	515	460110.....	113
		425210.....	1106	431481.....	516	460115.....	113
		425312.....	1104	431488.....	516	460135.....	113
		425350.....	1102	431710.....	516	460140.....	113
		425360.....	1104	431711.....	516	460165.....	113
		425380.....	1104	431728.....	516	460170.....	113
		425390.....	1104	431729.....	516	460175.....	113
		425510.....	1111	431732.....	516	460177.....	113
		425520.....	1111	431733.....	516	460179.....	113
		425530.....	1111	432007.....	516	460180.....	112
		425560.....	1105	437081.....	381	460188.....	113
		425590.....	1104	437085.....	381	460219.....	113
		425605.....	1106	437111.....	381	460220.....	113
		425700.....	1108	437115.....	381	460245.....	113
		425710.....	1108	437117.....	381	460400.....	115
		425720.....	1108	437141.....	381	460410.....	115
		425730.....	1108	437145.....	381	460420.....	115
		425740.....	1108	438110.....	381	460430.....	115
		425750.....	1108	438170.....	381	460460.....	115
		426010.....	1126	441207.....	509, 995	460461.....	115
		426040.....	1127	441208.....	509, 995	460600.....	117
		426050.....	1127	441420.....	1014	460601.....	117
		426080.....	1127	441530.....	510, 975	460620.....	115
		426090.....	307, 1126	441555.....	511, 976	460630.....	115
		426092.....	307, 1126	441730.....	503	460720.....	119
		426094.....	307, 1126	441740.....	504	460820.....	124
		426096.....	307, 1126	442100.....	187	460821.....	124
		426098.....	307, 1126	442102.....	187	460830.....	123
		427002.....	307, 1126	442104.....	187	460840.....	124
		427370.....	1106	442106.....	187	460841.....	124
		427382.....	1106	442108.....	187	460870.....	124
		427384.....	1106	442110.....	188	460871.....	124
		427390.....	1104	442145.....	185	460873.....	131
		427392.....	1102	442147.....	185	460880.....	124
		427400.....	1102	442210.....	196	460881.....	124
		427410.....	1102	442245.....	203	460883.....	131
		427420.....	1105	442260.....	202	460884.....	124
		428630.....	311, 1130	442288.....	214	460885.....	124
		428650.....	1128	442295.....	195	460889.....	124
		428655.....	1128	442502.....	139	461125.....	527
		429317.....	1131	442510.....	136	461126.....	527
		429318.....	1131	442512.....	136	461128.....	527
		429430.....	1131	442515.....	141	461310.....	131
		429512.....	1129	442525.....	140	461311.....	131
		429520.....	1129	442560.....	121	461350.....	522
		429524.....	1129	442576.....	140	461351.....	522
		429526.....	1128	443100.....	151	461352.....	522
		429527.....	1128	443120.....	152	461353.....	522
		429532.....	1129	443480.....	507	461354.....	522
		429534.....	1129	443480.....	1111	461430.....	137
		429546.....	1128	443500.....	73	461431.....	137
		429548.....	1128	443502.....	73	461600.....	523
		429566.....	1128	443505.....	73	461605.....	523
		429594.....	323, 798	443507.....	73	461610.....	
		429601.....	323	443508.....	73	461615.....	
		431110.....	519	443510.....	73	461660.....	
		431111.....	519	443512.....	73	461661.....	
		431112.....	519	443610.....	507	462105.....	
				447025.....	36	462110.....	

## 4

405188.....	1167	405910R.....	1167	405912.....	1167	405933L.....	1167
411140.....	500	411145.....	500	411165.....	501	411166.....	501
411200.....	493	411201.....	493	411202.....	493	411203.....	493
411204.....	493	411230.....	493	411231.....	493	411232.....	493
411241.....	493	411304.....	501	411331.....	520, 1130	411515.....	496
411520.....	495	411525.....	496	411535.....	497	411540.....	497
411625.....	1058	411700.....	245	411702.....	245	411704.....	245
411720.....	245	411724.....	245	411726.....	245	411727.....	245
411728.....	245	412944L.....	1167	421140.....	1122	421141.....	1122
421142.....	1122	421200.....	1123	421510.....	216, 1125	421512.....	216, 1125
421610.....	197	421620.....	197	421630.....	197	421640.....	197
422180.....	1123	422190.....	1123	422200.....	1123	422250.....	1123
423320.....	1112	423330.....	1112	423340.....	1112	423410.....	1115
423422.....	1114	423425.....	1120	423428.....	1118	423430.....	1118
423432.....	1118	423434.....	1118	423438.....	1118	423440.....	1120
423450.....	1114	423460.....	1114	423480.....	1115	423490.....	1115
424100.....	1121	424102.....	1121	424110.....	1121	424170.....	1121
424180.....	1121	424190.....	1121	425190.....	1107	425191.....	1107
425200.....	1106	425210.....	1106	425312.....	1104	425350.....	1102
425360.....	1104	425380.....	1104	425390.....	1104	425510.....	1111
425520.....	1111	425530.....	1111	425560.....	1105	425590.....	1104
425605.....	1106	425700.....	1108	425710.....	1108	425720.....	1108
425730.....	1108	425740.....	1108	425750.....	1108	426010.....	1126
426040.....	1127	426050.....	1127	426080.....	1127	426090.....	307, 1126
426092.....	307, 1126	426094.....	307, 1126	426096.....	307, 1126	426098.....	307, 1126
427002.....	307, 1126	427370.....	1106	427382.....	1106	427384.....	1106
427390.....	1104	427392.....	1102	427400.....	1102	427410.....	1102
427420.....	1105	428630.....	311, 1130	428650.....	1128	428655.....	1128
429317.....	1131	429318.....	1131	429430.....	1131	429512.....	1129
429520.....	1129	429524.....	1129	429526.....	1128	429527.....	1128
429532.....	1129	429534.....	1129	429546.....	1128	429548.....	1128
429566.....	1128	429594.....	323, 798	429601.....	323	431110.....	519
431111.....	519	431112.....	519	431120.....	519	431130.....	519
431325.....	505	431360.....	506	431362.....	506	431366.....	506
431425.....	512	431433.....	514	431437.....	514	431440.....	514
431445.....	515	431446.....	515	431451.....	515	431452.....	515
431461.....	515	431462.....	515	431463.....	515	431480.....	515
431481.....	516	431710.....	516	431711.....	516	431728.....	516
431729.....	516	431732.....	516	431733.....	516	432007.....	516
437081.....	381	437085.....	381	437111.....	381	437115.....	381
437117.....	381	437141.....	381	437145.....	381	438110.....	381
438170.....	381	441207.....	509, 995	441208.....	509, 995	441420.....	1014
441530.....	510, 975	441555.....	511, 976	441730.....	503	441740.....	504
442100.....	187	442102.....	187	442104.....	187	442106.....	187
442108.....	187	442110.....	188	442145.....	185	442147.....	185
442210.....	196	442245.....	203	442260.....	202	442288.....	214
442295.....	195	442502.....	139	442510.....	136	442512.....	136
442515.....	141	442525.....	140	442560.....	121	442576.....	140
443100.....	151	443120.....	152	443480.....	507	443480.....	1111
443500.....	73	443502.....	73	443505.....	73	443507.....	73
443508.....	73	443510.....	73	443512.....	73	443610.....	507
447025.....	36						





462120	117	465150	34	476206	69	488350	227
462121	117	465155	34	476210	69	488360	220
462148	129	465160	34	476215	69	488361	220
462149	129	465165	34	476220	69	488370	222
462150	129	465170	34	476225	69	488390	224
462151	129	466150	39	476250	69	488395	224
462201	131	466151	38	476255	69	496105	80
462530	131	466160	40	476260	69	496110	80
462530	671	466170	41	476265	69	496111	80
462540	143	466200	36	476270	69	496112	86
462541	143	466210	36	476275	69	496215	86
462550	143	466211	36	476300	58	496216	86
462600	135	466220	37	476310	58	496217	86
462605	135	466225	37	476330	58		
462632	136	466225	547	476340	58		
462633	136	467100	42	477090	83		
462640	135	467105	42	477091	82		
462641	135	467110	42	477092	82		
462680	142	467115	42	477093	82		
462681	142	467120	42	477108	82		
462690	142	467125	42	477109	59		
462691	142	468190	50	477110	59		
463810	103	468220	47	477112	59		
463820	105	468230	47	477113	59		
463830	103	468240	47	477115	299		
463840	104	471100	338	477116	59		
463885	101	471105	338	477117	59		
463900	148	471115	338	477118	59		
463901	148	471120	338	477170	61		
463903	148	471125	338	477190	56		
463910	148	471130	338	477191	56		
463911	148	471135	338	480100	203		
463912	148	471140	338	480105	204		
463913	148	471175	326	480125	207		
463915	148	471185	326	480126	207		
463920	149	471210	326	480140	206		
463921	149	471215	326	480145	206		
463930	149	475080	63	480150	204		
463932	149	475082	63	480170	205		
463941	148	475084	62	480172	205		
463950	145	475086	62	480195	213		
464220	136	475100	62	480196	213		
464500	114	475101	62	481175	186		
464502	114	475102	62	481180	189		
464600	116	475130	64	481220	196, 745		
464605	116	475131	64	481230	197, 745		
464610	116	475200	70	481231	197, 745		
464615	116	475201	70	481250	199		
464700	126	475210	65	481390	195		
464701	126	475211	65	481500	198		
464705	126	475250	99	481520	197		
464706	126	475305	59	481530	199		
464707	125	475306	59	481610	198		
464710	126	475307	59	481616	212		
464711	126	475308	60	481617	212		
464712	125	475309	60	481618	212		
464715	126	475310	61	481629	212		
464716	126	475311	61	481825	209		
464718	125	475312	61	481826	209		
464720	126	475313	61	481827	209		
464721	126	476105	67	482350	211		
464722	125	476106	67	482370	210		
464725	126	476110	67	482371	210		
464726	126	476115	67	485205	235		
464727	125	476120	67	485210	235		
464800	129	476125	67	485220	235		
464801	129	476150	67	485225	236		
464810	138	476155	67	485262	236		
465100	34	476156	67	485265	237		
465105	34	476160	67	485270	237		
465110	34	476165	67	485450	234		
465115	34	476170	67	486100	234		
465120	34	476175	67	488210	217		
465125	34	476200	69	488305	219		
465130	34	476205	69	488306	219		

## 5

50000	1166
50024	1166
50035	1166
500310	88
500311	88
500312	88
500316	88
500399	90
500400	90
500402	90
500410	91
500412	91
501500	534
501550	534
501552	534
501554	534
501556	534
501558	534
501560	534
501580	534
501648	534
501650	534
501652	534
501654	534
501656	534
501658	534
501660	534
501810	534
501814	534
501820	534
501824	534
501830	534
502002	534
502004	534
502010	534
502012	534
502020	534
502022	534
502030	534
502031	534
502032	534
502033	534
502040	534
502045	534
502060	534
502080	534
502082	534
502084	534
502086	534
502090	534
502100	534
502108	534
502109	534
502110	534
502200	534
502203	534
502245	47
502248	413, 77



502260.....	411	502819.....	536	505140.....	453	506463.....	425
502261.....	411	503500.....	536	505142.....	453	506465.....	425
502262.....	412	503502.....	536	505144.....	453	506470.....	426
502265.....	412	503505.....	536	505146.....	453	506471.....	426
502275.....	389	503525.....	536	505148.....	453	506472.....	426
502276.....	389	503527.....	536	505150.....	453	506475.....	426
502300.....	534	503533.....	536	505152.....	453	506476.....	426
502301.....	534	503539.....	536	505160.....	451	506477.....	426
502302.....	534	503541.....	536	505162.....	451	506478.....	426
502500.....	534	503550.....	536	505166.....	451	506479.....	426
502502.....	534	503552.....	536	505168.....	451	506485.....	419
502504.....	534	503554.....	536	505195.....	418	506490.....	428
502506.....	535	503556.....	536	505196.....	418	506663.....	429
502508.....	535	503558.....	536	505230.....	418, 777	506664.....	429
502510.....	535	503560.....	536	505313.....	452	506665.....	429
502512.....	535	503562.....	536	505334.....	452	506666.....	429
502514.....	535	503564.....	536	505342.....	417	506667.....	429
502516.....	535	503600P.....	536	505400.....	454, 776	506668.....	429
502525.....	535	503602.....	536	505402.....	454	506669.....	429
502527.....	535	503604.....	536	505403.....	454	506672.....	427
502532.....	535	503606.....	536	505404.....	454	506673.....	429
502534.....	535	503608.....	536	505406.....	454	506679.....	427
502536.....	535	503610P.....	536	505414.....	454	506680.....	428
502538.....	535	503612.....	536	505415.....	454	506705.....	24, 434
502540.....	441	503614.....	536	505420.....	454, 776	506705.....	533
502550.....	535	503625.....	536	505422.....	454	506707.....	434
502562.....	414	503627.....	536	505432.....	454	506737.....	779
502566.....	414	503629.....	536	505433.....	454	506742.....	779
502574.....	414	503631.....	536	505450.....	455	506743.....	779
502594.....	415	503633.....	536	505455.....	455	506744.....	779
502599.....	415	503635.....	536	505456.....	455	506746.....	779
502600.....	415, 535	503650.....	536	505462.....	455	506747.....	418
502602.....	535	503652.....	536	505463.....	455	506747.....	778
502604.....	535	503654.....	536	505515.....	458	506748.....	777
502606.....	535	503656.....	536	505605.....	427	506749.....	779
502608.....	535	503658.....	536	505650.....	460	506750.....	434
502620.....	535	503660P.....	536	505654.....	460	506751.....	434
502622.....	535	503675.....	536	505662.....	460	506752.....	434
502624.....	535	503676.....	536	505670.....	460	506802.....	421
502626.....	535	503677.....	536	505674.....	460	506802.....	422
502630.....	535	504075.....	309, 435	505680.....	460	506804.....	422
502632.....	535	504171.....	66	505682.....	460	506806.....	422
502634.....	535	504180.....	57	505686.....	460	506808.....	422
502636.....	535	504181.....	57	505690.....	460	506810.....	422
502640.....	535	504190.....	81	506000.....	457	506812.....	422
502641.....	535	505005.....	459	506003.....	457	506814.....	422
502642.....	535	505010.....	459	506004.....	457	506816.....	422
502643.....	535	505014.....	459	506008.....	457	506818.....	422
502644.....	535	505016.....	459	506016.....	457	506820.....	422
502645.....	535	505018.....	459	506017.....	457	506822.....	422
502646.....	535	505020.....	459	506053.....	457	506824.....	422
502647.....	535	505022.....	459	506060.....	456	506830.....	423
502650.....	535	505028.....	459	506063.....	456	506832.....	423
502651.....	535	505030.....	459	506070.....	456	506842.....	423
502652.....	535	505032.....	459	506075.....	456	506844.....	423
502653.....	535	505046.....	459	506076.....	456	506856.....	420
502654.....	535	505048.....	459	50613AC.....	464	506858.....	420
502655.....	535	505050.....	459	50614AC.....	464	506860.....	420
502656.....	535	505056.....	459	50615AC.....	464	506862.....	420
502657.....	535	505100.....	416	506150.....	455	506864.....	420
502658.....	535	505100.....	776	506152.....	455	506870.....	424
502659.....	535	505102.....	416	506155.....	458	506872.....	424
502750.....	535	505104.....	416, 776	506157.....	458	506874.....	424
502752.....	535	505106.....	416	50616AC.....	464	506880.....	423
502754.....	535	505110.....	417, 777	506220.....	456	506882.....	423
502756.....	535	505112.....	417, 777	506232.....	456	506884.....	423
502758.....	535	505113.....	453	506251.....	456	506888.....	423
502765.....	535	505114.....	417, 777	506252.....	456	506890.....	421
502767.....	536	505116.....	417, 777	506330.....	455	506890.....	424
502800.....	536	505123.....	453	506331.....	455	506950.....	
502802.....	536	505130.....	453	50640.....	1166	506952.....	
502804.....	536	505132.....	453	506455.....	425	507010.....	
502808.....	536	505134.....	453	506460.....	425	507011.....	
502815.....	536	505136.....	453	506461.....	425	507012.....	
502817.....	536	505138.....	453	506462.....	425	507013.....	



507014	462	507615	465	508612	290	511134	160
507015	462	507807	467	508614	290	511134P	474
507020	462	507808	467	508694	290	511135	160
507023	462	507809	467	508696	290	511135P	474
507027	462	507810	467	509004	430	511138	160
507028	462	507812	467	509005	430	511139	160
507030	419	507814	467	509006	430	511139P	474
507031	461	507816	467	509007	430	511140	474
507032	461	507818	467	509008	430	511144	474
507033	461	507820	467	509009	430	511145P	474
507034	461	507822	467	509010	430	511149	474
507035	461	507824	467	509012	431	511250	166
507040	461	507826	467	509013	431	511251	166
507041	461	507828	467	509014	431	511252	167
507045	419, 775	507830	467	509201	433	511635	483
507046	419, 462	507832	467	509202	433	511725	481
507046	775	507834	467	509203	433	511729	481
507048	462	507836	467	509204	289, 433	511730	481
507050	461	507838	467	509205	433	511734	481
507051	461	507840	467	509206	433	511735	481
507052	461	507842	467	509207	434	511739	481
507055	461	507875	467	509209	289	511740	481
507057	461	507876	467	509214	430	511744	481
507060	461	507877	467	509215	430	511745	481
507065	461	507920	466	509216	430	511749	481
507120	428	507922	466	509301	408, 432	511930	482
507121	428	507924	466	509302	408, 432	511940	482
507122	428	507926	466	509304	408, 432	511945	482
507267S	436	507928	466	509305	408, 432	511955	482
507335	435, 766	507930	466	510100	164	512205	482
507336	435, 767	507932	466	510101	164	512780	487
507375	416	507934	466	510110	164	512782	487
507434	435	507936	466	510111	164	512784	487
507453	775	507938	466	510120	164	514375	489
507454	775	507940	466	510121	164	514376	489
507485S	436	507942	466	510130	164	514377	489
507498S	436	507944	466	510131	164	514380	489
507500	468	507946	466	510140	164	514412	204, 490
507501	468	507948	466	510151	165	514413	190, 490
507502	468	507950	466	510161	165	514414	191, 490
507503	468	507952	466	510181	150	514430	192, 491
507504	468	507954	466	510201	162	514431	192, 491
507505	468	507956	466	510211	162	514433	192, 491
507506	468	507958	466	510221	167	514435	192, 491
507507	468	507960	466	510241	162	514436	192, 491
507508	468	508000	466	510250	172	514437	192, 491
507509	468	508002	324, 410	510251	162	514438	192, 491
507510	468	508004	324, 410	510311	154	514480	79
507511	468	508200	436, 524	510312	154	515105	484
507512	468	508201	436, 524	510321	157	515106	484
507513	468	508202	436, 524	510325	156	515110	484
507514	468	508203	436, 524	510335	155	515115	484
507515	468	508204	436, 524	510395	155	515116	484
507516	468	508205	436, 524	510400	161	515120	484
507517	468	508206	436, 524	510405	161	515121	484
507595	465	508207	436, 524	510410	161	515125	484
507596	465	508208	436, 524	510415	161	515126	484
507597	465	508209	436, 524	510420	161	516270	485
507598	465	508230	428	510430	161	516275	485
507599	465	508540	445, 492	510440	158	516280	485
507600	465	508541	445, 492	510441	158	516285	485
507601	465	508542	445, 492	510445	158	516390	486
507602	465	508543	445, 492	510467	168	516400	486
507603	465	508544	445, 492	510469	168	516430	486
507604	465	508545	492	511101	165	518010	471
507605	465	508546	492	511102	165	518015	471
507606	465	508547	492	511110	166	518020	471
507607	465	508548	492	511112	166	518025	471
507608	465	508590	457	511115	160	518025A	475
507609	465	508600	288	511125	474	518025	47
507610	465	508601	288	511130	160	518029	47
507611	465	508602	289	511130P	474	518029A	47
507612	465	508605	288	511131	160	518030	47
507613	465	508606	288	511132	160	518030A	47
507614	465	508610	290	511133	160	518030	47





518034	471	519025	485	522250	538	523109	384
518034A	475	519030	485	522255	538	523110	384
518035	471	520120	111	522260	538	523111	384
518035A	475	520130	111	522261	538	523120	381, 384
518035	476	520135	109	522262	538	523121	384
518039	471	520140	109	522263	538	523121T	381
518039A	475	520150	110	522264	538	523120P	440
518040	471	520152	110	522265	538	523130	382, 384
518040A	475	521185	324	522266	538	523130P	440
518040	476	521186	324	522267	538	523135	384
518044	471	521187	324	522268	538	523140	384
518045	471	521450	389, 536	522269	539	523140P	440
518049	471	521455	389, 536	522270	539	523150	384
518050	471	521460	389, 537	522271	539	523150P	440
518055	471	521465	389, 537	522272	539	523151	384
518085	477	521500	390, 537	522273	539	523160	384
518100	478	521550	391, 537	522274	539	523160P	440
518115	478	521552	391, 537	522275	539	523165	384
518120	478	521554	391, 537	522276	539	523166	384
518125	478	521556	391, 537	522280	539	523167	384
518129	478	521558	391, 537	522290	404, 539	523168	384
518130	478	521820	392, 537	522291	405, 539	523170	384
518134	478	521824	392, 537	522292	404, 539	523175	384
518135	478	522000	537	522293	539	523177	384
518139	478	522001	537	522294	539	523178	384
518140	478	522002	393, 537	522295	539	523180	384
518144	478	522004	393, 537	522296	539	523210P	440
518145	478	522010	393, 537	522297	539	523300	384
518149	478	522012	393, 537	522300P	539, 774	523335	384
518150	478	522020	537	522301	539, 774	523360	384
518155	478	522022	537	522302	539, 774	523370	384
518215	473	522030	394, 537	522305P	539	523400	384
518220	473	522032	394, 537	522306	539, 774	523435	384
518225	473	522040	393, 537	522310P	539	523460	384
518230	473	522045	393, 537	522311	539, 774	523470	384
518235	473	522045	394, 537	522401	539	523505	450
518240	473	522190	403, 537	522402	539	523540	384
518245	473	522191	403, 537	522403	539	523550	384
518250	473	522193	537	522404	539	523551	384
518315	479	522194	409, 537	522408	539	523570	448
518320	479	522195	409	522412	539	523571	448
518325	479	522200P	537	522500	539	523572	448
518330	479	522202	537	522502	539	523573	448
518335	479	522204	537	522504	539	523574	448
518340	479	522205	537	522506	539	523575	448
518426	473	522206	395, 537	522508	539	523577	448
518431	473	522207	537	522510	539	523579	448
518436	473	522208	537	522512	539	523581	448
518441	473	522209	395, 537	522514	539	523582	448
518446	473	522210	537	522516	539	523600	384
518456	474	522215	537	522525	539	523600P	449
518521	480	522216	395, 537	522527	539	523602	449
518526	480	522220	396, 537	522550	439, 539	523604	449
518531	480	522222	396, 538	522552	439	523606	449
518536	480	522224	396, 538	522554	439	523608	449
518541	480	522225P	396, 538	522556	439	523610P	449
518546	480	522226	409, 538	522575	438	523612	449
518556	480	522227	538	522576	438	523614	449
518620	474	522228	400, 538	522577	438	523635	384
518625	474	522229	397, 538	522578	438	523640	447
518630	474	522230	538	522579	438	523642	447
518635	474	522231	538	522580	438	523644	447
518640	474	522232	403, 538	522581	438	523646	447
518720	480	522233	404, 538	522582	438	523648	447
518730	480	522234	538	522583	438	523649	447
518900	472	522235	538	522584	438	523650P	447
518902	472	522236	538	522585	438	523652	447
518904	472	522237	538	522586	438	523654	447
518906	472	522238	538	522587	438	523656	447
518908	472	522240	415	522590	441	523658	447
519000	485	522241	415	522595	441	523660	447
519005	485	522242	406, 538	522596	441	523660P	447
519010	485	522243	538	523100	384	523670	447
519015	485	522244	538	523105	384	523675	447
519020	485	522245	538	523106	384	523677	447



523700.....	384	534202.....	308	640245.....	665	728060.....	1144
523735.....	384	534203.....	308	640260.....	665	728061.....	1144
523760.....	384	534735.....	385	640280.....	130	728062.....	1144
523770.....	384	534737.....	385	640280.....	670	728063.....	1144
523800.....	384	534835.....	385	640524.....	46	728064.....	1144
523835.....	384	534837.....	385	654180.....	882	728065.....	1145
523860.....	384	536100.....	243	654181.....	882	728066.....	1145
523870.....	384	536103.....	243	654190.....	883	728067.....	1145
524010.....	443	536104.....	243	654191.....	883	728068.....	1145
524012.....	443	536105.....	243	658500.....	367	728069.....	1145
524022.....	443	536107.....	244	658505.....	367	728070.....	1145
524036.....	442	536220.....	246			728071.....	1145
524037.....	442	536220.....	765			728072.....	1145
524038.....	442	536275.....	26			728073.....	1145
524039.....	442	537061.....	381			728074.....	1145
524040.....	442	537081.....	381			728075.....	1145
524041.....	442	540111.....	57			728076.....	1145
524042.....	443	540140.....	66			728077.....	1135
524044.....	443	540150.....	81			728078.....	1146
524045.....	443	541094.....	88			728079.....	1139
524050.....	443	541100.....	88			728080.....	1139
524060.....	409	541120.....	88			728081.....	1135
524230.....	189	543965.....	375			728082.....	1138
525150.....	215	544113.....	377			728090.....	1138
525215.....	215	544114.....	377			728091.....	1138
527800.....	401	544115.....	377			728092.....	1145
527805.....	401	544121.....	377			728093.....	1145
527820.....	401	544121L.....	377			728094.....	1145
527825.....	401	544121T.....	377			728095.....	1146
527830.....	401	544123.....	377			728096.....	1135
527835.....	401	544124.....	377			728097.....	1139
527850.....	401	544130.....	377			728098.....	1141
527853.....	401	544130L.....	377			728099.....	1141
527860.....	401	544130T.....	377			728100.....	1141
527862.....	401	544170.....	377			728101.....	1141
527863.....	401	544171.....	377			728102.....	1141
527867.....	409	544172.....	377			728103.....	1141
528135.....	1169	544179.....	375			728104.....	1147
528235.....	1169	544180.....	375			728105.....	1147
529235.....	1169	544181.....	377			728106.....	1147
533105.....	385	544182.....	377			728107.....	1147
533106.....	385	544191.....	377			728108.....	1147
533108.....	385	544192.....	377			728109.....	1147
533109.....	385	544220.....	376			728113.....	1151
533110.....	385	544230.....	376			728114.....	1151
533111.....	385	544240.....	375			728115.....	1151
533140.....	385	544250.....	376			728116.....	1151
533150.....	385	544965.....	375			728117.....	1151
533151.....	385	544965L.....	377			728118.....	1151
533152.....	385	544990.....	377			728119.....	1151
533164.....	385	544990L.....	377			728120.....	1152
533165.....	385	544990T.....	377			728121.....	1152
533166.....	385	544995.....	377			728122.....	1152
533167.....	385	544995L.....	377			728125.....	1152
533168.....	385	544995T.....	375			728126.....	1152
533175.....	385	544500.....	377			728130.....	1152
533177.....	385	550190.....	66			728131.....	1152
533178.....	385	584160.....	985			728132.....	1152
533180.....	385	586240.....	963			728133.....	1152
533181.....	385	586250.....	960			728134.....	1152
533700.....	385	594400.....	883			728135.....	1152
533702.....	385	594402.....	883			728140.....	1151
533735.....	385					728141.....	1151
533737.....	385					728142.....	1151
533800.....	385					728143.....	1151
533802.....	385					728144.....	1151
533835.....	385					728145.....	1151
533837.....	385					728146.....	1153
533860.....	385					728147.....	1152
533862.....	385					728148.....	1151
533870.....	385					728149.....	1151
533872.....	385					728150.....	1151
534140.....	385					728151.....	1151
534150.....	385					728152.....	1151
534201.....	308					728153.....	1151

## 7

720000.....	1149						
720000M.....	327, 1149						
720001.....	1149						
720001M.....	327, 1149						
728000.....	1148						
728001.....	1148						
728002.....	1148						
728003.....	1148						
728004.....	1148						
728005.....	1148						
728006.....	1148						
728007.....	1148						
728008.....	1148						
728009.....	1148						
728010.....	1148						
728011.....	1148						
728012.....	1135						
728013.....	1135						
728014.....	1135						
728015.....	1135						
728016.....	1135						
728017.....	1135						
728020.....	1136						
728021.....	1136						
728022.....	1136						
728023.....	1136						
728024.....	1136						
728025.....	1136						
728026.....	1136						
728027.....	1136						
728028.....	1136						
728029.....	1136						
728030.....	1137						
728031.....	1137						
728032.....	1137						
728033.....	1137						
728034.....	1139						
728035.....	1139						
728036.....	1139						
728037.....	1139						
728038.....	1140						
728039.....	1140						
728040.....	1140						
728041.....	1140						
728042.....	1142						
728043.....	1142						
728044.....	1143						
728045.....	1143						
728046.....	1143						
728047.....	1143						
728050.....	1143						
728051.....	1143						
728052.....	1143						
728053.....	1143						
728054.....	1143						
728055.....	1144						
728056.....	1144						
728057.....	1143						
728058.....	1142						
728059.....	1144						

## 6

616370.....	99						
622700.....	883						
640200.....	670						
640205.....	670						
640210.....	665						
640212.....	665						
640214.....	665						
640216.....	665						
640225.....	665						



728154.....	1151	752397.....	275	841015.....	787	971000.....	370
728155.....	1151	752526.....	269	841016.....	787	971001.....	370
728156.....	1151	754125.....	279	841030.....	786	971002.....	370
728157.....	1151	754160.....	280	841031.....	786	971003.....	370
728158.....	1151	754370.....	282	841032.....	786	971004.....	370
728159.....	1151	762500.....	264	841033.....	786	971005.....	370
728160.....	1151	766520.....	267	841034.....	786	971010.....	371
728161.....	1150	766522.....	267	841050.....	789	979000.....	371
728162.....	1150	770405.....	263	841051.....	789		
728163.....	1150	770730.....	263	841052.....	789		
728164.....	1150	790310.....	112	841100.....	790		
728165.....	1150	790315.....	112	841101.....	790		
728166.....	1150	790320.....	121, 951	841150.....	789		
728167.....	1150			841160.....	788		
728168.....	1150			841161.....	788		
728169.....	1150			841300.....	791		
728170.....	1150			841301.....	791		
728171.....	1150			841302.....	791		
728172.....	1150			841330.....	790		
728173.....	1150			841350.....	792		
728174.....	1150			841351.....	791		
728175.....	1150			841400.....	791		
728176.....	1150			841401.....	790		
728177.....	1150			841951.....	792		
728178.....	1150			850102.....	347		
728179.....	1150			850103.....	344		
728180.....	1150			850110.....	345		
728181.....	1150			850115.....	346		
728182.....	1150			850150.....	345		
728183.....	1150			850155.....	347		
728184.....	1150			850310.....	327		
728185.....	1150			850345.....	325		
728186.....	1150			850350.....	325		
728187.....	1150			850355.....	325		
728190.....	1150			850360.....	325		
728191.....	1150			850500.....	343		
728192.....	1150			850502.....	343		
728195.....	1151			884227.....	291		
728197.....	1151						
728199.....	1151						
728200.....	1134						
730295.....	301						
730296.....	301						
732101.....	305						
740165.....	297						
740166.....	297						
742100.....	269						
742102.....	269						
742104.....	269						
742106.....	269						
742108.....	269						
742110.....	269						
746550.....	292						
746797.....	297						
746798.....	297						
746800.....	295						
752338.....	274						
752347.....	274						
752348.....	274						
752349.....	274						
752351.....	274						
752354.....	274						
752380.....	273						
752381.....	273						
752382.....	273						
752383.....	273						
752384.....	273						
752385.....	273						
752390.....	275						
752391.....	275						
752392.....	275						
752393.....	275						
752394.....	275						
752395.....	275						
752396.....	275						
801886.....	191						
806024.....	324						
806026.....	324						
806034.....	325						
806040.....	325						
806048.....	325						
806050.....	325						
806052.....	325						
806058.....	327						
806060.....	327						
806062.....	327						
806064.....	327						
806066.....	327						
806068.....	326						
806070.....	326						
806072.....	326						
806074.....	326						
806076.....	326						
806078.....	326						
806098.....	324						
806122.....	341						
809267.....	1160						
809300.....	1161						
809315.....	1159						
809316.....	1159						
809317.....	1159						
809318.....	1159						
809319.....	1159						
809335.....	1159						
809337.....	1159						
809338.....	1159						
809339.....	1159						
809504.....	1160						
809562.....	1160						
809564.....	1160						
809600.....	1161						
809610.....	1161						
840100.....	342						
840105.....	342						
840110.....	342						
840111.....	343						
840112.....	343						
840113.....	343						
840114.....	343						
840116.....	342						
840117.....	342						
840118.....	342						
840200.....	340						
840210.....	340						
840215.....	340						
840220.....	342						
840221.....	340						
840222.....	340						
841010.....	787						
841011.....	787						
841012.....	787						
841013.....	787						
841014.....	787						
910110.....	344						
920100.....	368						
920200.....	368						
920300.....	369						
920400.....	369						
930100.....	368						
930200.....	368						
930300.....	369						
930301.....	369						
930400.....	369						
940100.....	368						
940200.....	368						
940300.....	369						
940301.....	369						
940400.....	369						
960364.....	326						
970002.....	370						
970003.....	370						
970008.....	371						
970010.....	370						
970020.....	370						
970030.....	370						
970040.....	371						
970600.....	370						
970601.....	370						
970602.....	370						
970603.....	370						
970604.....	370						
970605.....	370						
970700.....	371						
970701.....	371						
970702.....	371						
970705.....	371						

## 8

## 9

## 10

1037800.....	488
1037801.....	488
1037802.....	488
1037803.....	488
1037804.....	488
1037805.....	488
1037806.....	488
1037807.....	488
1037808.....	488
1037809.....	488
1037810.....	488
1037811.....	488
1037812.....	488
1037813.....	488
1037814.....	488
1037815.....	488
1037816.....	488
1037817.....	488
1037818.....	488
1037819.....	488
1037820.....	488
1037821.....	488
1037822.....	488
1037823.....	488
1037824.....	488
1037825.....	488
1037826.....	488
1037827.....	488
1037828.....	488
1037829.....	488
1037830.....	488
1037831.....	488
1037832.....	488
1037833.....	488
1037834.....	488
1037835.....	488
1037836.....	488
1037837.....	488
1037838.....	488
1037839.....	488

## A

A358AFA.....	463
A358PRA.....	463

## DP

DP-28K.....	762
DP-36K.....	762
DP-40K.....	762
DP-44K.....	762
DP-48K.....	762
DP-52K.....	762
DP-56K.....	762
DP-60K.....	762



**E**

EFX-001 ..... 1168

**G**

GFS-1A ..... 1164

GFS-10A ..... 1164

**K**

K05-01251 ..... 1166

**KM1-2**

KM11202 ..... 102  
 KM28468 ..... 1093  
 KM28492 ..... 1092  
 KM28514 ..... 1093  
 KM29430 ..... 1092  
 KM29434 ..... 1092  
 KM29495 ..... 312  
 KM29496 ..... 312  
 KM29497 ..... 312  
 KM29498 ..... 312  
 KM29499 ..... 312  
 KM29500 ..... 312  
 KM29503 ..... 313  
 KM29505 ..... 313  
 KM29507 ..... 313  
 KM29511 ..... 313  
 KM29512 ..... 313  
 KM29513 ..... 313  
 KM29514 ..... 313  
 KM29515 ..... 313  
 KM29517 ..... 313  
 KM29566 ..... 313  
 KM29580 ..... 314  
 KM29582 ..... 314  
 KM29584 ..... 314  
 KM29592 ..... 314  
 KM29604 ..... 313  
 KM29606 ..... 312  
 KM29620 ..... 986  
 KM29630 ..... 986  
 KM29632 ..... 985

**KM3**

KM31680 ..... 103  
 KM31792 ..... 102  
 KM31804 ..... 102  
 KM31832 ..... 105  
 KM31834 ..... 101  
 KM31836 ..... 102  
 KM34306 ..... 117  
 KM34308 ..... 117  
 KM34310 ..... 117  
 KM34312 ..... 117  
 KM34334 ..... 118  
 KM34336 ..... 118  
 KM34348 ..... 120  
 KM34354 ..... 120  
 KM34356 ..... 120  
 KM34458 ..... 125  
 KM34462 ..... 125  
 KM34472 ..... 125  
 KM34474 ..... 125  
 KM34560 ..... 140  
 KM34562 ..... 140

KM34602 ..... 137  
 KM34607 ..... 137  
 KM34612 ..... 137  
 KM34621 ..... 138  
 KM34642 ..... 121  
 KM34648 ..... 143  
 KM35068 ..... 109  
 KM35078 ..... 107  
 KM35080 ..... 108  
 KM35084 ..... 106  
 KM35092 ..... 109  
 KM35104 ..... 107  
 KM35120 ..... 106  
 KM35200 ..... 112  
 KM35202 ..... 144  
 KM35210 ..... 144  
 KM35212 ..... 144  
 KM35214 ..... 144  
 KM35220 ..... 145  
 KM35250 ..... 145  
 KM35280 ..... 145  
 KM35286 ..... 145  
 KM35292 ..... 145  
 KM35298 ..... 145  
 KM35316 ..... 145  
 KM35322 ..... 145  
 KM35340 ..... 145  
 KM35364 ..... 146  
 KM35370 ..... 146  
 KM35380 ..... 146  
 KM35382 ..... 146  
 KM35392 ..... 146  
 KM35394 ..... 146  
 KM35396 ..... 146  
 KM35406 ..... 146  
 KM35418 ..... 146  
 KM35430 ..... 146  
 KM35450 ..... 147  
 KM35452 ..... 147  
 KM35454 ..... 147  
 KM35460 ..... 147  
 KM35484 ..... 147  
 KM35490 ..... 147  
 KM35494 ..... 147  
 KM35496 ..... 146  
 KM35510 ..... 133  
 KM35515 ..... 133  
 KM36078 ..... 64  
 KM36164 ..... 74  
 KM36165 ..... 74  
 KM36196 ..... 71  
 KM36198 ..... 71  
 KM36360 ..... 69  
 KM36362 ..... 69  
 KM36566 ..... 83  
 KM36816 ..... 298  
 KM36818 ..... 298  
 KM36826 ..... 298  
 KM36828 ..... 298  
 KM38082 ..... 38  
 KM38304 ..... 42  
 KM39050 ..... 44  
 KM39052 ..... 35  
 KM39054 ..... 44  
 KM39056 ..... 44  
 KM39057 ..... 44  
 KM39058 ..... 35  
 KM39059 ..... 35  
 KM39060 ..... 35  
 KM39062 ..... 35  
 KM39064 ..... 44  
 KM39086 ..... 41  
 KM39088 ..... 52  
 KM39364 ..... 32  
 KM39366 ..... 32

KM39386 ..... 32  
 KM39390 ..... 32  
 KM39410 ..... 32  
 KM39412 ..... 32  
 KM39478 ..... 33  
 KM39509 ..... 33  
 KM39511 ..... 33  
 KM39513 ..... 33  
 KM39534 ..... 33  
 KM39536 ..... 33  
 KM39670 ..... 341  
 KM39682 ..... 344  
 KM39684 ..... 344  
 KM39692 ..... 309, 1082  
 KM39694 ..... 309, 1082  
 KM39698 ..... 309, 1082  
 KM39700 ..... 309, 1082

**KM4**

KM41064 ..... 153  
 KM41066 ..... 153  
 KM41068 ..... 158  
 KM41162 ..... 163  
 KM41164 ..... 163  
 KM41270 ..... 165  
 KM41272 ..... 165  
 KM41278 ..... 165  
 KM41284 ..... 165  
 KM41286 ..... 165  
 KM41300 ..... 165  
 KM41424 ..... 159  
 KM41428 ..... 159  
 KM41440 ..... 159  
 KM41452 ..... 159  
 KM42254 ..... 320  
 KM42256 ..... 321  
 KM42258 ..... 321  
 KM42618 ..... 308  
 KM42823 ..... 243  
 KM42824 ..... 243  
 KM42825 ..... 243  
 KM42825P ..... 243  
 KM42826 ..... 243  
 KM42830 ..... 243  
 KM42863 ..... 244  
 KM42864 ..... 244  
 KM42866 ..... 244  
 KM42873 ..... 244  
 KM42874 ..... 244  
 KM42876 ..... 244  
 KM42880 ..... 246  
 KM42881 ..... 246  
 KM42882 ..... 246  
 KM42883 ..... 246  
 KM42884 ..... 246  
 KM42885 ..... 246  
 KM42890 ..... 246  
 KM42891 ..... 246  
 KM42892 ..... 246  
 KM42893 ..... 246  
 KM42894 ..... 246  
 KM42895 ..... 246  
 KM42901 ..... 246  
 KM42902 ..... 246  
 KM42903 ..... 246  
 KM42904 ..... 246  
 KM42905 ..... 246  
 KM42906 ..... 246  
 KM44012 ..... 1106  
 KM44014 ..... 1107  
 KM44018 ..... 1117  
 KM44020 ..... 1117  
 KM44022 ..... 1113  
 KM44024 ..... 1116  
 KM44028 ..... 319  
 KM44030 ..... 319  
 KM44031 ..... 321  
 KM44121 ..... 181  
 KM44122 ..... 181  
 KM44123 ..... 181  
 KM44124 ..... 181  
 KM44125 ..... 181  
 KM44126 ..... 181  
 KM44127 ..... 181  
 KM44128 ..... 181  
 KM44129 ..... 181  
 KM44130 ..... 181  
 KM44131 ..... 181  
 KM44132 ..... 181  
 KM44133 ..... 181  
 KM44134 ..... 181  
 KM44135 ..... 181  
 KM44136 ..... 181  
 KM44137 ..... 181  
 KM44138 ..... 181  
 KM44139 ..... 181  
 KM44150 ..... 181  
 KM44151 ..... 181  
 KM44152 ..... 181  
 KM44153 ..... 181  
 KM44154 ..... 181  
 KM44155 ..... 175  
 KM44156 ..... 175  
 KM44157 ..... 175  
 KM44158 ..... 175  
 KM44159 ..... 180  
 KM44160 ..... 180  
 KM44161 ..... 180  
 KM44162 ..... 180  
 KM44163 ..... 175  
 KM44164 ..... 175  
 KM44165 ..... 175  
 KM44166 ..... 175  
 KM44167 ..... 175  
 KM44168 ..... 175  
 KM44169 ..... 175  
 KM44170 ..... 175  
 KM44171 ..... 180  
 KM44172 ..... 180  
 KM44173 ..... 180  
 KM44174 ..... 180  
 KM44175 ..... 180  
 KM44176 ..... 180  
 KM44177 ..... 180  
 KM44178 ..... 180  
 KM44200 ..... 176  
 KM44201 ..... 176  
 KM44202 ..... 176  
 KM44203 ..... 176  
 KM44204 ..... 176  
 KM44205 ..... 176  
 KM44207 ..... 176  
 KM44208 ..... 176  
 KM44210 ..... 177  
 KM44211 ..... 177  
 KM44212 ..... 177  
 KM44213 ..... 177  
 KM44214 ..... 176  
 KM44215 ..... 176  
 KM44216 ..... 177  
 KM44217 ..... 177  
 KM44218 ..... 177  
 KM44219 ..... 17  
 KM44220 ..... 17  
 KM44221 ..... 17  
 KM44222 ..... 17  
 KM44223 ..... 17  
 KM44250 ..... 11'



KM44251 .....	1113	KM46266 .....	960	KM46393 .....	1007	KM46467 .....	1006
KM44252 .....	1113	KM46268 .....	996	KM46394 .....	1007	KM46468 .....	1006
KM44253 .....	1113	KM46270 .....	996	KM46395 .....	1007	KM46476 .....	1006
KM44254 .....	1117	KM46272 .....	996	KM46401 .....	1007	KM46477 .....	1006
KM44255 .....	1117	KM46274 .....	996	KM46402 .....	1007	KM46478 .....	1006
KM44256 .....	1117	KM46276 .....	996	KM46403 .....	1007	KM46479 .....	1006
KM44257 .....	1117	KM46278 .....	996	KM46404 .....	1007	KM46487 .....	1006
KM44260 .....	1114	KM46280 .....	996	KM46405 .....	1007	KM46488 .....	1006
KM44261 .....	1114	KM46284 .....	997	KM46407 .....	1007	KM46489 .....	1006
KM44262 .....	1114	KM46286 .....	997	KM46408 .....	1007	KM46490 .....	1006
KM44263 .....	1114	KM46288 .....	997	KM46409 .....	1007	KM46491 .....	1006
KM44270 .....	1115	KM46289 .....	1002	KM46410 .....	1007	KM46493 .....	1006
KM44271 .....	1115	KM46290 .....	1002	KM46411 .....	1007	KM46495 .....	1006
KM44272 .....	1115	KM46291 .....	1002	KM46412 .....	1007	KM46497 .....	995
KM44273 .....	1115	KM46292 .....	1005	KM46413 .....	966	KM46498 .....	995
KM44274 .....	1115	KM46293 .....	1005	KM46413S .....	967	KM46499 .....	995
KM44275 .....	1115	KM46294 .....	1005	KM46414 .....	966	KM46500 .....	995
KM44276 .....	1115	KM46304 .....	994	KM46414S .....	967	KM46501 .....	995
KM44277 .....	1115	KM46306 .....	994	KM46416 .....	966	KM46502 .....	995
KM45002 .....	856	KM46310 .....	994	KM46416S .....	967	KM46503 .....	995
KM45004 .....	873	KM46314 .....	994	KM46418 .....	966	KM46504 .....	995
KM45122 .....	881	KM46318 .....	994	KM46418S .....	967	KM46505 .....	1003
KM45126 .....	881	KM46322 .....	994	KM46420 .....	966	KM46506 .....	1003
KM45127 .....	881	KM46328 .....	994	KM46420S .....	967	KM46507 .....	1003
KM45128 .....	881	KM46329 .....	994	KM46422 .....	982	KM46508 .....	1003
KM45208 .....	876	KM46330 .....	994	KM46422S .....	983	KM46509 .....	1003
KM45210 .....	876	KM46331 .....	994	KM46423 .....	982	KM46511 .....	979
KM45300 .....	933	KM46332 .....	994	KM46423S .....	983	KM46512 .....	979
KM45302 .....	919	KM46333 .....	994	KM46424 .....	982	KM46513 .....	979
KM45304 .....	919	KM46335 .....	992	KM46424S .....	983	KM46515 .....	979
KM45305 .....	920	KM46336 .....	992	KM46425 .....	982	KM46517 .....	979
KM45306 .....	920	KM46338 .....	992	KM46425S .....	983	KM46519 .....	979
KM45307 .....	920	KM46340 .....	992	KM46426 .....	982	KM46521 .....	979
KM45310 .....	936	KM46342 .....	992	KM46426S .....	983	KM46523 .....	979
KM45312 .....	936	KM46343 .....	992	KM46427 .....	982	KM46525 .....	979
KM45314 .....	936	KM46344 .....	992	KM46427S .....	983	KM46529 .....	979
KM45410 .....	847	KM46345 .....	992	KM46428 .....	982	KM46531 .....	979
KM45412 .....	847	KM46346 .....	992	KM46428S .....	983	KM46540 .....	812
KM45501 .....	880	KM46347 .....	992	KM46429 .....	982	KM46550 .....	986
KM45502 .....	880	KM46348 .....	993	KM46429S .....	983	KM46551 .....	981
KM46056 .....	1081	KM46349 .....	993	KM46430 .....	982	KM46552 .....	981
KM46058 .....	1080	KM46350 .....	993	KM46430S .....	983	KM46553 .....	981
KM46090 .....	1078	KM46351 .....	993	KM46433 .....	982	KM46554 .....	981
KM46133 .....	1080	KM46352 .....	993	KM46433S .....	983	KM46555 .....	981
KM46134 .....	1080	KM46353 .....	993	KM46434 .....	982	KM46556 .....	981
KM46138 .....	1079	KM46354 .....	993	KM46434S .....	983	KM46557 .....	981
KM46156 .....	1078	KM46355 .....	993	KM46435 .....	982	KM46558 .....	981
KM46184 .....	1079	KM46356 .....	993	KM46435S .....	983	KM46559 .....	981
KM46186 .....	1079	KM46358 .....	993	KM46436 .....	982	KM46560 .....	987
KM46188 .....	1078	KM46359 .....	998	KM46436S .....	983	KM46561 .....	987
KM46206 .....	964	KM46360 .....	998	KM46437 .....	982	KM46562 .....	987
KM46207 .....	964	KM46361 .....	998	KM46437S .....	983	KM46563 .....	979
KM46208 .....	962	KM46362 .....	998	KM46438 .....	982	KM46564 .....	979
KM46210 .....	962	KM46363 .....	998	KM46438S .....	983	KM46565 .....	979
KM46211 .....	964	KM46364 .....	998	KM46439 .....	982	KM46566 .....	979
KM46212 .....	964	KM46365 .....	998	KM46439S .....	983	KM46567 .....	979
KM46213 .....	964	KM46366 .....	998	KM46440 .....	982	KM46568 .....	979
KM46214 .....	964	KM46367 .....	998	KM46440S .....	983	KM46569 .....	979
KM46215 .....	965	KM46368 .....	998	KM46441 .....	982	KM46570 .....	979
KM46216 .....	965	KM46373 .....	998	KM46441S .....	983	KM46571 .....	979
KM46217 .....	965	KM46376 .....	998	KM46448 .....	999	KM46572 .....	815, 841
KM46222 .....	962	KM46377 .....	998	KM46449 .....	999	KM46573 .....	815, 841
KM46224 .....	962	KM46378 .....	998	KM46450 .....	999	KM46574 .....	815, 841
KM46244 .....	962	KM46379 .....	998	KM46451 .....	999	KM46578 .....	838
KM46245 .....	962	KM46380 .....	998	KM46452 .....	999	KM46582 .....	819
KM46246 .....	962	KM46381 .....	998	KM46453 .....	999	KM46598 .....	1077
KM46248 .....	962	KM46382 .....	998	KM46454 .....	999	KM46600 .....	1077
KM46250 .....	969	KM46383 .....	998	KM46457 .....	999	KM46601 .....	1076
KM46252 .....	969	KM46384 .....	998	KM46458 .....	999	KM46602 .....	1077
KM46254 .....	969	KM46387 .....	1007	KM46459 .....	999	KM46609 .....	
KM46256 .....	969	KM46388 .....	1007	KM46460 .....	999	KM46610 .....	
KM46258 .....	960	KM46389 .....	1007	KM46461 .....	999	KM46612 .....	
KM46260 .....	960	KM46390 .....	1007	KM46462 .....	999	KM46613 .....	
KM46262 .....	960	KM46391 .....	1007	KM46463 .....	999	KM46614 .....	
KM46264 .....	960	KM46392 .....	1007	KM46466 .....	1006	KM46615 .....	





KM46616.....	1075	KM46762.....	950	KM47084.....	927	KM47275.....	1023
KM46617.....	1075	KM46766.....	950	KM47090.....	930	KM47276.....	1030
KM46619.....	817	KM46770.....	950	KM47092.....	930	KM47278.....	1032
KM46620.....	1076	KM46772.....	950	KM47094.....	930	KM47284.....	1032
KM46621.....	824	KM46802.....	946	KM47096.....	930	KM47285.....	1030
KM46622.....	823	KM46804.....	947	KM47098.....	930	KM47286.....	1027
KM46623.....	825	KM46814.....	946	KM47100.....	937	KM47296.....	1024
KM46624.....	825	KM46818.....	946	KM47101.....	937	KM47302.....	1031
KM46625.....	826	KM46821.....	951	KM47102.....	938	KM47304.....	1031
KM46626.....	830	KM46823.....	895	KM47103.....	938	KM47306.....	1031
KM46629.....	829	KM46826.....	897	KM47105.....	935	KM47308.....	1028
KM46631.....	826	KM46827.....	898	KM47107.....	935	KM47310.....	1026
KM46631.....	815	KM46828.....	951	KM47108.....	928	KM47366.....	1021
KM46632.....	829	KM46829.....	895	KM47109.....	928	KM47370.....	1021
KM46633.....	829	KM46830.....	895	KM47110.....	928	KM47374.....	1022
KM46635.....	833	KM46832.....	895	KM47112.....	928	KM47380.....	1044
KM46637.....	818	KM46836.....	896	KM47114.....	928	KM47382.....	1044
KM46642.....	1077	KM46838.....	896	KM47116.....	928	KM47384.....	1044
KM46643.....	1077	KM46841.....	897	KM47118.....	929	KM47386.....	1044
KM46644.....	1077	KM46842.....	897	KM47119.....	931	KM47398.....	1020
KM46645.....	1076	KM46848.....	896	KM47120.....	930	KM47400.....	1020
KM46646.....	1076	KM46849.....	898	KM47122.....	931	KM47402.....	1020
KM46647.....	827	KM46850.....	897	KM47124.....	931	KM47404.....	1020
KM46649.....	828	KM46852.....	898	KM47126.....	931	KM47406.....	1020
KM46650.....	973	KM46854.....	898	KM47128.....	935	KM47408.....	1020
KM46651.....	828	KM46858.....	896	KM47129.....	921	KM47410.....	1020
KM46652.....	973	KM46860.....	892	KM47130.....	918	KM47412.....	1020
KM46653.....	976	KM46870.....	892	KM47132.....	932	KM47458.....	1043
KM46654.....	973	KM46872.....	891	KM47133.....	934	KM47460.....	1043
KM46655.....	975	KM46880.....	889	KM47134.....	933	KM47461.....	1043
KM46656.....	1012	KM46884.....	889	KM47135.....	934	KM47462.....	1043
KM46657.....	1014	KM46892.....	890	KM47136.....	932	KM47464.....	1043
KM46658.....	1017	KM46893.....	1009	KM47137.....	932	KM47472.....	1042
KM46660.....	1012	KM46894.....	1009	KM47138.....	922	KM47473.....	1042
KM46661.....	1014	KM46895.....	1009	KM47139.....	923	KM47474.....	1038
KM46662.....	1012	KM46896.....	1009	KM47140.....	939	KM47476.....	1038
KM46662P.....	1012	KM46897.....	1009	KM47141.....	939	KM47478.....	1038
KM46663.....	1017	KM46898.....	1009	KM47154.....	939	KM47480.....	1041
KM46664.....	877	KM46899.....	1009	KM47156.....	939	KM47482.....	1041
KM46666.....	1016	KM46902.....	968	KM47160.....	940	KM47484.....	1041
KM46667.....	1017	KM46903.....	968	KM47164.....	940	KM47486.....	1039
KM46683.....	1076	KM46904.....	968	KM47166.....	940	KM47488.....	1039
KM46684.....	1076	KM46906.....	891	KM47168.....	939	KM47487.....	1039
KM46685.....	1076	KM46907.....	891	KM47168.....	939	KM47488.....	1039
KM46686.....	1015	KM46908.....	891	KM47170.....	925	KM47489.....	1039
KM46686P.....	1015	KM46911.....	918	KM47172.....	922	KM47490.....	1039
KM46687.....	1015	KM46912.....	918	KM47173.....	922	KM47492.....	1039
KM46687P.....	1015	KM46913.....	945	KM47190.....	925	KM47494.....	1040
KM46688.....	1018	KM46914.....	945	KM47192.....	925	KM47495.....	1040
KM46689.....	1018	KM46915.....	945	KM47194.....	924	KM47496.....	1040
KM46690.....	1018	KM46916.....	944	KM47196.....	924	KM47497.....	1040
KM46690P.....	1018	KM46917.....	849	KM47198.....	925	KM47498.....	1040
KM46700.....	995	KM46918.....	849	KM47200.....	924	KM47499.....	1040
KM46701.....	995	KM46919.....	1006	KM47202.....	939	KM47520.....	1034
KM46702.....	995	KM46920.....	892	KM47204.....	926	KM47522.....	1034
KM46703.....	995	KM46921.....	892	KM47206.....	926	KM47523.....	1035
KM46704.....	995	KM46922.....	903	KM47208.....	926	KM47524.....	1037
KM46705.....	973	KM46923.....	885	KM47212.....	929	KM47525.....	1036
KM46706.....	995	KM46930.....	885	KM47214.....	1024	KM47526.....	1035
KM46708.....	995	KM46932.....	884	KM47242.....	1024	KM47527.....	1035
KM46709.....	995	KM46934.....	888	KM47244.....	1024	KM47528.....	1035
KM46730.....	952	KM46936.....	888	KM47252.....	1023	KM47531.....	1035
KM46731.....	952	KM47010.....	921	KM47253.....	1023	KM47532.....	1035
KM46732.....	952	KM47012.....	923	KM47254.....	1028	KM47533.....	1035
KM46733.....	952	KM47054.....	926	KM47256.....	1028	KM47534.....	1035
KM46734.....	952	KM47056.....	926	KM47258.....	1028	KM47538.....	1022
KM46735.....	949	KM47062.....	926	KM47260.....	1028	KM47540.....	1021
KM46736.....	950	KM47064.....	926	KM47262.....	1025	KM47541.....	1021
KM46737.....	950	KM47068.....	927	KM47263.....	1025	KM47542.....	1022
KM46738.....	950	KM47070.....	927	KM47266.....	1025	KM47546.....	1019
KM46739.....	949	KM47072.....	924	KM47266.....	1029	KM47550.....	102
KM46744.....	948	KM47074.....	923	KM47267.....	1027	KM47553.....	102
KM46746.....	948	KM47076.....	923	KM47268.....	1029	KM47555.....	102
KM46748.....	948	KM47078.....	927	KM47270.....	1019	KM47557.....	102
KM46750.....	947	KM47080.....	927	KM47272.....	1019	KM47558.....	102
		KM47082.....	927	KM47274.....	1023	KM47558.....	102
						KM47560.....	102



KM47562.....	1033	KM47879.....	1055	KM47980.....	863	KM48086.....	858
KM47610.....	1056	KM47880.....	942	KM47981.....	859	KM48091.....	859
KM47612.....	1056	KM47901.....	813	KM47982.....	864	KM48092.....	859
KM47614.....	1056	KM47902.....	856	KM47983.....	869	KM48093.....	859
KM47616.....	1056	KM47903.....	813	KM47985.....	863	KM48094.....	859
KM47620.....	1053	KM47904.....	856	KM47986.....	859	KM48095.....	859
KM47621.....	1053	KM47906.....	1098	KM47987.....	1057	KM48100.....	857
KM47622.....	1053	KM47907.....	1098	KM47988.....	1055	KM48102.....	861
KM47623.....	1053	KM47908.....	856	KM47989.....	1055	KM48104.....	861
KM47624.....	1053	KM47909.....	867	KM47990.....	1055	KM48106.....	862
KM47644.....	1052, 1054	KM47910.....	866	KM47991.....	1055	KM48108.....	862
KM47645.....	1052, 1054	KM47911.....	867	KM47992.....	1055	KM48110.....	862
KM47646.....	1052, 1054	KM47912.....	847	KM47993.....	1055	KM48112.....	862
KM47648.....	1052, 1054	KM47914.....	847	KM47994.....	1055	KM48114.....	862
KM47649.....	1052, 1054	KM47915.....	879	KM47995.....	1055	KM48116.....	861
KM47650.....	1052, 1054	KM47916.....	879	KM47996.....	1055	KM48118.....	861
KM47652.....	1054	KM47917.....	879	KM47997.....	1055	KM48120.....	861
KM47654.....	1054	KM47918.....	879	KM47998.....	1055	KM48122.....	861
KM47656.....	1054	KM47919.....	880	KM47999.....	1055	KM48144.....	857
KM47657.....	1054	KM47920.....	860	KM48-129.....	857	KM48158.....	882
KM47658.....	1054	KM47921.....	1098	KM48-130.....	857	KM48161.....	882
KM47670.....	1051	KM47922.....	860	KM48-132.....	857	KM48192.....	894
KM47671.....	1051	KM47923.....	860	KM48-134.....	857	KM48194.....	894
KM47674.....	1051	KM47924.....	860	KM48-136.....	857	KM48196.....	894
KM47676.....	1051	KM47925.....	846	KM48-137.....	857	KM48198.....	894
KM47678.....	1051	KM47926.....	861	KM48-138.....	857	KM48200.....	894
KM47680.....	1051	KM47927.....	845	KM48-140.....	857	KM48201.....	890
KM47682.....	1051	KM47928.....	845	KM48-142.....	857	KM48202.....	893
KM47685.....	1055	KM47929.....	846	KM48-143.....	857	KM48204.....	893
KM47686.....	1055	KM47930.....	876	KM48002.....	864	KM48206.....	893
KM47687.....	1055	KM47931.....	845	KM48003.....	863	KM48208.....	889
KM47688.....	1055	KM47932.....	831	KM48004.....	863	KM48210.....	889
KM47689.....	1051	KM47934.....	874	KM48010.....	1057	KM48212.....	889
KM47700.....	1063	KM47935.....	874	KM48016.....	1055	KM48214.....	889
KM47702.....	1063	KM47936.....	874	KM48017.....	1055	KM48217.....	910
KM47703.....	1063	KM47940.....	874	KM48018.....	1055	KM48218.....	910
KM47704.....	1063	KM47941.....	881	KM48019.....	1055	KM48220.....	910
KM47707.....	1061	KM47942.....	881	KM48020.....	1055	KM48226.....	911
KM47708.....	1061	KM47943.....	881	KM48021.....	1055	KM48228.....	911
KM47709.....	1061	KM47944.....	881	KM48022.....	1055	KM48230.....	910
KM47710.....	1061	KM47945.....	881	KM48023.....	1055	KM48234.....	884
KM47712.....	1061	KM47946.....	880	KM48024.....	1055	KM48237.....	884
KM47714.....	1061	KM47947.....	880	KM48025.....	1055	KM48239.....	868
KM47730.....	1061	KM47948.....	880	KM48026.....	1055	KM48240.....	868
KM47732.....	1061	KM47950.....	871	KM48027.....	1055	KM48241.....	868
KM47734.....	1061	KM47950B.....	871	KM48028.....	1055	KM48242.....	835
KM47760.....	1061	KM47951.....	869	KM48029.....	1055	KM48243.....	837
KM47762.....	1061	KM47952.....	869	KM48030.....	1059	KM48244.....	844
KM47764.....	1061	KM47954.....	870	KM48032.....	1059	KM48245.....	836
KM47780.....	1061	KM47955.....	869	KM48033.....	1059	KM48246.....	838
KM47782.....	1061	KM47956.....	869	KM48040.....	1056	KM48247.....	310
KM47784.....	1061	KM47957.....	873	KM48041.....	1056	KM48248.....	837
KM47800.....	1062	KM47958.....	873	KM48050.....	858	KM48249.....	917
KM47802.....	1062	KM47959.....	871	KM48051.....	858	KM48250.....	836
KM47804.....	1062	KM47959.....	873	KM48052.....	858	KM48252.....	815, 868
KM47840.....	1062	KM47960.....	856	KM48054.....	858	KM48253.....	835
KM47842.....	1062	KM47961.....	869	KM48057.....	858	KM48254.....	840
KM47844.....	1062	KM47962.....	881	KM48058.....	858	KM48256.....	840
KM47850.....	1059	KM47963.....	881	KM48060.....	858	KM48257.....	839
KM47853.....	1054	KM47964.....	881	KM48061.....	858	KM48258.....	839
KM47855.....	1055	KM47965.....	864	KM48063.....	858	KM48259.....	840
KM47856.....	1055	KM47966.....	864	KM48067.....	858	KM48262.....	840
KM47857.....	1055	KM47967.....	864	KM48068.....	858	KM48269.....	839
KM47858.....	1065	KM47968.....	864	KM48069.....	858	KM48270.....	848
KM47860.....	1065	KM47969.....	866	KM48070.....	858	KM48272.....	848
KM47862.....	1065	KM47970.....	864	KM48071.....	858	KM48274.....	848
KM47864.....	1065	KM47971.....	865	KM48072.....	858	KM48282.....	866
KM47866.....	1065	KM47972.....	864	KM48073.....	858	KM48284.....	866
KM47868.....	1065	KM47973.....	865	KM48076.....	858	KM48288.....	1099
KM47870.....	1065	KM47974.....	865	KM48077.....	858	KM48290.....	
KM47872.....	1065	KM47975.....	866	KM48079.....	858	KM48297.....	
KM47873.....	1065	KM47976.....	864	KM48080.....	858	KM48299.....	
KM47874.....	1065	KM47977.....	863	KM48081.....	858	KM48301.....	
KM47875.....	1065	KM47978.....	863	KM48082.....	858	KM48302.....	
KM47878.....	1065	KM47979.....	859	KM48085.....	858	KM48302.....	



KM48303	943	KM48443	853	KM49066	1003	KM49356	999
KM48310	310, 1084	KM48450	853	KM49067	1003	KM49357	999
KM48313	310, 1082	KM48451	853	KM49068	1003	KM49358	999
KM48314	312, 1083	KM48454	854	KM49073	1003	KM49359	999
KM48315	311, 1083	KM48455	854	KM49074	1003	KM49360	999
KM48320	817	KM48456	854	KM49075	1003	KM49361	999
KM48322	817	KM48457	854	KM49076	1003	KM49362	999
KM48324	817	KM48458	854	KM49077	1003	KM49363	999
KM48326	848	KM48459	854	KM49078	1003	KM49403	988
KM48328	848	KM48460	855	KM49079	1003	KM49404	988
KM48330	848	KM48461	855	KM49080	1003	KM49405	988
KM48331	942	KM48462	855	KM49081	1003	KM49413	988
KM48332	943	KM48463	855	KM49082	1003	KM49414	988
KM48333	942	KM48465	852	KM49084	1007	KM49415	988
KM48334	942	KM48466	852	KM49090	1091	KM49423	988
KM48335	942	KM48467	852	KM49092	1091	KM49424	988
KM48336	943	KM48468	852	KM49093	1091	KM49425	988
KM48337	944	KM48469	852	KM49110	979	KM49433	988
KM48338	944	KM48471	875	KM49111	979	KM49434	988
KM48339	944	KM48473	875	KM49112	979	KM49435	988
KM48340	944	KM48474	875	KM49113	979	KM49450	987
KM48341	944	KM48475	875	KM49114	979	KM49452	987
KM48342	942	KM48476	875	KM49115	979	KM49454	987
KM48343	942	KM48477	875	KM49116	979	KM49456	987
KM48344	942	KM48478	875	KM49117	979	KM49458	987
KM48348	871	KM48478P	875	KM49118	979	KM49460	987
KM48349	869	KM48479	875	KM49120	980	KM49574	984
KM48350	872	KM48480	875	KM49121	980	KM49576	984
KM48352	872	KM48600	843	KM49122	980	KM49578	984
KM48353	870	KM48602	843	KM49123	980	KM49580	984
KM48354	872	KM48604	841	KM49124	980	KM49582	984
KM48355	872	KM48605	842	KM49125	980	KM49584	984
KM48356	872	KM48606	843	KM49126	980	KM49630	1000
KM48358	872	KM48608	843	KM49150	981	KM49632	1000
KM48364	870	KM48610	843	KM49151	981	KM49634	1000
KM48365	869	KM48614	844	KM49152	981	KM49640	1000
KM48368	869	KM48616	844	KM49153	981	KM49644	1000
KM48369	869	KM48620	844	KM49154	981	KM49648	1000
KM48370	814	KM48622	844	KM49155	981	KM49652	1000
KM48372	815	KM48670	872	KM49156	981	KM49656	1000
KM48374	813	KM49002	997	KM49157	981	KM49660	1000
KM48380	848	KM49004	997	KM49158	981	KM49664	1000
KM48382	848	KM49006	997	KM49200	986	KM49668	1000
KM48384	848	KM49008	997	KM49202	986	KM49672	1000
KM48386	849	KM49010	1004	KM49204	986	KM49676	1000
KM48388	849	KM49012	1004	KM49246	1004	KM49680	1000
KM48390	851	KM49014	1004	KM49248	1004	KM49701	878
KM48390P	851	KM49016	1004	KM49250	1004	KM49702	878
KM48392	850	KM49018	1006	KM49252	1004	KM49706	878
KM48392P	850	KM49020	1006	KM49254	1004	KM49724	811
KM48394	852	KM49022	1006	KM49256	1004	KM49734	824
KM48395	874	KM49024	1006	KM49258	1004	KM49735	827
KM48396	870	KM49030	1008	KM49260	1004	KM49736	824
KM48414	875	KM49032	1008	KM49262	1004	KM49738	827
KM48415	850	KM49034	1008	KM49264	1004	KM49740	825
KM48420	850	KM49036	1008	KM49266	1004	KM49740P	825
KM48421	850	KM49040	1002	KM49268	1004	KM49750	1009
KM48422	850	KM49041	1002	KM49310	960	KM49751	1009
KM48423	850	KM49042	1002	KM49311	960	KM49752	1009
KM48425	851	KM49043	1002	KM49312	960	KM49753	1009
KM48426	851	KM49044	1002	KM49313	960	KM49754	1009
KM48427	851	KM49045	1002	KM49320	953	KM49760	1013
KM48428	851	KM49050	1005	KM49322	961	KM49761	1012
KM48429	851	KM49051	1005	KM49324	961	KM49762	1017
KM48431	851	KM49052	1005	KM49326	961	KM49763	1016
KM48433	851	KM49053	1005	KM49340	965	KM49764	1011
KM48434	851	KM49054	1005	KM49342	965	KM49765	1011
KM48435	851	KM49055	1005	KM49344	965	KM49766	1015
KM48436	851	KM49059	1003	KM49346	965	KM49767	1015
KM48438	851	KM49060	1003	KM49350	999	KM49780	87
KM48440	853	KM49061	1003	KM49351	999	KM49781	87
KM48441	853	KM49062	1003	KM49352	999	KM49782	87
KM48442	853	KM49063	1003	KM49353	999	KM49783	87
KM48442	853	KM49064	1003	KM49354	999	KM49800	82
KM48443	853	KM49065	1003	KM49355	999	KM49802	87





KM49810.....	821
KM49812.....	877
KM49830.....	878
KM49831.....	878
KM49832.....	878
KM49848.....	878
KM49850.....	878
KM49910.....	816
KM49920.....	838

## KM5

KM51059.....	888
KM51060.....	888
KM51061.....	888
KM51078.....	887
KM51080.....	887
KM51100.....	886
KM51104.....	886
KM51108.....	886
KM51112.....	886
KM51158.....	887
KM51162.....	887
KM51164.....	887
KM51214.....	213
KM51222.....	211
KM51230.....	207
KM51232.....	207
KM51234.....	207
KM51236.....	207
KM51238.....	207
KM51240.....	207
KM51242.....	207
KM51530.....	199
KM51532.....	199
KM51534.....	199
KM51752.....	214
KM51755.....	214
KM51766.....	214
KM52040.....	186
KM52055.....	188
KM52060.....	188
KM52064.....	188
KM52068.....	188
KM52076.....	203
KM52082.....	192
KM52086.....	192
KM52087.....	192
KM52094.....	206
KM52098.....	191
KM52116.....	200
KM52118.....	200
KM52122.....	200
KM52124.....	200
KM52128.....	200
KM52130.....	200
KM52156.....	188
KM52158.....	188
KM52162.....	188
KM52164.....	188
KM52166.....	188
KM52172.....	188
KM52174.....	185
KM52176.....	185
KM52182.....	185
KM52184.....	185
KM52188.....	185
KM52192.....	185
KM52254.....	194
KM52264.....	194
KM52266.....	194
KM52282.....	195, 887
KM52292.....	194, 886
KM52294.....	194, 886

KM52296.....	194, 886
KM52298.....	194, 886
KM52338.....	194
KM52425.....	899
KM52426.....	900
KM52427.....	900
KM52428.....	900
KM52450.....	1097
KM52458.....	888
KM52460.....	888
KM52470.....	222, 907
KM52472.....	222, 907
KM52474.....	221, 907
KM52476.....	223, 908
KM52484.....	222, 908
KM52486.....	222, 908
KM52488.....	222, 908
KM52490.....	222, 908
KM52492.....	219
KM52494.....	219
KM52498.....	219
KM52542.....	223, 908
KM52544.....	223, 908
KM52546.....	220, 903
KM52548.....	220, 901
KM52602.....	908
KM52702.....	916
KM52704.....	912
KM52704F.....	912
KM52704L.....	912
KM52704S.....	912
KM52705L.....	912
KM52705S.....	912
KM52706L.....	912
KM52706S.....	912
KM52707L.....	912
KM52707S.....	912
KM52708L.....	912
KM52708S.....	912
KM52709L.....	912
KM52709S.....	912
KM52711L.....	912
KM52711S.....	912
KM52765.....	225, 906
KM52768.....	225
KM52769.....	225
KM52771.....	226, 907
KM52776.....	225
KM52778.....	225
KM52782.....	226
KM53042.....	311, 1083
KM53174.....	141
KM53176.....	141
KM53265.....	135, 1120
KM53267.....	135, 1120
KM53316.....	134, 1119
KM53318.....	134, 1119
KM53404.....	1103
KM53408.....	1103
KM53420.....	1103
KM53422.....	1103
KM53426.....	1102
KM53428.....	1102
KM53440.....	1104
KM53460.....	1105
KM53480.....	1111
KM53484.....	1111
KM53560.....	1109
KM53564.....	1110
KM53568.....	1109
KM53574.....	1110
KM53580.....	1109
KM53686.....	1110
KM53688.....	1110
KM53690.....	1110

KM54080.....	1125
KM54108.....	1125
KM54272.....	1127
KM54280.....	1127
KM54282.....	1127
KM54284.....	1127
KM54307.....	1124
KM54309.....	1124
KM54311.....	1124
KM54313.....	1124
KM54330.....	1122
KM54332.....	1122
KM54334.....	1122
KM54338.....	189
KM54342.....	189
KM54346.....	189
KM54348.....	189
KM54366.....	193
KM54368.....	193
KM54372.....	193
KM54668.....	1131
KM55100.....	39
KM55164.....	495
KM55170.....	948
KM55188.....	495
KM55300.....	953
KM55302.....	953
KM55330.....	955
KM55331.....	955
KM55332.....	955
KM55333.....	953
KM55334.....	953
KM55335.....	955
KM55336.....	955
KM55337.....	955
KM55338.....	954
KM55339.....	954
KM55340.....	954
KM55341.....	954
KM55342.....	954
KM55343.....	954
KM55344.....	953
KM55345.....	953
KM55346.....	953
KM55347.....	953
KM55348.....	953
KM55370.....	1010
KM55371.....	1010
KM55372.....	1010
KM55373.....	1010
KM55374.....	1010
KM55375.....	1010
KM55376.....	1010
KM55377.....	1010
KM55378.....	1010
KM55400.....	1016
KM55401.....	1016
KM55410.....	909
KM55412.....	909
KM55420.....	886
KM55421.....	886
KM55422.....	886
KM55424.....	884
KM55426.....	885
KM55428.....	885
KM55430.....	905
KM55431.....	905
KM55432.....	905
KM55438.....	902
KM55440.....	905
KM55441.....	905
KM55445.....	912
KM55446.....	913
KM55447.....	916
KM55448.....	916

KM55449.....	916
KM55450.....	916
KM55451.....	914
KM55452.....	914
KM55453.....	914
KM55454.....	914
KM55455.....	913
KM55456.....	915
KM55457.....	915
KM55458.....	913
KM55459.....	913
KM55460.....	913
KM55461.....	914
KM55462.....	914
KM55463.....	914
KM55464.....	914
KM55465.....	914
KM55466.....	914
KM55467.....	914
KM55468.....	914
KM55469.....	914
KM55471.....	915
KM55472.....	915
KM55473.....	914
KM55474.....	915
KM55475.....	915
KM55476.....	915
KM55480.....	906
KM55481.....	906
KM55482.....	906
KM55483.....	906
KM55484.....	906
KM55485.....	906
KM55486.....	906
KM55487.....	906
KM55488.....	906
KM55490.....	909
KM55495.....	909
KM55496.....	909
KM55497.....	900
KM55498.....	904
KM55499.....	904
KM55510.....	990
KM55523.....	989
KM55532.....	989
KM55533.....	989
KM55543.....	989
KM55556.....	989
KM55573.....	990
KM55586.....	990
KM55593.....	990
KM55610.....	967
KM55612.....	967
KM55614.....	967
KM55620.....	967
KM55630.....	1008
KM55640.....	968
KM55642.....	998
KM55644.....	968
KM55654.....	968
KM55676.....	1010
KM55680.....	988
KM55681.....	988
KM55682.....	988
KM55684.....	988
KM55685.....	988
KM55686.....	988
KM55690.....	1064
KM55691.....	1064
KM55693.....	988
KM55694.....	988
KM55762.....	988
KM55763.....	988
KM55767.....	988



KM55777	1065	KM56330	502	KM64288	284	KM69540	977
KM55782	1058	KM56334	502	KM64796	276	KM69541	977
KM55788	1058	KM57176	498	KM64802	276	KM69542	970
KM55790	1058	KM57614	504, 957	KM64808	277	KM69543	970
KM55798	969	KM57615	504, 957	KM64830	284	KM69544	970
KM55813	1057	KM57616	504, 957	KM65084	268	KM69545	971
KM55815	1057	KM57618	969	KM65115	267	KM69546	971
KM55823	1057	KM57620	959	KM65118	267	KM69547	974
KM55825	1057	KM57622	959	KM65162	266	KM69549	971
KM55842	1060	KM57624	956	KM65186	268	KM69557	1070
KM55856	1064	KM57626	956	KM65188	268	KM69579	1096
KM55858	1060	KM57628	956	KM65204	268	KM69590	1096
KM55860	1060	KM57630	956	KM65205	268	KM69595	1073
KM55870	1054	KM57632	956	KM65490	291	KM69618	1096
KM55871	1054	KM58050	974	KM65492	291	KM69620	1096
KM55872	1054	KM58052	974	KM65494	291	KM69622	1096
KM55891	1050	KM58062	977	KM65496	291	KM69623	1096
KM55892	1050	KM58070	972	KM65498	291	KM69625	1096
KM55895	1050	KM58072	976	KM67164	119	KM69640	1097
KM55898	1050	KM58073	976	KM67166	119	KM69645	1097
KM55901	1050	KM58075	963	KM67168	119	KM69650	1097
KM55904	1050	KM58076	963	KM67170	119	KM69758	958
KM55905	1050	KM58077	882	KM67172	119	KM69760	958
KM55906	1050	KM58083	882	KM67174	119	KM69762	958
KM55908	1050	KM58085	963	KM67292	272	KM69764	958
KM55909	1050	KM58096	1076	KM67294	271	KM69766	958
KM55910	1050	KM58097	1076	KM67498	270	KM69787	920
KM55911	1050	KM58098	1076	KM67500	270	KM69790	1093
KM55912	1050	KM58100	996	KM67509	270	KM69792	1073
KM55913	1050	KM58102	996	KM67511	270	KM69793	1073
KM55914	1050	KM58104	996	KM67516	270	KM69795	940
KM55915	1050	KM58106	978	KM67526	271	KM69805	1074
KM55916	1050	KM58108	978	KM69106	1074	KM69820	104
KM55917	1050	KM58110	978	KM69290	1070	KM69824	104
KM55918	1050	KM58112	978	KM69291	1070	KM69827	941
KM55919	1050	KM58240	901	KM69292	1070	KM69830	868
KM55925	1050	KM58242	901	KM69294	1070	KM69832	868
KM55926	1050	KM59200	1049, 1085	KM69320	1071	KM69834	868
KM55927	1050	KM59300	1049	KM69322	1071	KM69836	868
KM55928	1050	KM59303	1049	KM69326	1071	KM69838	868
KM55929	1050	KM59306	1049	KM69327	1071	KM69840	868
KM55935	1062	KM59309	1049	KM69340	1071	KM69846	820
KM55936	1062	KM59312	1049	KM69341	1071	KM69905	815
KM55937	1062	KM59313	1049	KM69342	1071	KM69930	1072
KM55938	1062	KM59315	1049	KM69343	1071	KM69932	1072
KM55940	1063	KM59316	1049	KM69344	1071	KM69940	993
KM55941	1063	KM59321	1049	KM69348	1072	KM69946	993
KM55942	1063	KM59322	1049	KM69418	1069	KM69950	993
KM55946	1063			KM69430	1069	KM69970	993
KM55947	1063			KM69432	1069	KM69975	993
KM55948	1063			KM69438	1069	KM69980	1009
KM55949	1063			KM69440	1069	KM69982	885
KM55952	1063	KM63300	302	KM69441	1069	KM69990	901
KM55953	1063	KM63318	303	KM69445	1068		
KM55954	1063	KM63319	303	KM69446	1068		
KM55960	1062	KM63350	302	KM69448	1071		
KM55961	1062	KM63352	302	KM69457	1094		
KM55962	1062	KM63354	302	KM69459	1095	KM71431	883
KM55963	1062	KM63503	299	KM69461	1095	KM72220	810
KM55964	1062	KM64006	295	KM69463	1095	KM72222	810
KM55966	1062	KM64008	295	KM69465	1095	KM72224	810
KM55967	1062	KM64010	295	KM69468	1095	KM72226	810
KM55972	1062	KM64012	295	KM69478	1095	KM72230	810
KM55973	1062	KM64014	295	KM69480	1095		
KM55974	1062	KM64016	295	KM69484	1095		
KM55980	1059	KM64018	295	KM69488	1095		
KM55981	1059	KM64020	295	KM69492	1095		
KM56104	502	KM64022	295	KM69495	1094	KM98112	1090
KM56168	501	KM64024	295	KM69498	1094	KM98112P	1090
KM56170	501	KM64026	295	KM69502	1094	KM98116	1090
KM56172	501	KM64028	295	KM69518	1095	KM98116P	1090
KM56174	501	KM64030	295	KM69524	1125	KM98120	1090
KM56284	502	KM64032	295	KM69530	972	KM98120P	1090
KM56312	502	KM64034	295	KM69534	972	KM98150	1001, 108
KM56318	502	KM64227	269	KM69538	972	KM98160	991, 108

## KM6

## KM7

## KM9



KM98170.....991, 1087  
 KM98180.....991, 1088  
 KM98190.....1001, 1088  
 KM98195.....1089  
 KM98200.....1098

## MDP

MDP-28K.....762  
 MDP-36K.....762  
 MDP-40K.....762  
 MDP-44K.....762  
 MDP-48K.....762  
 MDP-52K.....762  
 MDP-56K.....762  
 MDP-60K.....762

## O

O358PRA.....463  
 OS100102.....1066  
 OS100182.....1066  
 OS100198.....1066  
 OS100199.....1066  
 OS100200.....1066  
 OS100201.....1066  
 OS100202.....1066  
 OS100203.....1066  
 OS100204.....1066  
 OS100205.....1066  
 OS100206.....1066  
 OS100207.....1066  
 OS100208.....1066  
 OS100209.....1066  
 OS100210.....1066  
 OS100211.....1066  
 OS100212.....1066  
 OS100213.....1067  
 OS100214.....1066  
 OS100215.....1066  
 OS100216.....1066  
 OS100217.....1066  
 OS100218.....1066  
 OS100219.....1066  
 OS100220.....1066  
 OS100221.....1066  
 OS100222.....1067  
 OS100223.....1067  
 OS100224.....1066  
 OS100225.....1066  
 OS100226.....1066  
 OS100227.....1066  
 OS100228.....1066  
 OS100229.....1066  
 OS100230.....1066  
 OS100231.....1066  
 OS100232.....1066  
 OS100234.....1066  
 OS100235.....1066  
 OS100236.....1066  
 OS100237.....1066  
 OS100238.....1066  
 OS100239.....1066  
 OS100240.....1066  
 OS100241.....1066  
 OS100242.....1066  
 OS100250.....1066  
 OS100251.....1067  
 OS100252.....1067  
 OS100253.....1067  
 OS100254.....1067  
 OS100255.....1067  
 OS100256.....1067

OS100257.....1067  
 OS100258.....1067  
 OS100259.....1067  
 OS100260.....1067  
 OS100261.....1067  
 OS100262.....1067  
 OS100263.....1067  
 OS100264.....1067  
 OS100270.....1067  
 OS100271.....1067  
 OS100272.....1067  
 OS100273.....1067  
 OS100274.....1067  
 OS100275.....1067  
 OS100276.....1067  
 OS100277.....1067  
 OS100280.....1067  
 OS100281.....1067  
 OS100282.....1067  
 OS100283.....1067  
 OS100284.....1067  
 OS100285.....1067  
 OS100286.....1067  
 OS100287.....1067  
 OS100288.....1067  
 OS100289.....1067  
 OS100290.....1066  
 OS100291.....1066  
 OS100292.....1066  
 OS100293.....1066  
 OS100294.....1066  
 OS100295.....1067  
 OS100296.....1067  
 OS100297.....1067

## P

P356PRA.....463  
 P358PRA.....463  
 P15128.....1142  
 P29862.....1142  
 P29863.....1142  
 P29864.....1142  
 P30186.....1142  
 P35235.....1142  
 P35236.....1142  
 P37304.....333  
 P37305.....334  
 P37306.....335  
 P37308.....330  
 P37309.....330  
 P37310.....329  
 P37311.....329  
 P37312.....329  
 P37313.....329  
 P37314.....329  
 P37315.....333  
 P37316.....331  
 P37317.....331  
 P37318.....329  
 P37319.....329, 377  
 P37320.....332  
 P37321.....332  
 P37322.....332  
 P37323.....332  
 P37324.....332  
 P37325.....332  
 P37326.....332  
 P37327.....330  
 P37328.....330  
 P37329.....331  
 P37330.....331  
 P37331.....333  
 P37332.....333

P37333.....333  
 P37334.....333  
 P37335.....332  
 P37336.....333  
 P37337.....333  
 P37338.....333  
 P37339.....335  
 P37341.....335  
 P37342.....335  
 P37343.....335  
 P37344.....335  
 P37345.....335  
 P37346.....335  
 P37347.....335  
 P37348.....335  
 P37349.....335  
 P37350.....335  
 P37351.....336  
 P37352.....336  
 P37353.....336  
 P37354.....336  
 P37355.....336  
 P37356.....336  
 P37357.....336  
 P37358.....335  
 P37361.....337  
 P37372.....336  
 P37373.....336  
 P37374.....336  
 P37375.....336  
 P37376.....336  
 P37377.....336  
 P37378.....336  
 P37379.....336  
 P37380.....336  
 P37381.....336  
 P37382.....336  
 P37383.....336  
 P37384.....336  
 P37385.....336  
 P37387.....336  
 P37388.....336  
 P37389.....336  
 P37390.....336  
 P37391.....337  
 P37392.....337  
 P37393.....337  
 P37394.....337  
 P37395.....337  
 P37396.....337  
 P37397.....337  
 P37398.....337  
 P37399.....337  
 P37400.....337  
 P37401.....337  
 P37402.....337  
 P37403.....337  
 P37404.....337  
 P37419.....333  
 P37420.....335  
 P37421.....335  
 P37422.....335  
 P37423.....335  
 P37424.....335  
 P37425.....335  
 P37426.....335  
 P37427.....336  
 P37428.....336  
 P37429.....336  
 P37430.....336  
 P37431.....336  
 P37432.....336  
 P37433.....336  
 P37435.....337  
 P37436.....337

P37437.....337  
 P37447.....337  
 P37448.....337  
 P37449.....337  
 P37450.....337  
 P37451.....337  
 P37452.....337  
 P37453.....337  
 P37454.....337  
 P37455.....337  
 P37456.....337  
 P37457.....337  
 P37458.....337  
 P37485.....336  
 P37486.....336  
 P37487.....336  
 P37544.....335  
 P37545.....334  
 P37564.....335  
 P37593.....334  
 P37872.....331  
 PI-104.....1165  
 PI-128.....1166

## S

S358PRA.....463

## W

W356PXA.....463  
 W358PRA.....463  
 W358PXA.....463

